

AJCQ10ACF

GE® Series 115 Volt Built-in Cool-only Room Air Conditioner

WALL CASE DIMENSIONS AND INSTALLATION INFORMATION (IN INCHES)

Note: When installing slide-out chassis units in through-the-wall applications, keep louvers free. Do not restrict air flow areas.

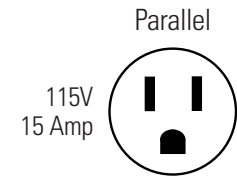
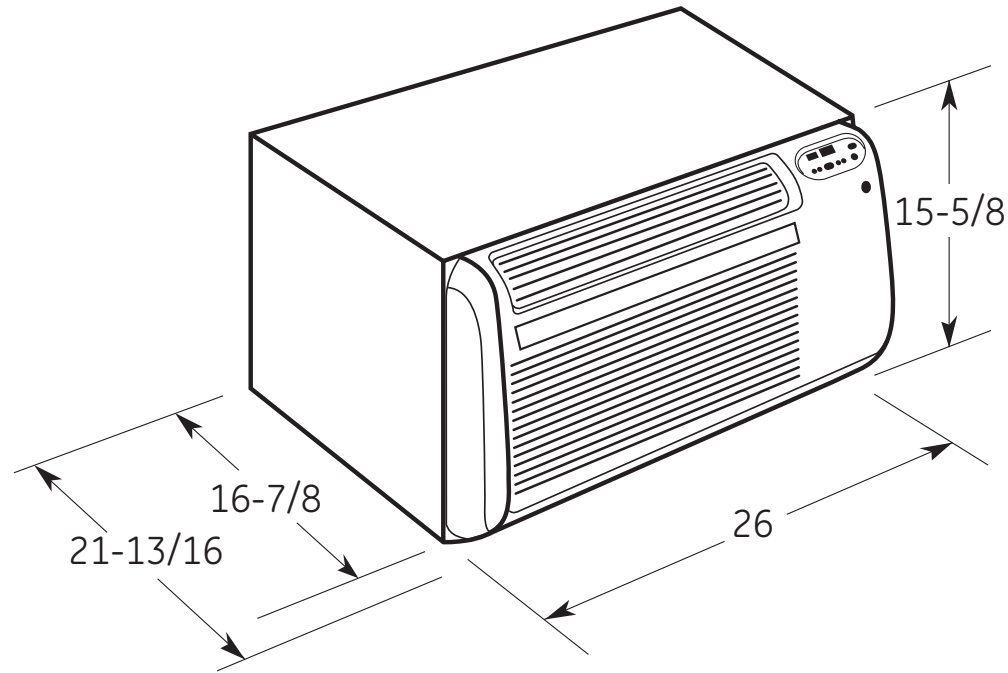

GE APPLIANCES

For answers to your Monogram, GE Profile™ Series or GE® Series appliance questions, visit our website at geappliances.com or call GE Answer Center® service, 800.626.2000.



Total volume and shelf area are calculated by the Association of Home Appliance Manufacturers' standards.



Listed by Underwriters Laboratories

Specification Revised 10/15

AJCQ10ACF

GE® Series 115 Volt Built-in Cool-only Room Air Conditioner

DIMENSIONS (IN INCHES)

INSTALLATION INFORMATION: A finished opening of 26-1/8" x 15-3/4" clear of intrusions is required. Keep clearance of 4" from side walls. Brick veneer or frame walls should have wood studding surrounding case to provide firm anchoring with screws. Case can be fastened directly to brick or block walls with screws sunk in lead expansion shields.

NOTE: Units should be caulked on all four sides of case to the building exterior to assure building integrity.

WALL CASE FOR TENANT OPTION INSTALLATION

When the air conditioner is offered as a tenant option, this wall case provides protection against outside elements.

RAB48 – includes wall case, exterior grille, steel closure panel and two layers of insulation.

STANDARD WALL CASE RAB46

Solid-sided wall case fabricated of galvanized steel with baked enamel finish. Welded areas are coated with a sealing compound to help resist rust and corrosion. Polymer gasket surrounds opening to assure tight weather seal. Aluminum grille (RAG13) is included. Panels on interior and between case and grille provide weather protection prior to installation of chassis. Provide firm anchoring with screws. Case can be fastened directly to brick or block walls with screws sunk in lead expansion shields.

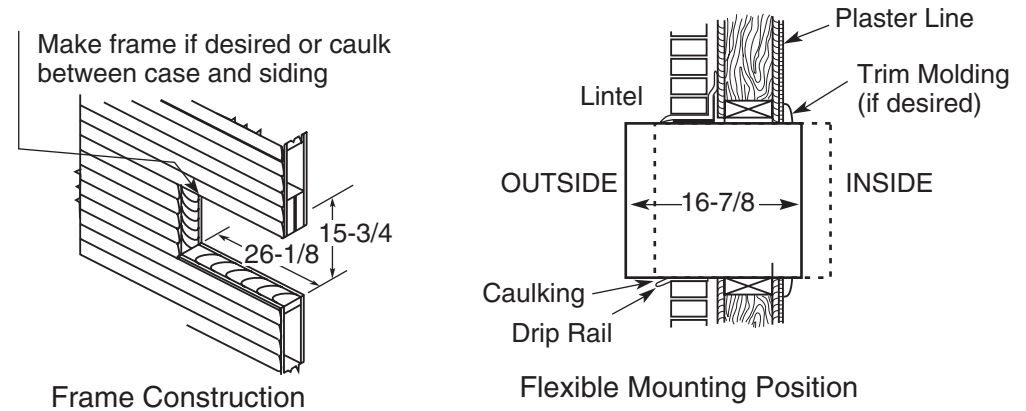

Frame Construction

Flexible Mounting Position

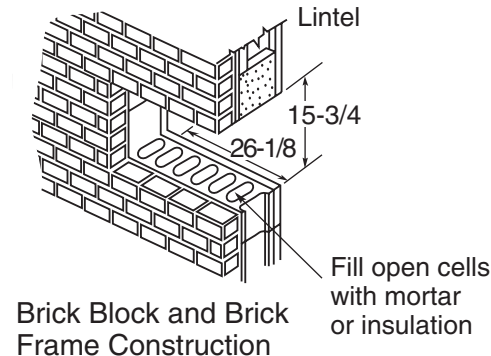

Brick Block and Brick Frame Construction



GE APPLIANCES

For answers to your Monogram, GE Profile™ Series or GE® Series appliance questions, visit our website at geappliances.com or call GE Answer Center® service, 800.626.2000.



Total volume and shelf area are calculated by the Association of Home Appliance Manufacturers' standards.



Listed by Underwriters Laboratories

Specification Revised 10/15

AJCQ10ACF

GE® Series 115 Volt Built-in Cool-only Room Air Conditioner

FEATURES AND BENEFITS

10,400 Cooling BTU

9.8 EER, 9.6 CEER

115 Volts

R-410A refrigerant

Electronic controls with remote

Electronic digital thermostat control

Filter reset

Four-way air direction

Up-front, washable air filter

3 cool / 3 fan speeds

Model AJCQ10ACF – Soft Gray

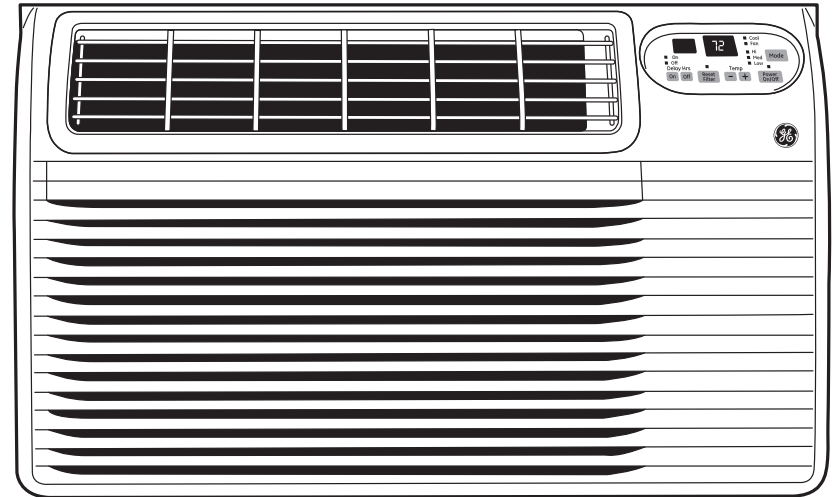

GE APPLIANCES