



BLUERIDGE®



Owner's Manual

Original Instructions

Floor Ceiling Type Air Conditioner

INVERTER

Thank you for choosing our product.
Please read this Owner's Manual carefully before operation and retain it for future reference.
If you have lost the Owner's Manual, please contact the local agent at 800-865-5931 or visit www.alpinehomeair.com.

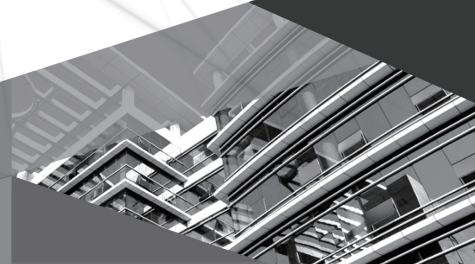



BMKH09MFCC
BMKH12MFCC
BMKH18MFCC
BMKH24MFCC

Contents

1 Safety Precautions.....	1
2 Outline of the Unit and Main Parts	2
3 Operation of remote controller.....	3
3.1 Buttons on remote controller	3
3.2 Introduction for icons on display screen.....	3
3.3 Introduction for buttons on remote controller.....	4
3.4 Function introduction for combination buttons.....	9
3.5 Operation guide.....	11
3.6 Replacement of batteries in remote controller.....	11
4 Preparative for Installation	12
4.1 Standard Accessory Parts	12
4.2 Selection of the Installation Location	12
4.3 Connection Pipe Requirement	13
4.4 Electrical Requirement	14
5 Installation of the Unit	15
5.1 Installation of the Indoor Unit.....	15
5.2 Installation of the Connection Pipe	18
5.3 Vacuum and Gas Leakage Inspection	22
5.4 Installation of the Drain Pipe	24
5.5 Electrical Wiring	27
6 Installation of Controllers	31
7 Test Running	32
7.1 Trial Operation and Testing	32
8 Troubleshooting and Maintenance	34
8.1 Troubleshooting	34
8.2 Routine Maintenance	35

1 Safety Precautions

 WARNING!	This mark indicates procedures which, if improperly performed, might lead to the death or serious injury of the user.
 CAUTION!	This mark indicates procedures which, if improperly performed, might possibly result in personal harm to the user, or damage to property.

 WARNING!	
(1).	For operating the air conditioner pleasantly, install it as outlined in this installation manual.
(2).	Connect the indoor unit and outdoor unit with the room air conditioner piping and cord available from our standard parts. This installation manual describes the correct connections using the installation set available from our standard parts.
(3).	Installation work must be performed in accordance with national wiring standards by authorized personnel only.
(4).	If refrigerant leaks while work is being carried out, ventilate the area. If the refrigerant comes in contact with a flame, it produces toxic gas.
(5).	Do not power on until all installation work is complete.
(6).	During installation, make sure that the refrigerant pipe is attached firmly before you run the compressor. Do not operate the compressor under the condition of refrigerant piping not attached properly with 2-way or 3-way valve open. This may cause abnormal pressure in the refrigeration cycle that leads to breakage and even injury.
(7).	During the pump-down operation, make sure that the compressor is turned off before you remove the refrigerant piping. Do not remove the connection pipe while the compressor is in operation with 2-way or 3-way valve open. This may cause abnormal pressure in the refrigerant cycle that leads to breakage and even injury.
(8).	When installing and relocating the air conditioner do not mix gases other than the specified refrigerant (R410A) to enter the refrigerant cycle. If air or other gas enters the refrigerant cycle, the pressure inside the cycle will rise to an abnormally high value and cause breakage, injury, etc.
(9).	This appliance can be used by children aged from 8 years and above and persons with reduced physical, sensory or mental capabilities or lack of experience and knowledge if they have been given supervision or instruction concerning use of the appliance in a safe way and understand the hazards involved. Children shall not play with the appliance. Cleaning and user maintenance shall not be made by children without supervision.
(10).	If the supply cord is damaged, it must be replaced by the manufacturer, its service agent or similarly qualified persons in order to avoid a hazard.
(11).	Correct Disposal of this product
(12).	The appliance shall not be installed in the laundry.

2 Outline of the Unit and Main Parts

Indoor

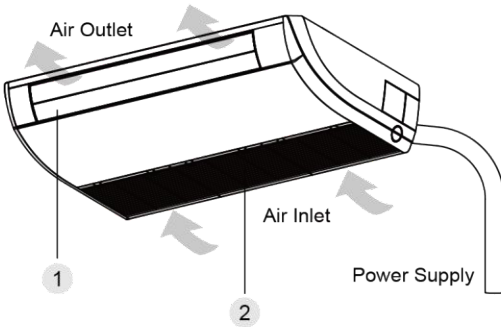

- 1. Guide louver
- 2. Air filter
- 3. Wired controller
- 4. Wireless Controller
- 5. Binding tape
- 6. Drain Pipe
- 7. Gas Pipe
- 8. Lipid Pipe
- 9. Big Handle
- 10. Front Board

Outdoor

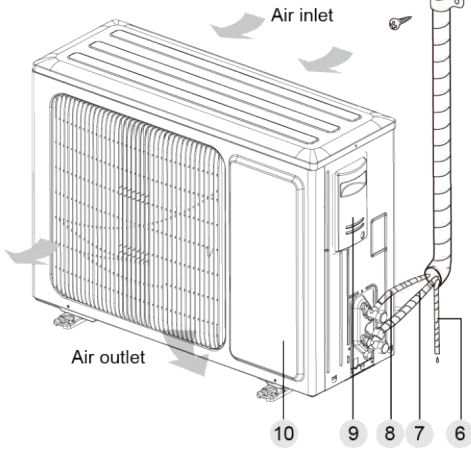
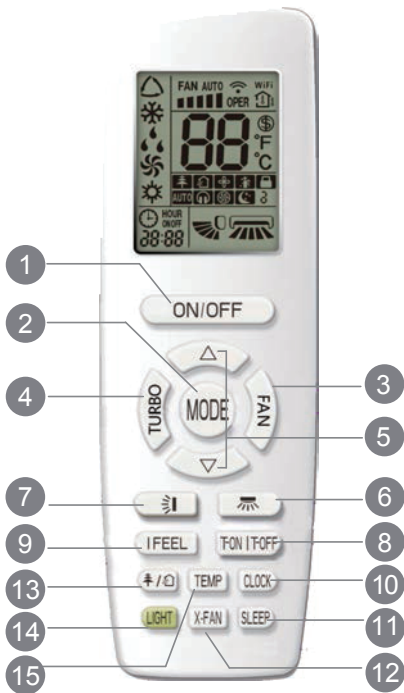

Fig.1

Notes: The connection pipe and duct for this unit should be prepared by the user.

3 Operation of remote controller

3.1 Buttons on remote controller



- 1 ON/OFF button
- 2 MODE button
- 3 FAN button
- 4 TURBO button
- 5 ▲ / ▼ button
- 6 button
- 7 button
- 8 T-ON / T-OFF button
- 9 I FEEL button
- 10 CLOCK button
- 11 SLEEP button
- 12 X-FAN button (Note: X-FAN is the same with BLOW.)
- 13 button
- 14 LIGHT button
- 15 TEMP button

3.2 Introduction for icons on display screen

Operation mode

- Auto mode
- Cool mode
- Dry mode
- Fan mode
- Heat mode

Icons and Functions:

- Set fan speed (No fan speed. It's displayed only after turning it on.)
- Send signal
- WiFi { This is a general remote controller. Some models have this function while some do not. Please refer to the actual models. Switch temperature displaying type on the unit's display
- 8°C heating function
- I feel
- Child lock
- Sleep mode
- Turbo mode
- Clock
- T-ON / T-OFF
- Set time
- Quiet
- Left & right swing
- Up & down swing

Additional Functions:

- Healthy mode
- Scavenging functions
- X-FAN function

3.3 Introduction for buttons on remote controller

Note:

- This is a general use remote controller, it could be used for the air conditioners with multifunction; For some function, which the model doesn't have, if press the corresponding button on the remote controller that the unit will keep the original running status.
- After putting through the power, the air conditioner will give out a sound. Operation indicator "⏻" is ON (red indicator, the colour is different for different models). After that, you can operate the air conditioner by using remote controller.
- Under on status, pressing the button on the remote controller, the signal icon "📶" on the display of remote controller will blink once and the air conditioner will give out a "de" sound, which means the signal has been sent to the air conditioner.

1 ON/OFF button

Press this button to turn on the unit. Press this button again to turn off the unit.

2 MODE button

Press this button to select your required operation mode.



- When selecting auto mode, air conditioner will operate automatically according to ex-factory setting. Set temperature can't be adjusted and will not be displayed as well. Press "FAN" button can adjust fan speed. Press "📶" / "📶" button can adjust fan blowing angle.
- After selecting cool mode, air conditioner will operate under cool mode. Cool indicator "❄️" on indoor unit is ON. (This indicator is not available for some models.) Press "▲" or "▼" button to adjust set temperature. Press "FAN" button to adjust fan speed. Press "📶" / "📶" button to adjust fan blowing angle.
- When selecting dry mode, the air conditioner operates at low speed under dry mode. Dry indicator "💧" on indoor unit is ON. (This indicator is not available for some models.) Under dry mode, fan speed can't be adjusted. Press "📶" / "📶" button to adjust fan blowing angle.
- When selecting fan mode, the air conditioner will only blow fan, no cooling and no heating. All indicators are OFF. Press "FAN" button to adjust fan speed. Press "📶" / "📶" button to adjust fan blowing angle.
- When selecting heating mode, the air conditioner operates under heat mode. Heat indicator "☀️" on indoor unit is ON. (This indicator is not available for some models.) Press "▲" or "▼" button to adjust set temperature. Press "FAN" button to adjust fan speed. Press "📶" / "📶" button to adjust fan blowing angle. (Cooling only unit won't receive heating mode signal. If setting heat mode with remote controller, press ON/OFF button can't start up the unit).

Note:

- For preventing cold air, after starting up heating mode, indoor unit will delay 1~5 minutes to blow air (actual delay time is depend on indoor ambient temperature).
- Set temperature range from remote controller: 16~30°C (61-86°F);
Fan speed: auto, low speed, medium speed, high speed.

3 FAN button

Pressing this button can set fan speed circularly as: auto (AUTO), low(■|), medium (■|■), high(■|■|■).



Note:

- Under AUTO speed, air conditioner will select proper fan speed automatically according to ex-factory setting.
- It's Low fan speed under Dry mode.

4 TURBO button

Under COOL or HEAT mode, press this button to turn to quick COOL or quick HEAT mode. "⌚" icon is displayed on remote controller. Press this button again to exit turbo function and "⌚" icon will disappear.

If start this function, the unit will run at super-high fan speed to cool or heat quickly so that the ambient temp. approaches the preset temp. as soon as possible.

5 ▲ / ▼ button



- Press "▲" or "▼" button once increase or decrease set temperature 1°C (°F). Holding "▲" or "▼" button, 2s later, set temperature on remote controller will change quickly. On releasing button after setting is finished, temperature indicator on indoor unit will change accordingly. (Temperature can't be adjusted under auto mode)
- When setting T-ON, T-OFF or CLOCK, press "▲" or "▼" button to adjust time. (Refer to CLOCK, T-ON, T-OFF buttons)

6  button

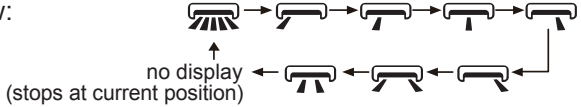
Press this button can select left & right swing angle. Fan blow angle can be selected circularly as below:











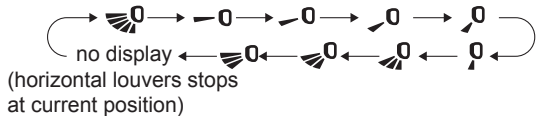

Note:

- Press this button continuously more than 2s, the main unit will swing back an forth from left to right, and then loosen the button, the unit will stop swinging and present position of guide louver will be kept immediately.
- Under swing left and right mode, when the status is switched from off to , if press this button again 2s later,  status will switch to off status directly; if press this button again within 2s, the change of swing status will also depend on the circulation sequence stated above.
- This function is applicable to partial of models.





7  button

Press this button can select up & down swing angle. Fan blow angle can be selected circularly as below:











- When selecting "", air conditioner is blowing fan automatically. Horizontal louver will automatically swing up & down at maximum angle.
- When selecting "、、、、", air conditioner is blowing fan at fixed position. Horizontal louver will stop at the fixed position.
- When selecting "、、", air conditioner is blowing fan at fixed angle. Horizontal louver will send air at the fixed angle.
- Hold " " button above 2s to set your required swing angle. When reaching your required angle, release the button.

Note:









- "、、 " may not be available. When air conditioner receives this signal, the air conditioner will blow fan automatically.
- Press this button continuously more than 2s, the main unit will swing back an forth from up to down, and then loosen the button, the unit will stop swinging and present position of guide louver will be kept immediately.
- Under swing up and down mode, when the status is switched from off to , if press this button again 2s later,  status will switch to off status directly; if press this button again within 2s, the change of swing status will also depend on the circulation sequence stated above.

8 T-ON / T-OFF button

● T-ON button

"T-ON" button can set the time for timer on. After pressing this button, " icon disappears and the word "ON" on remote controller blinks. Press " or " button to adjust T-ON setting. After each pressing " or " button, T-ON setting will increase or decrease 1min. Hold " or " button, 2s later, the time will change quickly until reaching your required time. Press "T-ON" to confirm it. The word "ON" will stop blinking. " icon resumes displaying. Cancel T-ON: Under the condition that T-ON is started up, press "T-ON" button to cancel it.



● T-OFF button

"T-OFF" button can set the time for timer off. After pressing this button, " icon disappears and the word "OFF" on remote controller blinks. Press " or " button to adjust T-OFF setting. After each pressing " or " button, T-OFF setting will increase or decrease 1min. Hold " or " button, 2s later, the time will change quickly until reaching your required time. Press "T-OFF" word "OFF" will stop blinking. " icon resumes displaying. Cancel T-OFF. Under the condition that T-OFF is started up, press "T-OFF" button to cancel it.

Note:

- Under on and off status, you can set T-OFF or T-ON simultaneously.
- Before setting T-ON or T-OFF, please adjust the clock time.
- After starting up T-ON or T-OFF, set the constant circulating valid. After that, air conditioner will be turned on or turned off according to setting time. ON/OFF button has no effect on setting. If you don't need this function, please use remote controller to cancel it.

9 I FEEL button

Press this button to start I FEEL function and " will be displayed on the remote controller. After this function is set, the remote controller will send the detected ambient temperature to the controller and the unit will automatically adjust the indoor temperature according to the detected temperature. Press this button again to close I FEEL function and " will disappear.

- Please put the remote controller near user when this function is set. Do not put the remote controller near the object of high temperature or low temperature in order to avoid detecting inaccurate ambient temperature. When I FEEL function is turned on, the remote controller should be put within the area where indoor unit can receive the signal sent by the remote controller.

10 CLOCK button

Press this button to set clock time. "🕒" icon on remote controller will blink. Press "▲" or "▼" button within 5s to set clock time. Each pressing of "▲" or "▼" button, clock time will increase or decrease 1 minute. If hold "▲" or "▼" button, 2s later, time will change quickly. Release this button when reaching your required time. Press "CLOCK" button to confirm the time. "🕒" icon stops blinking.

Note:

- Clock time adopts 24-hour mode.
- The interval between two operation can't exceeds 5s. Otherwise, remote controller will quit setting status. Operation for T-ON/T-OFF is the same.

11 SLEEP button

Under COOL, or HEAT mode, press this button to start up sleep function. "🌙" icon is displayed on remote controller. Press this button again to cancel sleep function and "🌙" icon will disappear. After powered on, Sleep Off is defaulted. After the unit is turned off, the Sleep function is canceled. In this mode, the time of time can be adjusted. Under Fan、 DRY and Auto modes, this function is not available.

12 X-FAN button

Pressing this button in COOL or DRY mode, the icon "🌀" is displayed and the indoor fan will continue operation for a few minutes in order to dry the indoor unit even though you have turned off the unit. After energization, X-FAN OFF is defaulted. X-FAN is not available in AUTO, FAN or HEAT mode. This function indicates that moisture on evaporator of indoor unit will be blowed after the unit is stopped to avoid mould.

- Having set X FAN function on: After turning off the unit by pressing ON/OFF button indoor fan will continue running for about a few minutes. at low speed. In this period, press X-FAN button to stop indoor fan directly.
- Having set X FAN function off: After turning off the unit by pressing ON/OFF button, the complete unit will be off directly.

13 🏠/🌿 button

Press this button to achieve the on and off of healthy and scavenging functions in operation status. Press this button for the first time to start scavenging function; LCD displays "🏠". Press the button for the second time to start healthy and scavenging functions simultaneously; LCD displays "🏠" and "🌿". Press this button for the third time to quit healthy and scavenging functions simultaneously. Press the button for the fourth time to start healthy function; LCD display "🌿". Press this button again to repeat the operation above.

- This function is applicable to partial of models.

14 LIGHT button

Press this button to turn off display light on indoor unit. "☹️" icon on remote controller disappears. Press this button again to turn on display light. "☹️" icon is displayed.

15 TEMP button

By pressing this button, you can see indoor set temperature, indoor ambient temperature or outdoor ambient temperature on indoor unit's display. The setting on remote controller is selected circularly as below:

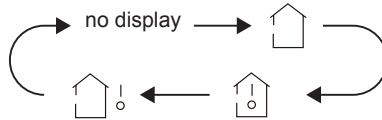

- When selecting "🏠" or no display with remote controller, temperature indicator on indoor unit displays set temperature.
- When selecting "🏠🌡️" with remote controller, temperature indicator on indoor unit displays indoor ambient temperature.
- When selecting "🏠🌡️!" with remote controller, temperature indicator on indoor unit displays outdoor ambient temperature.

Note:

- Outdoor temperature display is not available for some models. At that time, indoor unit receives "🏠🌡️!" signal, while it displays indoor set temperature.
- It's defaulted to display set temperature when turning on the unit. There is no display in the remote controller.
- Only for the models whose indoor unit has dual-8 display.
- When selecting displaying of indoor or outdoor ambient temperature, indoor temperature indicator displays corresponding temperature and automatically turn to display set temperature after three or five seconds.

3.4 Function introduction for combination buttons**Energy-saving function**

Under cooling mode, press "TEMP" and "CLOCK" buttons simultaneously to start up or turn off energy-saving function. When energy-saving function is started up, "SE" will be shown on remote controller, and air conditioner will adjust the set temperature automatically according to ex-factory setting to reach to the best energy-saving effect. Press "TEMP" and "CLOCK" buttons simultaneously again to exit energy-saving function.

Note:

- Under energy-saving function, fan speed is defaulted at auto speed and it can't

be adjusted.

- Under energy-saving function, set temperature can't be adjusted. Press "TURBO" button and the remote controller won't send signal.
- Sleep function and energy-saving function can't operate at the same time. If energy-saving function has been set under cooling mode, press sleep button will cancel energy-saving function. If sleep function has been set under cooling mode, start up the energy-saving function will cancel sleep function.

8°C heating function

Under heating mode, press "TEMP" and "CLOCK" buttons simultaneously to start up or turn off 8°C heating function. When this function is started up, "Ⓢ" and "8°C" will be shown on remote controller, and the air conditioner keep the heating status at 8°C. Press "TEMP" and "CLOCK" buttons simultaneously again to exit 8°C heating function.

Note:

- Under 8°C heating function, fan speed is defaulted at auto speed and it can't be adjusted.
- Under 8°C heating function, set temperature can't be adjusted. Press "TURBO" button and the remote controller won't send signal.
- Sleep function and 8°C heating function can't operate at the same time. If 8°C heating function has been set under cooling mode, press sleep button will cancel 8°C heating function. If sleep function has been set under cooling mode, start up the 8°C heating function will cancel sleep function.
- Under °F temperature display, the remote controller will display 46 °F heating.

Child lock function

Press "▲" and "▼" simultaneously to turn on or turn off child lock function. When child lock function is on, "🔒" icon is displayed on remote controller. If you operate the remote controller, the "🔒" icon will blink three times without sending signal to the unit.

Temperature display switchover function

Under OFF status, press "▼" and "MODE" buttons simultaneously to switch temperature display between °C and °F.

WIFI Function

Press "MODE" and "TURBO" button simultaneously to turn on or turn off WIFI function. When WIFI function is turned on, the "WiFi" icon will be displayed on remote controller; Long press "MODE" and "TURBO" buttons simultaneously for 10s, remote controller will send WIFI reset code and then the WIFI function will be turned on. WIFI function is defaulted ON after energization of the remote controller.

- This function is only available for some models.

About Back-lighting Function

The unit lights for 4s when energizing for the first time, and 3s for later press.

3.5 Operation guide

1. After putting through the power, press "ON/OFF" button on remote controller to turn on the air conditioner.
2. Press "MODE" button to select your required mode: AUTO, COOL, DRY, FAN, HEAT.
3. Press "▲" or "▼" button to set your required temperature. (Temperature can't be adjusted under auto mode).
4. Press "FAN" button to set your required fan speed: auto, low speed, medium speed, high speed.
5. Press "↻" button to select fan blowing angle.

3.6 Replacement of batteries in remote controller

1. Lift the cover along the direction of arrow (as shown in Fig 1 ①).
2. Take out the original batteries (as shown in Fig 1 ②).
3. Place two 7# (AAA 1.5V) dry batteries, and make sure the position of "+" polar and "-" polar is correct (as shown in Fig 2 ③).
4. Reinstall the cover (as shown in Fig 2 ④).

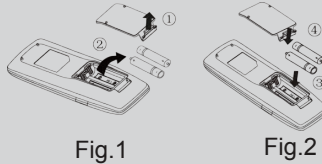

Fig.1

Fig.2

NOTICE









- During operation, point the remote control signal sender at the receiving window on indoor unit.
- The distance between signal sender and receiving window should be no more than 26 ft, and there should be no obstacles between them.
- Signal may be interfered easily in the room where there is fluorescent lamp or wireless telephone; remote controller should be close to indoor unit during operation.
- Replace new batteries of the same model when replacement is required.
- When you don't use remote controller for a long time, please take out the batteries.
- If the display on remote controller is fuzzy or there's no display, please replace batteries.

4 Preparative for Installation



4.1 Standard Accessory Parts

The standard accessory parts listed below are furnished and should be used as required.

Table 1

Indoor Unit Accessories				
No.	Name	Appearance	Q'ty	Usage
1	Nut with Washer		8	To fix the hook on the cabinet of the unit.
2	Wireless Controller + Battery		1+2	To control the indoor unit
3	Insulation		1	To insulate the gas pipe
4	Insulation		1	To insulate the liquid pipe
5	Installation Paperboard		2	To insulate the drain pipe
6	Fastener		4	To fasten the sponge
7	Nut		1	To connect gas pipe
8	Nut		1	To connect liquid pipe

4.2 Selection of the Installation Location

 WARNING!	
The unit must be installed where strong enough to withstand the weight of the unit and fixed securely otherwise the unit would topple or fall off.	
 CAUTION!	
①.	Do not install where there is a danger of combustible gas leakage.
②.	Do not install the unit near heat source, steam, or flammable gas.
③.	Children under 10 years old must be supervised not to operate the unit.

Decide the installation location with the customer as follows:

4.2.1 Indoor Unit

- (1). Install the unit at a place where is strong enough to withstand the weight of the unit.
- (2). The air inlet and outlet of the unit should never be clogged so that the airflow can reach every corner of the room.
- (3). Leave service space around the unit as required in Fig. 2

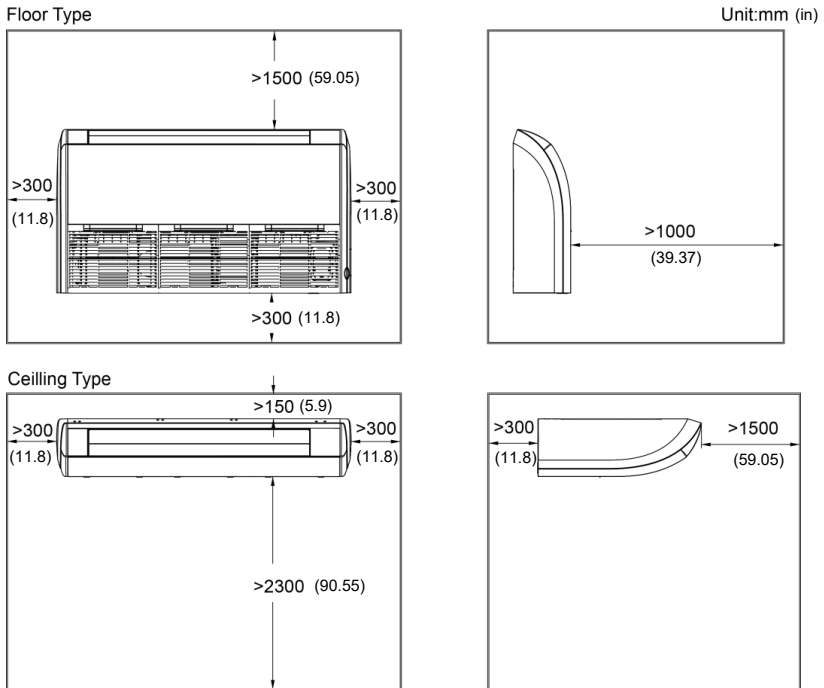

Fig. 2

- (4). Install the unit where the drain pipe can be easily installed.
- (5). The space from the unit to the ceiling should be kept as much as possible so as for more convenient service.

4.3 Connection Pipe Requirement



The maximum length of the connection pipe is listed in the Table below. Do not place the units between which the distance exceeds the maximum length of the connection pipe.

Table 2

Model \ Item	Size of Fitting Pipe(Inch)		Max. Pipe Length (m)	Max. Height Difference between Indoor Unit and Outdoor Unit (m)	Indoor unit Drainage pipe(Outer Diameter × wall thickness) (in)
	Liquid	Gas			
BMKH09MFCC	1/4	3/8	65	32	Φ17×0.068
BMKH12MFCC	1/4	1/2	65	32	Φ17×0.068
BMKH18MFCC	1/4	1/2	65	32	Φ17×0.068
BMKH24MFCC	3/8	5/8	65	32	Φ17×0.068

- (1). The connecting pipe should be thermally insulated properly.
- (2). The pipe wall thickness shall be .019-.039 in and the pipe wall shall be able to withstand the pressure of 6.0 MPa. The longer the connecting pipe, the lower the cooling and heating effect performs.
- (3).The pipe wall thickness shall be .019-.039 in and the pipe wall shall be able to withstand the pressure of 6.0 MPa. The longer the connecting pipe, the lower the cooling and heating effect performs.

4.4 Electrical Requirement

Electric Wire Size and Fuse Capacity.

Table 3

Indoor Units	Power Supply	Fuse Capacity	Min. Power Supply Cord
	V/Ph/Hz	A	
9~24k	208/230V~60Hz	5	18AWG(0.82mm ²)

Notes:

- ①. The fuse is located on the main board.
- ②. Install the disconnect device with a contact gap of at least 3 mm in all poles nearby the units (Both indoor unit and outdoor unit).The appliance must be positioned so that the plug is accessible.
- ③. The specifications of the power cable listed in the Table above are determined based on the maximum power (maximum amps) of the unit.
- ④. The specifications of the power cable listed in the Table above are applied to the conduit-guarded multi-wire copper cable (like, YJV copper cable, consisting of PE insulated wires and a PVC cable jacket) used at 40°C(104°F) and resistible to 90°C(194°F) (see IEC 60364-5-52). If the working condition changes, they should be modified according to the related national standard.

5 Installation of the Unit

5.1 Installation of the Indoor Unit

5.1.1 Indoor unit dimension

⚠ WARNING !

- ①. Install the indoor unit in a location which can withstand a load of at least five times the weight of the main unit and which will not amplify sound or vibration.
- ②. If the installation location is not strong enough, the indoor unit may fall and cause injuries.
- ③. If the job is done with the panel frame only, there is a risk that the unit will come loose. Please take care.

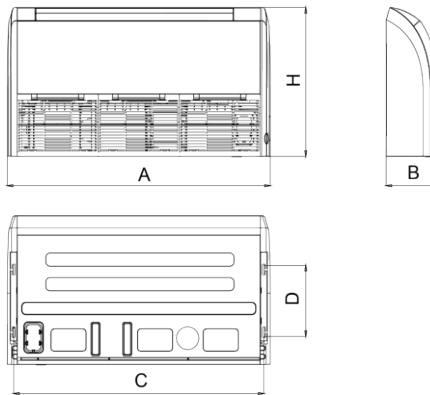

Fig. 3

Table 4

Unit: in

Model	A	B	C	D	H
BMKH09MFCC	34.25	9.25	31.96	12.51	26.18
BMKH12MFCC					
BMKH18MFCC					
BMKH24MFCC	47.24	9.25	44.96	12.51	26.18

5.1.2 Preparation for Installing the Indoor Unit

- (1). Open the air inlet grille and the screw cover, and remove the screws.
- (2). Release the claws in the 3 places indicated.
- (3). Release the center hook and remove the front panel.
- (4). Release the claws in the 2 or 3 places indicated and remove the electric component cover.

5.1.3 Indoor Unit Installation

- (1). Determine the location of the hanger through the paper template, and then remove the paper template.

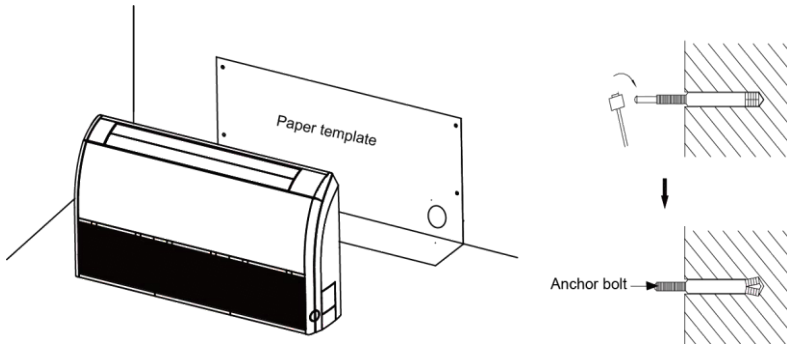

Fig. 4

- (2). Insert the anchor bolts into the drilled holes, and drive the pins completely into the anchor bolts with a hammer.
- (3). Remove the right and left side panels.
- (4). Put the hanger bolt into the clasp of the indoor unit and tighten screws on the hanger to prevent the indoor unit from moving.

- (5). Adjust the height of the unit to make the drain pipe slant slightly downward so that the drainage will become much smoother.

◆Floor type

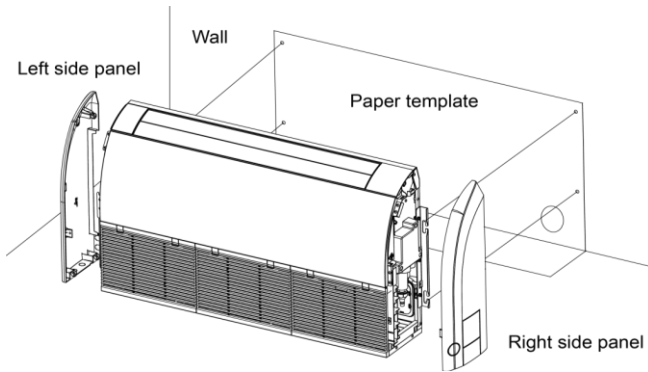

Fig. 5

◆Ceiling type

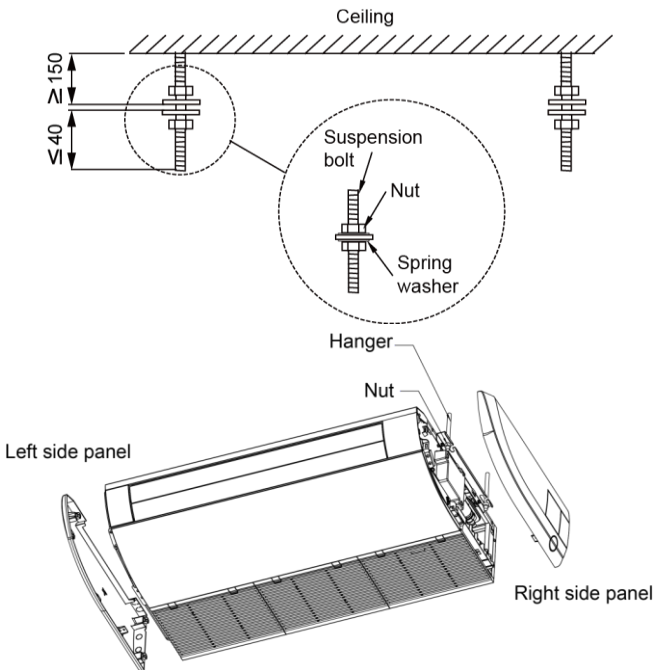

Fig. 6

- (6). Reinstall and tighten the right and left side panel.

5.1.4 Leveling

The water level test must be done after installing the indoor unit to make the unit horizontal, as shown below.

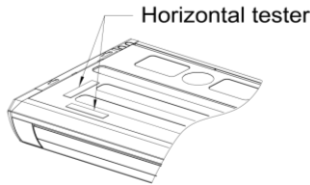

Fig. 7

5.2 Installation of the Connection Pipe

5.2.1 Flare Processing

- (1). Cut the connection pipe with the pipe cutter and remove the burrs.
- (2). Hold the pipe downward to prevent cuttings from entering the pipe.
- (3). Remove the flare nuts at the stop valve of the outdoor unit and inside the accessory bag of the indoor unit, then insert them to the connection pipe, after that, flare the connection pipe with a flaring tool.
- (4). Check if the flare part is spread evenly and there are no cracks (see Fig. 8).

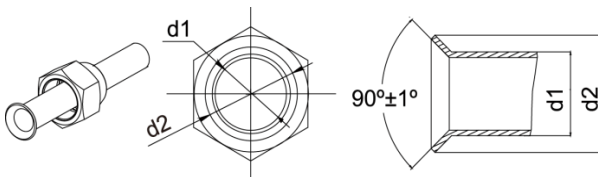

Fig. 8

5.2.2 Bending Pipes

- (1). The pipes are shaped by your hands. Be careful not to collapse them.

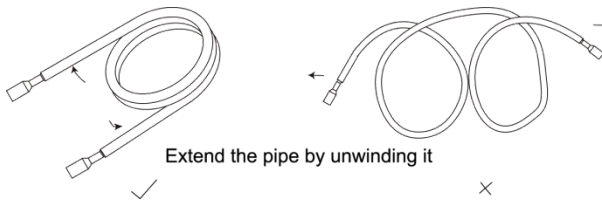
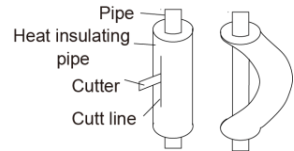

Fig. 9

- (2). Do not bend the pipes in an angle more than 90° .
- (3). When pipes are repeatedly bent or stretched, the material will harden, making it difficult to bend or stretch them any more. Do not bend or stretch the pipes more than three times.
- (4). When bending the pipe, do not bend it as is. The pipe will be collapsed. In this case, cut the heat insulating pipe with a sharp cutter as shown in Fig. 10, and bend it after exposing the pipe. After bending the pipe as you want, be sure to put the heat insulating pipe back on the pipe, and secure it with tape.



CAUTION!

- | |
|--|
| ①. To prevent breaking of the pipe, avoid sharp bends. Bend the pipe with a radius of curvature of 150 mm or over. |
| ②. If the pipe is bent repeatedly at the same place, it will break. |

5.2.3 Connecting the Pipe at the Indoor Unit Side

Detach the caps and plugs from the pipes.



- ①. Be sure to apply the pipe against the port on the indoor unit correctly. If the centering is improper, the flare nut cannot be tightened smoothly. If the flare nut is forced to turn, the threads will be damaged.
- ②. Do not remove the flare nut until the connection pipe is to be connected so as to prevent dust and impurities from coming into the pipe system.

When connecting the pipe to the unit or removing it from the unit, please do use both the spanner and the torque wrench. (Fig. 11)

When connecting, smear both inside and outside of the flare nut with refrigeration oil, screw it hand tight and then tighten it with the spanner.

Refer to Table 7 to check if the wrench has been tightened properly (too tight would mangle the nut and lead to leakage).

Examine the connection pipe to see if it leaks, then take the treatment of heat insulation, as shown in the Fig. 12.

Use the medium-sized sponge to insulate the coupler of the gas pipe. |

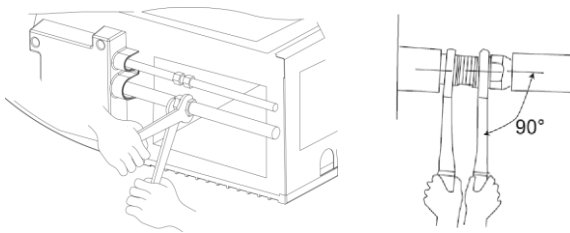

Fig. 11

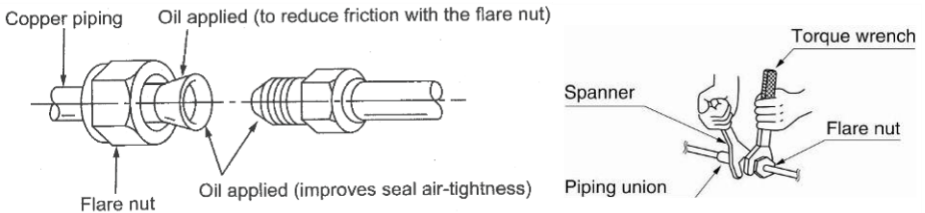

Fig. 12

Table 5 Flare nut tightening torque

Pipe Diameter	Tightening Torque
1/4" (Inch)	15-30 (N·m)
3/8" (Inch)	35-40 (N·m)
1/2" (Inch)	45-50 (N·m)
5/8" (Inch)	60-65 (N·m)
3/4" (Inch)	70-75 (N·m)
7/8" (Inch)	80-85 (N·m)

CAUTION!

Be sure to connect the gas pipe after connecting the liquid pipe completely.

5.2.4 Connecting the Pipe at the Outdoor Side Unit

Tighten the flare nut of the connection pipe at the outdoor unit valve connector. The tightening method is the same as that as at the indoor side

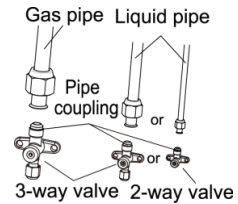

Fig. 13

5.2.5 Checking the Pipe Connections for Gas Leaking

For both indoor and outdoor unit side, check the joints for gas leaking by the use of a gas leakage detector without fail when the pipes are connected.

5.2.6 Heat Insulation on the Pipe Joints (Indoor Side Only)

Stick coupler heat insulation (large and small) to the place where connecting pipes.

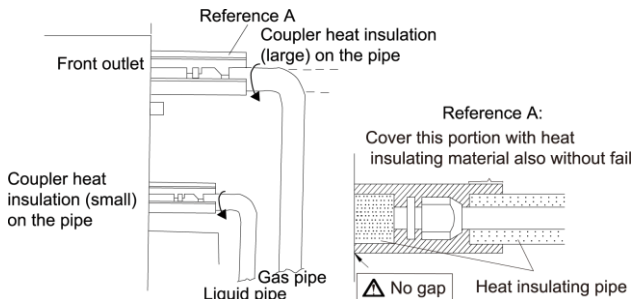

Fig. 14

5.2.7 Liquid Pipe and Drain Pipe

- (1). If the outdoor unit is installed lower than the indoor unit. (See Fig. 15)
 - 1). A drain pipe should be above ground and the end of the pipe does not dip into water. All pipes must be restrained to the wall by saddles.
 - 2). Taping pipes must be done from bottom to top.
 - 3). All pipes are bound together by tape and restrained to wall by saddles.

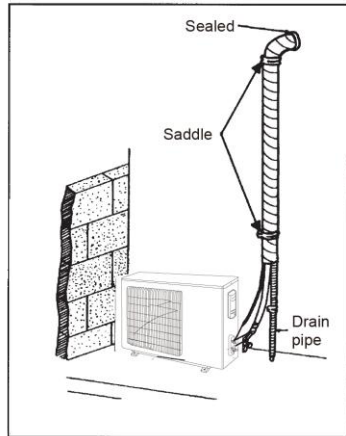

Fig. 15

- (2). If the outdoor unit is installed higher than the indoor unit.
 - 1). Taping should be done from lower to the upper part.
 - 2). All pipes are bound and taped together and also should be trapped to prevent water from returning to the room (See Fig. 16)
 - 3). Restraint all pipes to the wall with saddles.

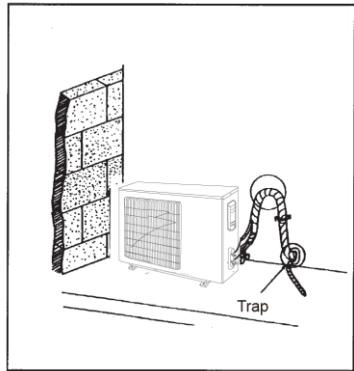

Fig. 16

5.3 Vacuum and Gas Leakage Inspection



CAUTION!

Do not purge the air with refrigerants but use a vacuum pump to vacuum the installation! There is no extra refrigerant in the outdoor unit for air purging!

5.3.1 Vacuum

- (1). Remove the caps of the liquid valve, gas valve and also the service port.
- (2). Connect the hose at the low pressure side of the manifold valve assembly to the service port of the unit's gas valve, and meanwhile the gas and liquid valves should be kept closed in case of refrigerant leak.
- (3). Connect the hose used for evacuation to the vacuum pump.
- (4). Open the switch at the lower pressure side of the manifold valve assembly and start the vacuum pump. Meanwhile, the switch at the high pressure side of the manifold valve assembly should be kept closed, otherwise evacuation would fail.
- (5). The evacuation duration depends on the unit's capacity, generally, 20 minutes for the 9k/12k/18k units, 30 minutes for the 24k units. And verify if the pressure gauge at the low pressure side of the manifold valve assembly reads -1.0Mp (-75cmHg), if not, it indicates there is leak somewhere. Then, close the switch fully and then stop the vacuum pump.
- (6). Wait for some time to see if the system pressure can remain unchanged, 5 minutes for the 9k/12k/18k/24k units. During this time, the reading of the pressure gauge at the low pressure side can not be larger than 0.005Mp (0.38cmHg).
- (7). Slightly open the liquid valve and let some refrigerant go to the connection pipe to balance the pressure inside and outside of the connection pipe, so that air will not come into the connection pipe when removing the hose. Note that the gas and liquid valve can be opened fully only after the manifold valve assembly is removed.
- (8). Place back the caps of the liquid valve, gas valve and also the service port.

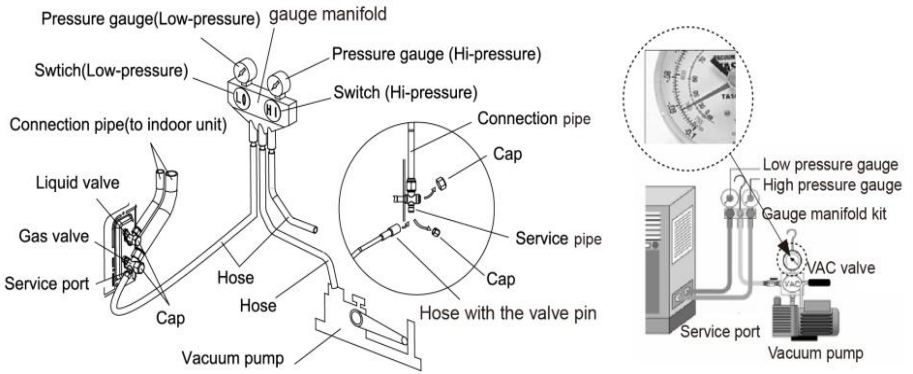

Fig. 17

Note: For the large-sized unit, it has the service port for both the gas valve and the liquid valve. During evacuation, it is available to connect two hoses of the manifold valve assembly to two service ports to quicken the evacuating speed.

5.4 Installation of the Drain Pipe

5.4.1 Precautions When Doing the Piping Work



CAUTION!

Install the drain hose in accordance with the instructions in this installation manual and keep the area warm enough to prevent condensation. Problems with the piping may lead to water leaks.

- (1). Keep piping as short as possible and slope it downwards at a gradient of at least 1/100 so that air may not remain trapped inside the pipe.
- (2). Keep pipe size equal to or greater than that of the connecting pipe.
- (3). Install the drain piping as shown and take measures against condensation. Improperly rigged piping could lead to leaks and eventually wet furniture and belongings.

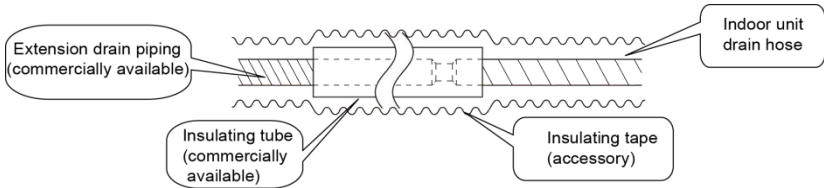

Fig. 19

- (4). Connect the drain hose.(Fig. 20)

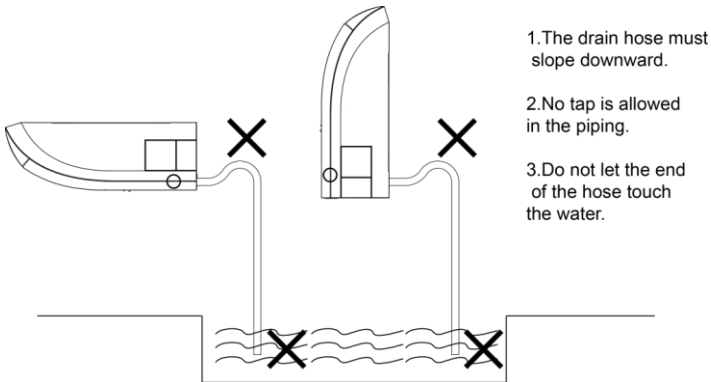

Fig. 20

5.4.2 Installing the Drain Pipes

- (1). For determining the position of the drain hose, perform the following procedures.
- (2). Insert the drain pipe to the drain outlet of the unit and then tighten the clamp securely with tape. (Fig. 21)
- (3). Connect the extension drain pipe to the drain pipe and then tighten the clamp with tape.

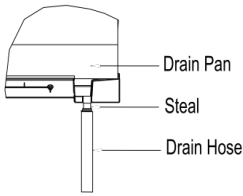

Fig. 21

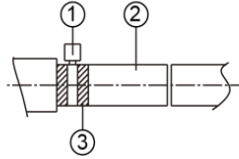

Fig. 22

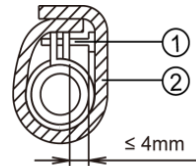

Fig. 23

Tighten the clamp until the screw head is less than 4 mm from the hose. (Fig. 22)

- ①- Metal clamp ②- Drain hose ③- Grey tape

Insulate the pipe clamp and the drain hose using heat insulation sponge. (Fig. 23)

- ①- Metal clamp ②- Insulation sponge

- (1). When drain hose requires extension, obtain an extension hose commercially available.
- (2). After connecting the local drain hose, tape the slits of the heat insulation tube.
- (3). Connect the drain hose to the local drain pipe. Position the inner connecting wire in the same direction as the piping.

5.4.3 Connecting the Drain Hose

- (1). Connect the extension auxiliary pipe to the local piping.
- (2). Prepare the local piping at the connection point for the drain pipe, as shown in the installation drawings.

Note: Be sure to place the drain hose as shown in the diagram below, in a downward sloping direction.

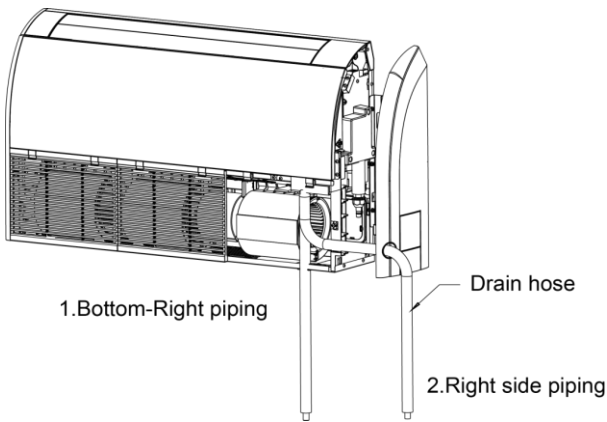

Fig. 24

5.4.4 Testing of Drain Piping

- (1). After piping work is finished, check if drainage flows smoothly.
- (2). As shown in the Figure, pour water into the drain pan from the right side to check that water flows smoothly from the drain hose.

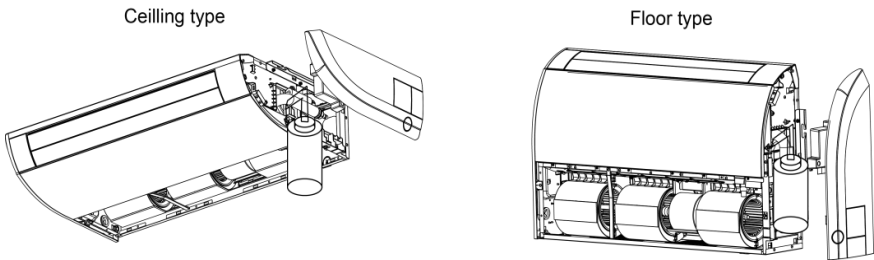



Fig. 25

5.5 Electrical Wiring

5.5.1 Wiring Precautions

 WARNING!	
①.	Before obtaining access to terminals, all supply circuits must be disconnected.
②.	The rated voltage of the unit is as shown as Table 3
③.	Before turning on, verify that the voltage is within the 185~264V range (for single phase unit) or 342~457V range (for three-phase unit).
④.	Always use a special branch circuit and install a special receptacle to supply power to the air conditioner.

- | | |
|----|---|
| ⑤. | The special branch circuit breaker is installed in the permanent wiring. Always use a circuit that can trip all the poles of the wiring and has an isolation distance of at least 3 mm between the contacts of each pole. |
| ⑥. | Perform wiring work in accordance with standards so that the air conditioner can be operated safely and positively. |
| ⑦. | Install a leakage special branch circuit breaker in accordance with the related laws and regulations and electric company standards. |



CAUTION!

- | | |
|----|--|
| ①. | The power source capacity must be the sum of the air conditioner current and the current of other electrical appliances. When the current contracted capacity is insufficient, change the contracted capacity. |
| ②. | When the voltage is low and the air conditioner is difficult to start, contact the power company to raise the voltage. |

5.5.2 Electrical Wiring

- (1). For solid core wiring (Fig. 26)
 - 1). Cut the wire end with a wire cutter or wire-cutting pliers, then strip the insulation about 25 mm (15/16").
 - 2). Using a screwdriver, remove the terminal screw(s) on the terminal board.
 - 3). Using pliers, bend the solid wire to form a loop suitable for the terminal screw.
 - 4). Shape the loop wire properly, place it on the terminal board and tighten securely with the terminal screw using a screwdriver.
- (2). For strand wiring (Fig. 26)
 - 1). Cut the wire end with a wire cutter or wire-cutting pliers, then strip the insulation about 10 mm (3/8").
 - 2). Using a screwdriver, remove the terminal screw (s) on the terminal board.
 - 3). Using a round terminal fastener or pliers, securely clamp a round terminal to each stripped wire end.
 - 4). Position the round terminal wire, and replace and tighten the terminal screw with a screwdriver.(Fig. 27)

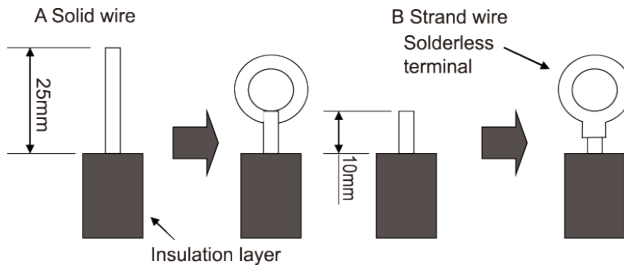

Fig. 26

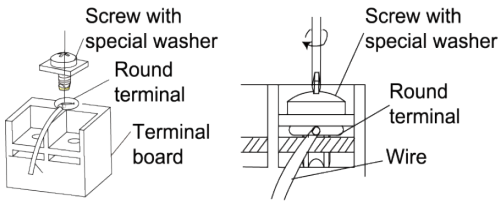

Fig. 27

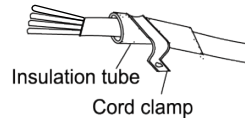

Fig. 28

(3). How to fix connection cord and power cord by cord clamp

After passing the connection cord fasten it with the cord clamp. (Fig. 28)

WARNING!

- ①. Before starting work, check that power is not being supplied to the indoor unit and outdoor unit.
- ②. Match the terminal block numbers and connection cord colors with those of the indoor unit side.
- ③. Erroneous wiring may cause burning of the electric parts.
- ④. Connect the connection cords firmly to the terminal block. Imperfect installation may cause a fire.
- ⑤. Always fasten the outside covering of the connection cord with cord clamps. (If the insulator is not clamped, electric leakage may occur.)
- ⑥. Always connect the ground wire.

- (4). Electric wiring between the indoor and outdoor units
Single-phase units (9~24k)

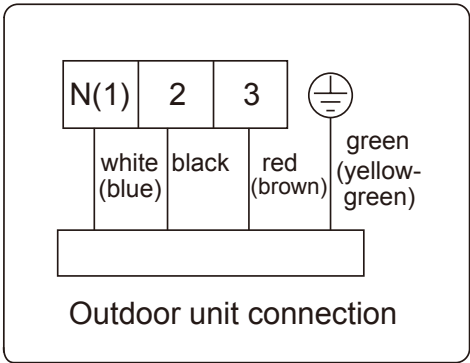

(5). Electric wiring of indoor unit side

Remove the left cover plate and the electric box cover then insert the end of the communication cord and the power cable into the terminal board.

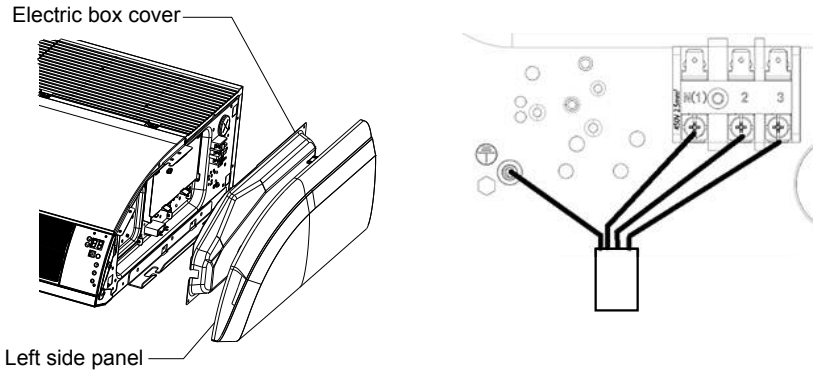

Fig. 30

⚠ CAUTION!

- | | |
|---|---|
| ① | Tighten the power cord respectively on the terminal boards with screws. Faulty connection may cause a fire. |
| ② | If the power supply are wired incorrectly, the air conditioner may be damaged. |
| ③ | Connect the indoor unit connection cord properly based on the corresponding marks as shown in Fig. 29. |
| ④ | Ground both the indoor and outdoor units by attaching a ground wire. |
| ⑤ | Unit shall be grounded in compliance with the applicable local and national codes. |

6 Installation of Controllers

Refer to the Installation Manual of the controller for more details.

7 Test Running

7.1 Trial Operation and Testing

(1). The meaning of error codes as shown below:

Table 7

Number	Error code	Error
1	E1	Compressor high pressure protection
2	E2	Indoor anti-freeze protection
3	E3	Compressor low pressure protection, refrigerant lack protection and refrigerant collecting mode
4	E4	Compressor high discharge temperature protection
5	E5	AC over-current protection
6	E6	Communication error
7	E7	Mode conflict
8	E8	Anti-high temperature protection
9	F1	Indoor ambient temperature sensor is open/short circuited
10	F2	Indoor evaporator temperature sensor is open/short circuited
11	F3	Outdoor ambient temperature sensor is open/short circuited
12	F4	Outdoor condenser temperature sensor is open/short circuited
13	F5	Outdoor discharge temperature sensor is open/short circuited
14	C5	Jumper cap malfunction protection
15	EE	Loading EEPROM malfunction

Note: If there're other error codes, please contact qualified professionals for service.

When the unit is connected with the wired controller, the error code will be simultaneously shown on it.

(2). Instructions to the Error Indicating Lamps on the Panel of the Floor Ceiling Type Unit.



Fig. 31

States of the Indicating Lamps:

①. Indicating Lamp of "POWER":

The indicating lamp will shine when power on, while it will go out when power off.

②. Indicating Lamp of "COOL" :

The indicating lamp will shine when "COOL" is activated, while it will go out when "COOL" is deactivated.

③. Indicating Lamp of "HEAT":

The indicating lamp will shine when "HEAT" is activated, while it will go out when "HEAT" is deactivated.

④. Indicating Lamp of "TIMER":

Timer indicator on indoor unit will be on when timer ON is set under off status and timer OFF is set under on status.

NOTE:

(1) If the light of indoor unit is turned off, when operating the remote controller to send command, the display will be on for 3s and then off.

(2) When the wired controller is connected, the indoor unit display is invalid and the unit won't receive the remote control command.

8 Troubleshooting and Maintenance

8.1 Troubleshooting

If your air-conditioning unit suffers from abnormal operation or failure, please first check the following points before repair:

Table 9

Failure	Possible Reasons
The unit cannot be started.	<ul style="list-style-type: none"> ①. The power supply is not connected. ②. Electrical leakage of air-conditioning unit causes tripping of the leakage switch. ③. The operating keys are locked. ④. The control loop has failure.
The unit operates for a while and then stops.	<ul style="list-style-type: none"> ①. There is obstacle in front of the condenser. ②. The control loop is abnormal. ③. Cooling operation is selected when the outdoor ambient temperature is above 46°C (114.8°F).
Poor cooling effect.	<ul style="list-style-type: none"> ①. The air filter is dirty or blocked. ②. There is heat source or too many people inside the room. ③. The door or window is open. ④. There is obstacle at the air intake or outlet. ⑤. The set temperature is too high. ⑥. There is refrigerant leakage. ⑦. The performance of room temperature sensor becomes worse
Poor heating effect	<ul style="list-style-type: none"> ①. The air filter is dirty or blocked. ②. The door or window is not firmly closed. ③. The set room temperature is too low. ④. There is refrigerant leakage. ⑤. The outdoor ambient temperature is lower than -5°C (23°F). ⑥. Control loop is abnormal.



Note: After carrying out the check of the above items and taking relevant measures to solve the problems found but the air-conditioning unit still does not function well, please stop the operation of the unit immediately and contact the local service agency designated.

Only ask professional serviceman to check and repair the unit.

8.2 Routine Maintenance

 WARNING!	
①.	Do not turn off the unit and cut off the main power supply when cleaning the air conditioner, otherwise electric shock may happen.
②.	Do not make the air conditioner wet or electric shock may be lead; Ensure that the air conditioner will not be cleaned by water rinsing under any circumstance.
③.	Volatile liquid like thinner or gasoline would damage the appearance of air conditioner. (So, only soft dry cloth and wet cloth moistened by neutral cleaning fluid could be used to clean the surface panel of air conditioner.)

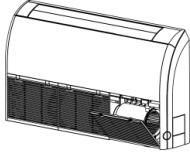
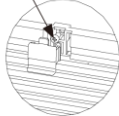
(1). Disassembly method of filter screen and electric box cover

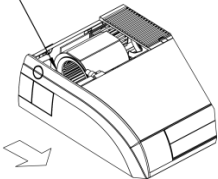
<p>1. Open the air inlet grille</p> <p>①. Firstly unfix two buckles on the grille as shown on the picture.</p> <p>②. Remove the screws under the buckles by a screwdriver and then open the inlet grille.</p>	
	<p>Remove the screw</p> 
<p>2. Clean the filter screen</p> <p>Clean the filter screen by a vacuum cleaner or wash it by flashing water. If the oil stain on the filter can not be removed or cleaned up, wash it by warm water meld with the detergent. Dry the filter in the shadow.</p> <p>Note: Never use hot water over 45°C (113°F) in case of color fading or turning yellow.</p> <p>Never dry it by fire so as to prevent the filter caught fire or deformation.</p>	
<p>3. Disassemble the left and right side board</p> <p>①. After the grille is removed, use a screwdriver to remove the screws shown on the picture.</p> <p>②. Push the side plate as per the arrowed direction and take it down.</p>	<p>Remove the screw</p> 
<p>4. Disassemble the right side board</p>	<p>Disassembly method of right side board Step 3</p>