



# User Manual for WiFi Module

For Controlling WiFi Compatible Ceiling-Mounted  
BLURIDGE Ductless Mini-Split HVAC Equipment

Applies to model WiFi Module # **WFCC**

Document Version July 2018

Effort has been made to insure compatibility of this device with standard home networking equipment and with iOS and Android operating systems. However, due to the variety of hardware and software found in home networks, compatibility is not assured with your particular network. Please read the manual carefully before installing or connecting your WFCC WiFi adapter. (It is recommended to save a copy of these instructions for future reference.)

# AVOID *FRUSTRATION* - READ THIS

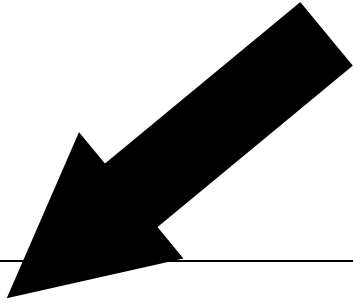

## WHOA!

**When setting up this device, you may think it is broken when it is not.** Why? Because if the power is turned on to the mini-split equipment either for the first time, or by powering it off then on again to resolve a network or other setup issue, the equipment and related software will not operate for a *minimum of 15 minutes*. This includes the setup process for the app also not working for at least 15 minutes. The reason is because this mini-split equipment (as with most air conditioners) has a delay timer that is intended to keep the equipment from quickly starting after stopping, which could damage the condenser. And so it has been designed to prevent power to the equipment and software for the duration of this delay period. If you attempt to setup or use the app during this delay period, it will not function properly. Understanding this then, **after the equipment is powered on, you must wait at least 15 minutes before operating the WiFi module or the app on your mobile device.**

## *Table of Contents*

1. Specifications
2. Compatibility
3. Download and Install the App
4. Install the WiFi Module
5. Getting connected
6. Using the App
7. Troubleshooting

## 1. Specifications

Model: WFCC (OSK102)

Standard: IEEE 802.11b/g/n

Antenna Type: External omnidirectional Antenna

Frequency: WIFI – 2.4G

Maximum Transmitted Power: 15 dBm Max

Operation Temperature: 32 Deg F ~ 133 Deg F

Operation Humidity: 10% - 85%

Power Input: DC 5V/300mA

## 2. Compatibility

The WFCC is designed for compatibility with devices using Android or iOS operating systems.

**Note:** Due to the frequency of OS updates, the app may not be compatible with the iOS and Android versions that are released after the manufacture of this device and software. It probably will be compatible, but it's uncertain what future OS updates may contain.



**Note:** The WFCC hardware device supports WPA-PSK/WPA2-PSK encryption and no encryption. WPA-PSK/WPA2-PSK encryption is recommended.

## 3. Download and Install the App

Search the App Store (iOS) or Google Play Store (Android) for **Nethome Plus**, download and install.

If you prefer, you can scan the appropriate QR code below using the camera (iOS) or QR code reader software (Android) to take you directly to the compatible app for your device.

Download and Install.

	
Nethome Plus for <b>Android</b>	Nethome Plus for <b>iOS</b>

**Note!** These QR codes are *only* to get Nethome Plus App onto your iOS or Android device. Please do not confuse these for the QR code on the WiFi adapter, used for setup later.

#### 4. Install the WFCC WiFi module

- Remove the protective cap of the WFCC WiFi module

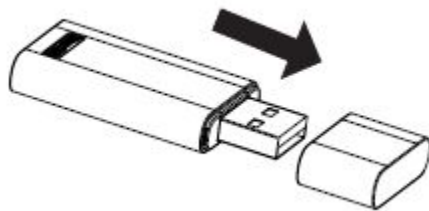

- The WFCC WiFi module kit comes with a SmartPort 'orb'. Release the cover of the 'orb' with a small screwdriver by inserting sequentially into each of the two slots as shown below, and releasing the locking tabs.

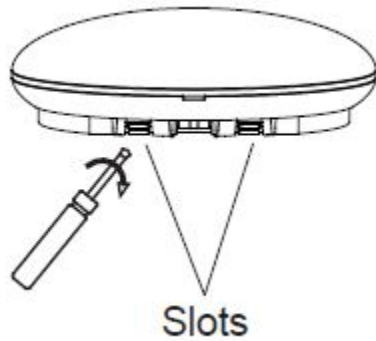

- Now insert the WFCC WiFi module into the receptacle under the lid as shown. You should feel it click securely into place.

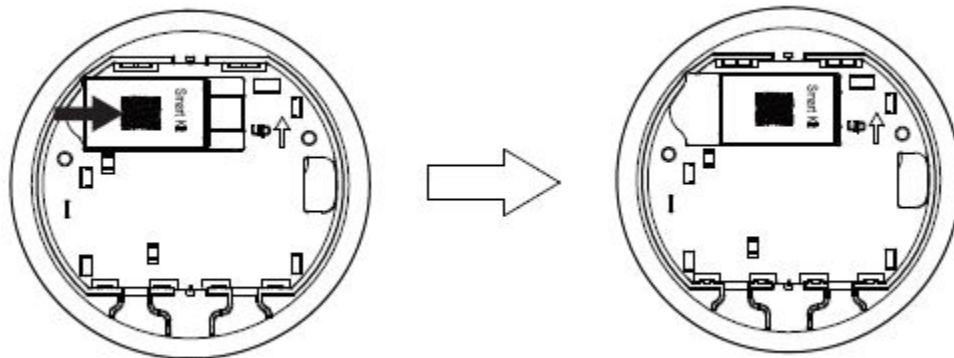

Note: The box includes a QR code sticker to assist in setup. We suggest you stick it inside the manual, or under the battery door of the remote.

## 5. Register

Make sure that WiFi is enabled on your Android or iOS device and that it is on your preferred (home) network.

- Locate Nethome Plus in your Apps and tap to launch.

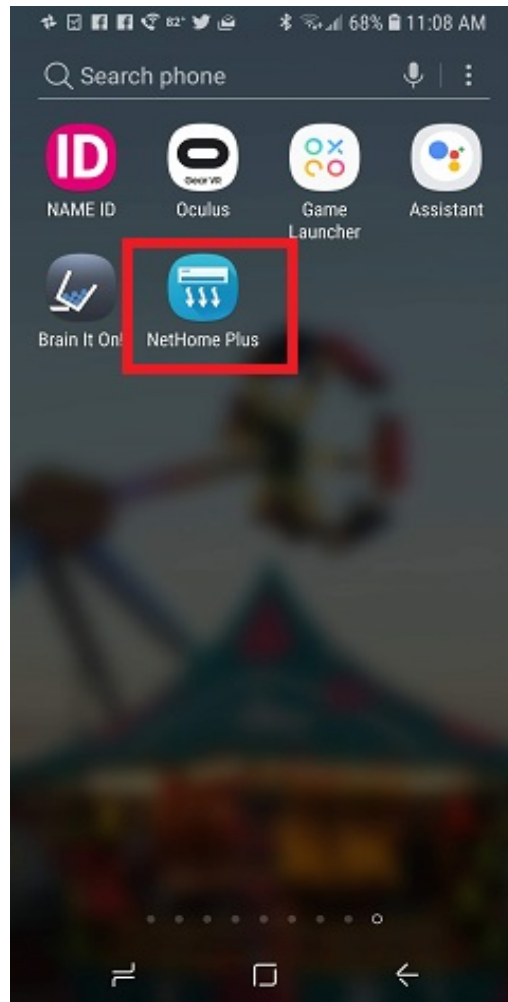

- Tap Create Account at the bottom of the screen.

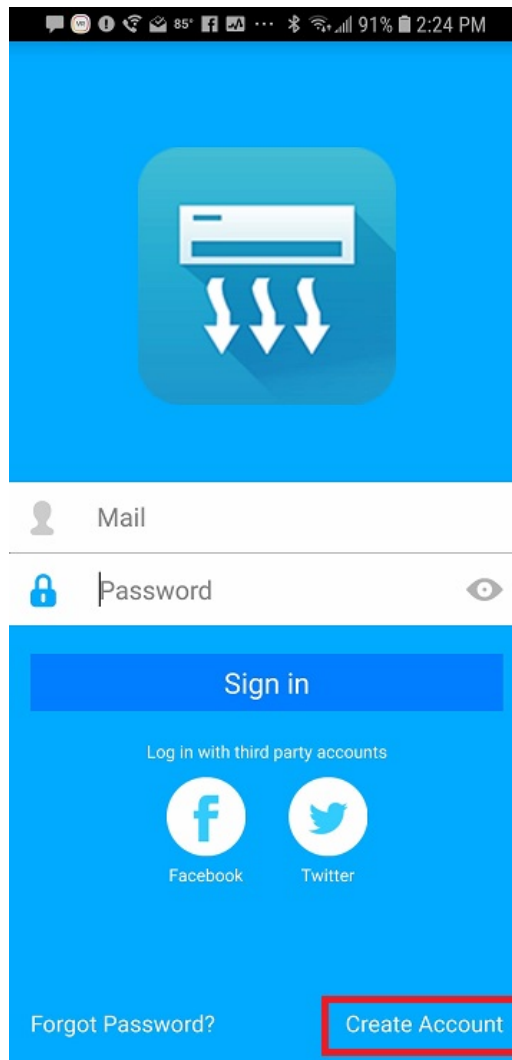

- Enter your email address and create a password. Then click Registration.

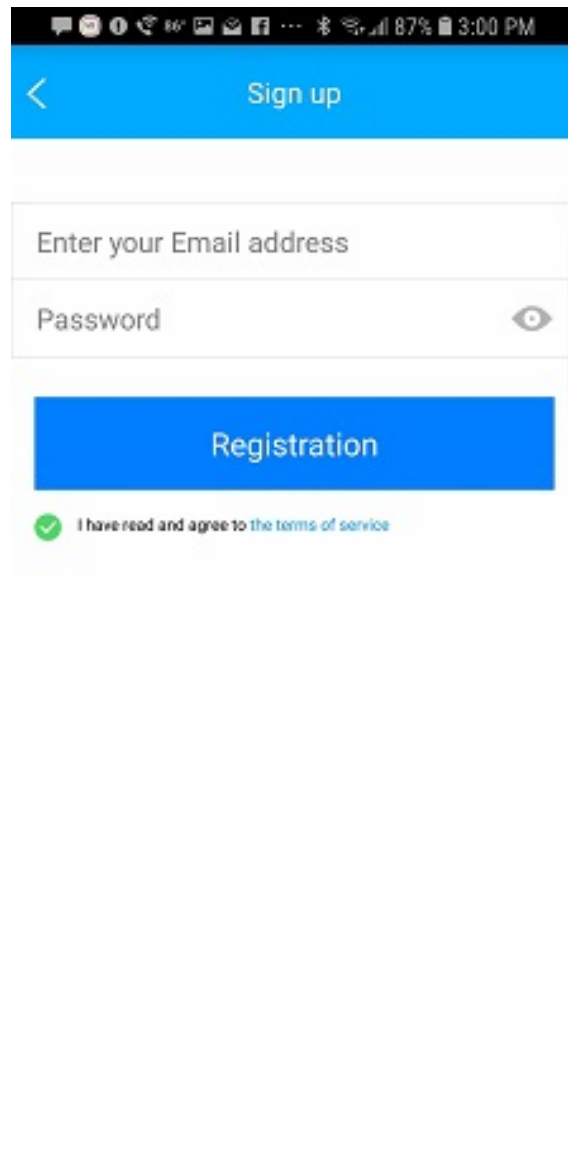

The image shows a mobile application registration screen. At the top, there is a blue header with a white back arrow on the left and the text "Sign up" in the center. Below the header are two input fields: "Enter your Email address" and "Password". The password field has a small eye icon on the right side. Below the input fields is a large blue button with the text "Registration" in white. At the bottom of the form, there is a green checkmark icon followed by the text "I have read and agree to the terms of service". The background of the form is white, and the entire screen is framed by a light gray border. The top of the screen shows a black status bar with various icons and the time "3:00 PM" and battery level "87%".

- Check your email. Click the link in your email to complete registration.



## 6. Getting Connected

- Start with the unit powered down. Using the AC remote, power up the unit and press the “LED” button 7 times until the wall unit displays “AP”.



Note: While in AP (programming) mode, the handheld remote control will not function. The unit automatically reverts to normal operation after 8 minutes, or after powering the unit off, then back on. The air handler displays the room temperature in normal operation mode.

- On your iOS or Android device, tap “+ Add Device”.

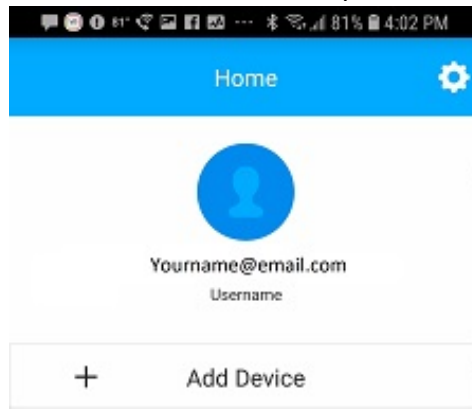

- On the next screen you have the option of using a QR code or configuring manually.
  - To use the QR code, tap 'Scan QR code' then hold the reader over the QR code in the paper manual that came with the WiFi adapter, or you can use the sticker sent with the WiFi adapter kit (see step 4.)

- To configure manually, tap AC from the 'home appliance type' menu, then follow the prompts.

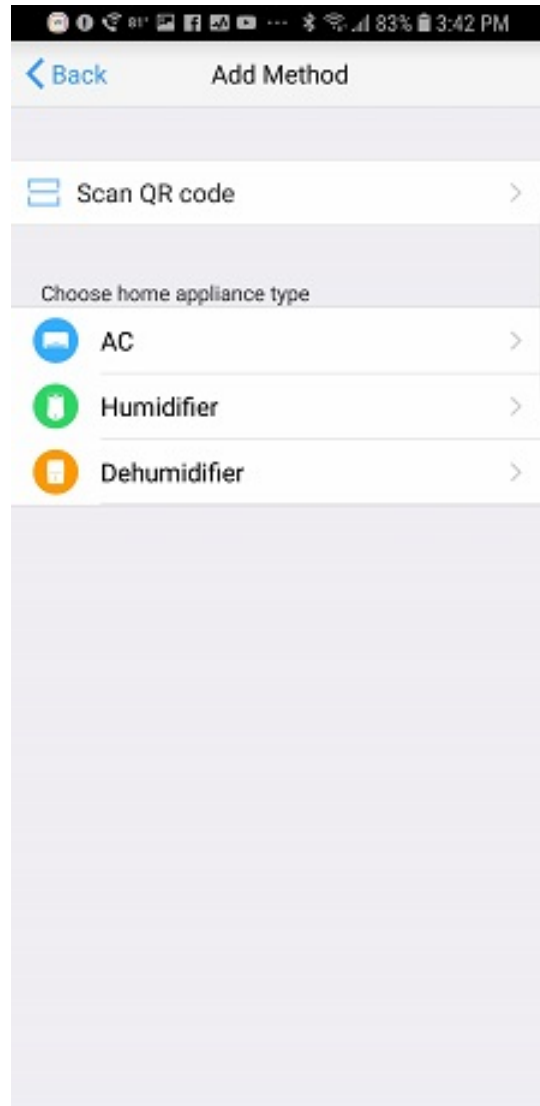

- The prompts will take you to your device's WiFi settings where you will see "net\_ac\_XXXX" as an available network. Tap "net\_ac\_XXXX" to (temporarily) join and enter password "12345678". NOTE: Joining this temporary network is part of the setup process and will not result in permanent changes.
- Next, your device will automatically revert to your home network, and you will be prompted to enter your usual home network password. You may see a dialog prompting you to do this step manually. If so, return to Settings/Connections/ WiFi, choose your home network and enter your usual home network password.

- Next you will see the configuration screen as shown below.

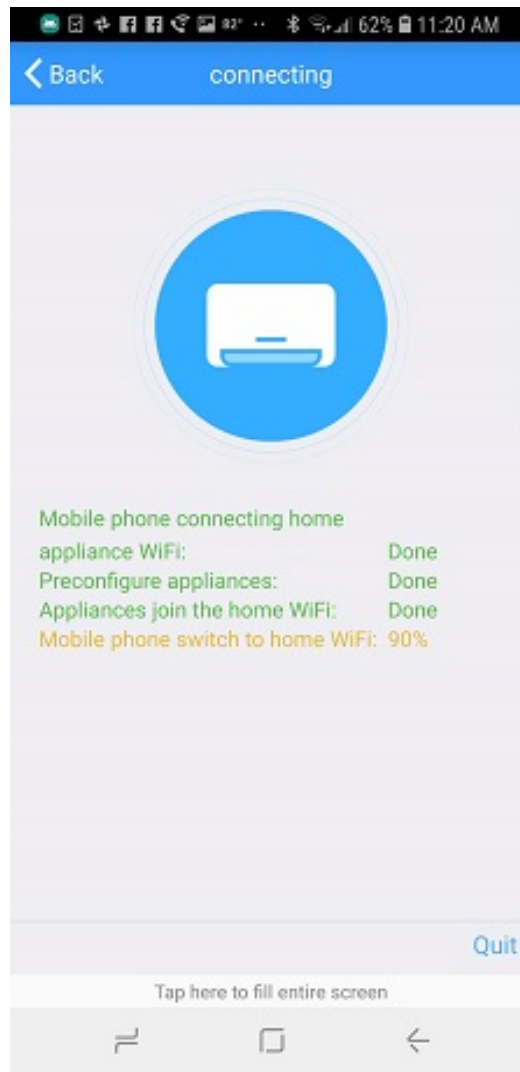

- Once the configuration process is complete, you will see a Success message, and you will see the device in the list above “+ Add Device”. NOTE: Try swiping down to refresh the list if it does not appear. If it still does not appear, power the mini-split equipment off and back on and wait 15-30 minutes.

## 7. Using the App

- Tap the device you wish to control from the home screen.

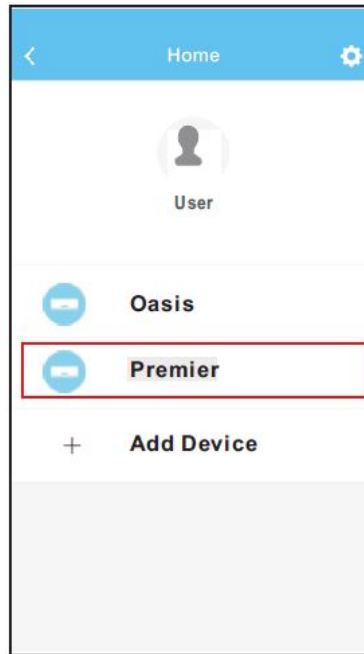

- From this screen, you can power the unit on and off, set operating mode (cool, dry, heat, etc.), control fan speed and toggle between Celsius and Fahrenheit. To change thermostat setting, drag your finger around the circle displaying temperature until you reach your desired setting.



Note: Some of the features found on the hand held wireless remote control may not be available on the app.

- You can program the system to turn itself on and off with the Timer function. Toggle start time, enter time settings, and select repeat as shown below. Repeat the process for stop times.

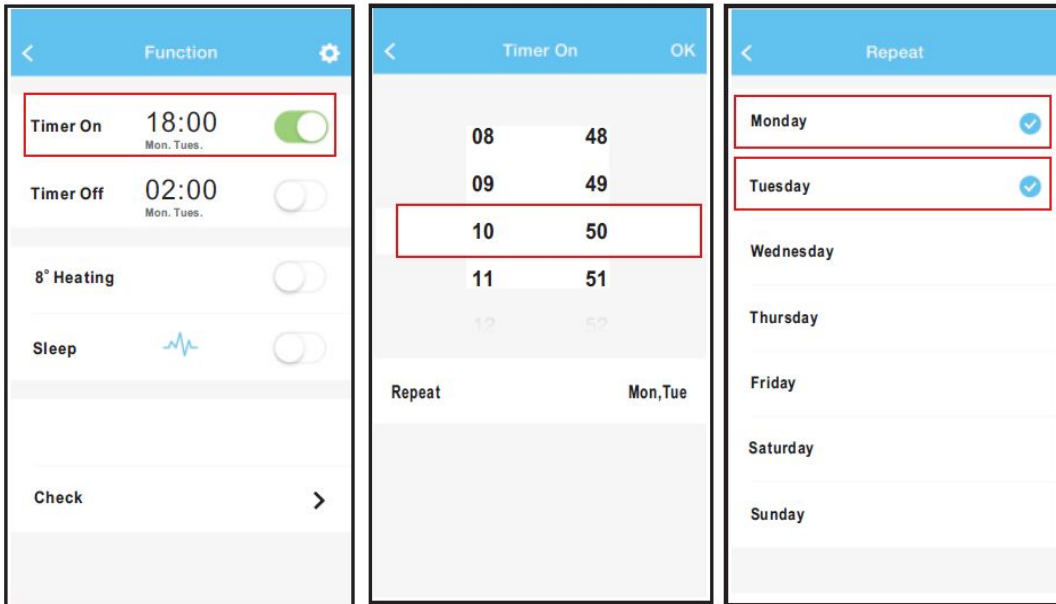

- You can program the system for overnight performance to create the ideal sleeping environment and energy use. Toggle the Sleep function and edit the temperature curve.

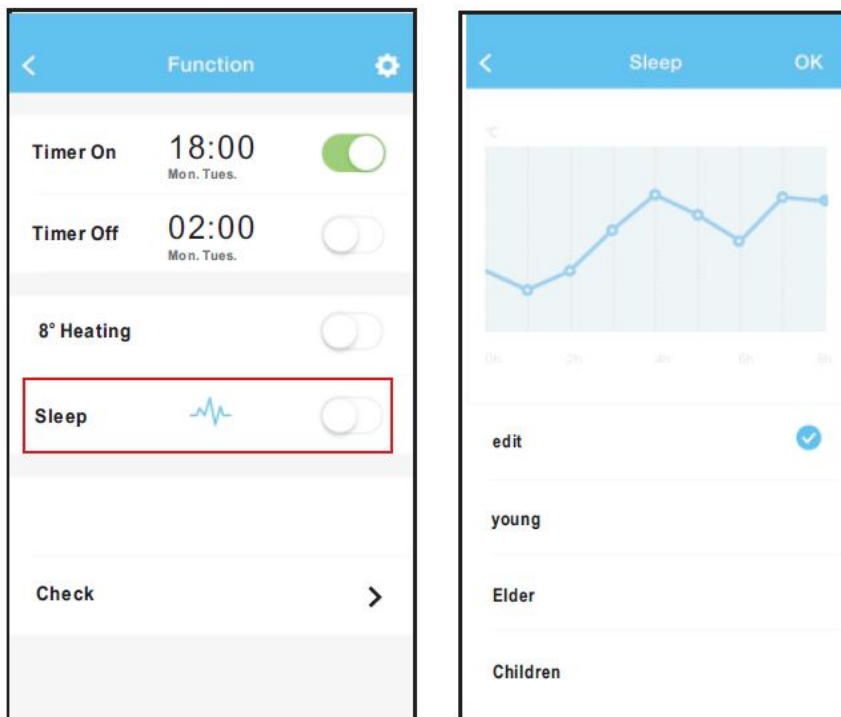

## 8. If you have trouble with setup

Once you have seen the success message, the system is set up. However, you may not see the AC in the device list on the Nethome Plus home page. If this happens, try these steps in order.

- Swipe downwards on the Nethome Plus home page list, where it says "+ Add Device". You should see the software refreshing the page. Try this a few times, and if nothing appears, wait 15- 30 minutes and try again.
- Power off the AC unit using the remote. Power the unit back up and wait 15- 30 minutes. The device should appear in the list. If not, try swiping down a few times.
- Power off the AC unit with the remote, then cut power to the AC at the breaker. Unplug power from your WiFi router and restart your Android or iOS device. Power everything back up and wait 15- 30 minutes. Try swiping down to refresh the list, and if no result repeat the entire installation process.

---

*Thank you for your purchase of a BLUERIDGE ductless mini-split system and WiFi app controller!*

*We hope this equipment and the app will provide you and yours with many years of comfortable enjoyment of your space.*

Kind Regards,

*The BLUERIDGE Team*

