

# GMS8, GHS8, GDS8 GAS-FIRED WARM AIR FURNACE SINGLE STAGE INSTALLATION INSTRUCTIONS

*Installer: Affix all manuals adjacent to the unit.*

(CATEGORY 1)

These furnaces comply with requirements embodied in the American National Standard / National Standard of Canada ANSI Z21.47-CSA-2.3 Gas Fired Central Furnaces.



**RECOGNIZE THIS SYMBOL AS A SAFETY PRECAUTION.**

## ATTENTION INSTALLING PERSONNEL

As a professional installer, you have an obligation to know the product better than the customer.  
This includes all safety precautions and related items.

Prior to actual installation, thoroughly familiarize yourself with this Instruction Manual.  
Pay special attention to all safety warnings. Often during installation or repair, it is possible to place yourself in a position which is more hazardous than when the unit is in operation.

Remember, it is **your** responsibility to install the product safely and to know it well enough to be able to instruct a customer in its safe use.

Safety is a matter of common sense...a matter of thinking before acting.  
Most dealers have a list of specific, good safety practices...follow them.

The precautions listed in this Installation Manual are intended as supplemental to existing practices.  
However, if there is a direct conflict between existing practices and the content of this manual, the precautions listed here take precedence.

\*NOTE: Please contact your distributor  
or our website for the applicable product data book  
referred to in this manual.

Goodman Manufacturing Company, L.P.  
2550 North Loop West, Suite 400, Houston, TX 77092  
[www.goodmanmfg.com](http://www.goodmanmfg.com)

## Table of Contents

<b>I. GENERAL INFORMATION</b> .....	4
<b>TO THE OWNER</b> .....	4
<b>TO THE INSTALLER</b> .....	4
<b>TRANSPORTATION DAMAGE</b> .....	4
<b>II. SAFETY</b> .....	4
<b>ELECTROSTATIC DISCHARGE (ESD) PRECAUTIONS</b> .....	5
<b>III. PRODUCT APPLICATION</b> .....	5
<b>IV. LOCATION REQUIREMENTS AND CONSIDERATIONS</b> .....	6
<b>GENERAL</b> .....	6
<b>CLEARANCES AND ACCESSIBILITY</b> .....	7
<b>HORIZONTAL INSTALLATION</b> .....	7
<b>FURNACE SUSPENSION</b> .....	7
<b>EXISTING FURNACE REMOVAL</b> .....	7
<b>THERMOSTAT LOCATION</b> .....	8
<b>V. COMBUSTION AND VENTILATION AIR REQUIREMENTS</b> .....	8
<b>VI. CATEGORY I VENTING (VERTICAL VENTING)</b> .....	10
<b>VII. EXTERIOR MASONRY CHIMNEYS -</b> .....	11
<b>CHECKLIST SUMMARY</b> .....	11
<b>CHECK 1 - PROPER CHIMNEY TERMINATION.</b> .....	12
<b>CHECK 2 - ANY SOLID OR LIQUID FUEL APPLIANCES VENTED INTO THIS CHIMNEY CHANNEL</b> .....	12
<b>CHECK 3 - CHIMNEY CROWN CONDITION.</b> .....	12
<b>CHECK 4 - DEBRIS IN CLEANOUT</b> .....	13
<b>CHECK 5 - LINER CONDITION.</b> .....	13
<b>CHECK 6 - DILUTION AIR.</b> .....	13
<b>CHECK 7 - COMPLETE THE INSTALLATION.</b> .....	13
<b>Fix 1 - LINER TERMINATION</b> .....	13
<b>Fix 2 -CHANGE VENTING ARRANGEMENTS</b> .....	14
<b>Fix 3 - REBUILD THE CROWN</b> .....	14
<b>Fix 4 - RELINING</b> .....	14
<b>VIII. ELECTRICAL CONNECTIONS</b> .....	14
<b>WIRING HARNESS</b> .....	15
<b>115 VOLT LINE CONNECTIONS</b> .....	15
<b>FOSSIL FUIEL APPLICATIONS</b> .....	15
<b>JUNCTION BOX RELOCATION</b> .....	15
<b>24 VOLT THERMOSTAT WIRING</b> .....	16
<b>SETTING THE HEAT ANTICIPATOR</b> .....	16
<b>24 VAC HUM</b> .....	16
<b>IX. GAS SUPPLY AND PIPING</b> .....	16
<b>GENERAL</b> .....	17
<b>HIGH ALTITUDE DERATE</b> .....	17
<b>ALTERNATE HIGH ALTITUDE DERATE</b> .....	17
<b>FIRING RATE</b> .....	17
<b>PROPANE GAS CONVERSION</b> .....	17
<b>GAS PIPING CONNECTIONS</b> .....	18
<b>GENERAL</b> .....	18
<b>UPFLOW INSTALLATIONS</b> .....	18
<b>COUNTERFLOW INSTALLATIONS</b> .....	19
<b>GAS PIPING CHECKS</b> .....	19
<b>PROPANE GAS TANKS AND PIPING</b> .....	19
<b>PROPANE GAS PIPING CHARTS</b> .....	19
<b>X. CIRCULATING AIR AND FILTERS</b> .....	20
<b>FILTERS - READ THIS SECTION BEFORE INSTALLING THE RETURN AIR DUCTWORK</b> .....	20
<b>UPRIGHT INSTALLATIONS</b> .....	20
<b>CIRCULATION AIR FILTERS</b> .....	20
<b>HORIZONTAL INSTALLATIONS</b> .....	20
<b>XI. SEQUENCE OF OPERATION</b> .....	21
<b>POWER UP</b> .....	21
<b>NORMAL HEATING SEQUENCE</b> .....	21
<b>NORMAL COOLING SEQUENCE</b> .....	21

## Table of Contents

FAN ONLY .....		21
<b>XII. START-UP PROCEDURE AND ADJUSTMENT .....</b>		<b>21</b>
FURNACE OPERATION .....		21
FURNACE START-UP .....		21
FURNACE SHUTDOWN .....		22
GAS SUPPLY PRESSURE MEASUREMENT .....		22
WHITE-RODGERS 36F22 GAS VALVE .....		22
WHITE-RODGERS 36G22 GAS VALVE .....		22
GAS MANIFOLD PRESSURE MEASUREMENT AND ADJUSTMENT .....		23
WHITE-RODGERS 36F22 GAS VALVE .....		23
WHITE-RODGERS 36G22 GAS VALVE .....		23
GAS INPUT RATE MEASUREMENT (NATURAL GAS ONLY) .....		23
TEMPERATURE RISE .....		24
CIRCULATOR BLOWER SPEED ADJUSTMENT .....		24
CIRCULATOR BLOWER FAN TIMING ADJUSTMENT .....		25
<b>XIII. OPERATIONAL CHECKS .....</b>		<b>25</b>
BURNER FLAME .....		25
AUXILIARY LIMIT CONTROL .....		25
<b>XIV. SAFETY CIRCUIT DESCRIPTION .....</b>		<b>26</b>
GENERAL .....		26
INTEGRATED CONTROL MODULE .....		26
PRIMARY LIMIT .....		26
AUXILIARY LIMIT .....		26
ROLLOUT LIMITS .....		26
PRESSURE SWITCHES .....		26
FLAME SENSOR .....		26
<b>XV. TROUBLESHOOTING .....</b>		<b>26</b>
ELECTROSTATIC DISCHARGE (ESD) PRECAUTIONS .....		26
DIAGNOSTIC CHART .....		26
RESETTING FROM LOCKOUT .....		26
<b>XVI. MAINTENANCE .....</b>		<b>26</b>
ANNUAL INSPECTION .....		26
FILTERS .....		27
FILTER MAINTENANCE .....		27
FILTER REMOVAL .....		27
UPRIGHT FILTER REMOVAL .....		27
INDUCED DRAFT AND CIRCULATOR BLOWER MOTORS .....		27
FLAME SENSOR (QUALIFIED SERVICER ONLY) .....		27
IGNITER (QUALIFIED SERVICER ONLY) .....		27
BURNERS .....		27
<b>XVII. BEFORE LEAVING AN INSTALLATION .....</b>		<b>28</b>
<b>XVIII. REPAIR AND REPLACEMENT PARTS .....</b>		<b>28</b>
TROUBLE SHOOTING CHARTS .....		29 & 30
WIRING DIAGRAM .....		31

**WARNING**

**GOODMAN WILL NOT BE RESPONSIBLE FOR ANY INJURY OR PROPERTY DAMAGE ARISING FROM IMPROPER SERVICE OR SERVICE PROCEDURES. IF YOU INSTALL OR PERFORM SERVICE ON THIS UNIT, YOU ASSUME RESPONSIBILITY FOR ANY PERSONAL INJURY OR PROPERTY DAMAGE WHICH MAY RESULT. MANY JURISDICTIONS REQUIRE A LICENSE TO INSTALL OR SERVICE HEATING AND AIR CONDITIONING EQUIPMENT.**

**WARNING**

**IF THE INFORMATION IN THESE INSTRUCTIONS IS NOT FOLLOWED EXACTLY, A FIRE OR EXPLOSION MAY RESULT CAUSING PROPERTY DAMAGE, PERSONAL INJURY OR LOSS OF LIFE.**

- DO NOT STORE OR USE GASOLINE OR OTHER FLAMMABLE VAPORS AND LIQUIDS IN THE VICINITY OF THIS OR ANY OTHER APPLIANCE.
- **WHAT TO DO IF YOU SMELL GAS:**
  - DO NOT TRY TO LIGHT ANY APPLIANCE.
  - DO NOT TOUCH ANY ELECTRICAL SWITCH; DO NOT USE ANY PHONE IN YOUR BUILDING.
  - IMMEDIATELY CALL YOUR GAS SUPPLIER FROM A NEIGHBOR'S PHONE. FOLLOW THE GAS SUPPLIER'S INSTRUCTIONS.
  - IF YOU CANNOT REACH YOUR GAS SUPPLIER, CALL THE FIRE DEPARTMENT.
- INSTALLATION AND SERVICE MUST BE PERFORMED BY A QUALIFIED INSTALLER, SERVICE AGENCY OR THE GAS SUPPLIER.

## I. GENERAL INFORMATION

### WARNING

SHOULD OVERHEATING OCCUR OR THE GAS SUPPLY FAIL TO SHUT OFF, TURN OFF THE MANUAL GAS SHUTOFF VALVE EXTERNAL TO THE FURNACE BEFORE TURNING OFF THE ELECTRICAL SUPPLY.

**DANGER**  
PELIGRO



**CARBON MONOXIDE POISONING HAZARD**

Special Warning for Installation of Furnace or Air Handling Units in Enclosed Areas such as Garages, Utility Rooms or Parking Areas

Carbon monoxide producing devices (such as an automobile, space heater, gas water heater, etc.) should not be operated in enclosed areas such as unventilated garages, utility rooms or parking areas because of the danger of carbon monoxide (CO) poisoning resulting from the exhaust emissions. If a furnace or air handler is installed in an enclosed area such as a garage, utility room or parking area and a carbon monoxide producing device is operated therein, there must be adequate, direct outside ventilation.

This ventilation is necessary to avoid the danger of CO poisoning which can occur if a carbon monoxide producing device continues to operate in the enclosed area. Carbon monoxide emissions can be (re)circulated throughout the structure if the furnace or air handler is operating in any mode.

CO can cause serious illness including permanent brain damage or death.

B10259-216

### WARNING

TO PREVENT PERSONAL INJURY OR DEATH DUE TO IMPROPER INSTALLATION, ADJUSTMENT, ALTERATION, SERVICE OR MAINTENANCE, REFER TO THIS MANUAL. FOR ADDITIONAL ASSISTANCE OR INFORMATION, CONSULT A QUALIFIED INSTALLER, SERVICE AGENCY OR THE GAS SUPPLIER.

### To The Owner

It is important that you fill out the owner's registration card and mail it today. This will assist us in contacting you should any service or warranty information change in the future. When filling in the registration card, be sure to include the model, manufacturing, and serial numbers, plus the installation date.

Your warranty certificate is also supplied with the unit. Read the warranty carefully and note what is covered. Keep the warranty certificate in a safe location for future reference.

If additional information or operating instructions are required, contact the dealer where the purchase was made.

#### Homeowner Notice:

If the residence is left unattended for an extended period of time (i.e., 4 hours or greater), have your heating system periodically checked to ensure proper operation. Potential circumstances beyond our control such as power outages, gas service interruptions, product installation, or component failures could result in heating system operational problems.

### To The Installer

Before installing this unit, please read this manual thoroughly to familiarize yourself with specific items which must be adhered to, including but not limited to: unit maximum external static pressure, gas pressures, BTU input rating, proper electrical connections, circulating air temperature rise, minimum or maximum CFM, and motor speed connections, and venting. These furnaces are designed for Category I venting only.

### WARNING

TO PREVENT POSSIBLE PERSONAL INJURY OR DEATH DUE TO ASPHYXIATION, THIS FURNACE MUST BE CATEGORY I VENTED. DO NOT VENT USING CATEGORY III VENTING. PROVISIONS MUST BE MADE FOR VENTING COMBUSTION PRODUCTS OUTDOORS THROUGH A PROPER VENTING SYSTEM. THE LENGTH OF FLUE PIPE COULD BE A LIMITING FACTOR IN LOCATING THE FURNACE.

### TRANSPORTATION DAMAGE

All units are securely packed in shipping containers tested according to International Safe Transit Association specifications. The carton must be checked upon arrival for external damage. If damage is found, a request for inspection by carrier's agent must be made in writing immediately.

The furnace must be carefully inspected on arrival for damage and bolts or screws which may have come loose in transit. In the event of damage the consignee should:

1. Make a notation on delivery receipt of any visible damage to shipment or container.
2. Notify carrier promptly and request an inspection.
3. With concealed damage, carrier must be notified as soon as possible - preferably within five days.
4. File the claim with the following support documents within a nine month statute of limitations.
  - Original or certified copy of the Bill of Lading, or indemnity bond.
  - Original paid freight bill or indemnity in lieu thereof.
  - Original or certified copy of the invoice, showing trade and other discounts or reductions.
  - Copy of the inspection report issued by carrier's representative at the time damage is reported to carrier.

The carrier is responsible for making prompt inspection of damage and for a thorough investigation of each claim. The distributor or manufacturer will not accept claims from dealers for transportation damage.

**Keep this literature in a safe place for future reference.**

## II. SAFETY

Adhere to the following warnings and cautions when installing, adjusting, altering, servicing, or operating the furnace.

### WARNING

THIS PRODUCT CONTAINS OR PRODUCES A CHEMICAL OR CHEMICALS WHICH MAY CAUSE SERIOUS ILLNESS OR DEATH AND WHICH ARE KNOWN TO THE STATE OF CALIFORNIA TO CAUSE CANCER, BIRTH DEFECTS OR OTHER REPRODUCTIVE HARM.



## WARNING

TO PREVENT POSSIBLE PROPERTY DAMAGE, PERSONAL INJURY OR DEATH DUE TO ELECTRICAL SHOCK, THE FURNACE MUST BE LOCATED TO PROTECT THE ELECTRICAL COMPONENTS FROM WATER.



## WARNING

HEATING UNIT SHOULD NOT BE UTILIZED WITHOUT REASONABLE, ROUTINE, INSPECTION, MAINTENANCE AND SUPERVISION. IF THE BUILDING IN WHICH ANY SUCH DEVICE IS LOCATED WILL BE VACANT, CARE SHOULD BE TAKEN THAT SUCH DEVICE IS ROUTINELY INSPECTED, MAINTAINED AND MONITORED. IN THE EVENT THAT THE BUILDING MAYBE EXPOSED TO FREEZING TEMPERATURES AND WILL BE VACANT, ALL WATER-BEARING PIPES SHOULD BE DRAINED, THE BUILDING SHOULD BE PROPERLY WINTERIZED, AND THE WATER SOURCE CLOSED. IN THE EVENT THAT THE BUILDING MAY BE EXPOSED TO FREEZING TEMPERATURES AND WILL BE VACANT, ANY HYDRONIC COIL UNITS SHOULD BE DRAINED AS WELL AND, IN SUCH CASE, ALTERNATIVE HEAT SOURCES SHOULD BE UTILIZED.

### ADDITIONAL SAFETY CONSIDERATIONS

- This furnace is approved for Category I Venting only.
- Provisions must be made for venting combustion products outdoors through a proper venting system. The length of flue pipe could be a limiting factor in locating the furnace.

### ELECTROSTATIC DISCHARGE (ESD) PRECAUTIONS

**NOTE:** Discharge body's static electricity before touching unit. An electrostatic discharge can adversely affect electrical components.

Use the following precautions during furnace installation and servicing to protect the integrated control module from damage. By putting the furnace, the control, and the person at the same electrostatic potential, these steps will help avoid exposing the integrated control module to electrostatic discharge. This procedure is applicable to both installed and non-installed (ungrounded) furnaces.

1. Disconnect all power to the furnace. Do not touch the integrated control module or any wire connected to the control prior to discharging your body's electrostatic charge to ground.
2. Firmly touch a clean, unpainted, metal surface of the furnaces near the control. Any tools held in a person's hand during grounding will be discharged.
3. Service integrated control module or connecting wiring following the discharge process in step 2. Use caution not to recharge your body with static electricity; (i.e., do not move or shuffle your feet, do not touch ungrounded objects, etc.). If you come in contact with an ungrounded object, repeat step 2 before touching control or wires.
4. Discharge your body to ground before removing a new control from its container. Follow steps 1 through 3 if installing the control on a furnace. Return any old or new controls to their containers before touching any ungrounded object.

### III. PRODUCT APPLICATION

This furnace is primarily designed for residential home-heating applications. It is NOT designed or certified for use in mobile homes, trailers or recreational vehicles. Neither is it designed or certified for outdoor applications. The furnace **must** be installed indoors (i.e., attic space, crawl space, or garage area provided the garage area is enclosed with an operating door).

This furnace can be used in the following non-industrial commercial applications:

**Schools, Office buildings, Churches, Retail stores,  
Nursing homes, Hotels/motels, Common or office areas**

In such applications, the furnace must be installed with the following stipulations:

- It must be installed per the installation instructions provided and per local and national codes.
- It must be installed indoors in a building constructed on site.
- It must be part of a ducted system and not used in a free air delivery application.
- It must not be used as a "make-up" air unit.
- All other warranty exclusions and restrictions apply.

This furnace may be used as a construction site heater **ONLY** if the following conditions are met:

- The vent system is permanently installed per these installation instructions.
  - A room thermostat is used to control the furnace. Fixed jumpers that provide continuous heating CANNOT be used.
  - Return air ducts are provided and sealed to the furnace.
  - A return air temperature range between 60°F (16°C) and 80°F (27°C) is maintained.
  - Air filters are installed in the system and maintained during construction, replaced as appropriate during construction, and upon completion of construction are replaced.
  - The input rate and temperature rise are set per the furnace rating plate.
  - 100% outside air is provided for combustion air requirements during construction. Temporary ducting can be used.
- NOTE:** Do not connect the temporary duct directly to the furnace. The duct must be sized according to the instructions under *Section V, Combustion and Ventilation Air Requirements, Section 5.3.3.*
- The furnace heat exchanger, components, duct system, air filters and evaporator coils are thoroughly cleaned following final construction clean up.
  - All furnace operating conditions (including ignition, input rate, temperature rise and venting) are verified according to these installation instructions.

**NOTE:** The Commonwealth of Massachusetts requires that the following additional requirements must also be met:

- Gas furnaces must be installed by a licensed plumber or gas fitter.
- A T-handle gas cock must be used.
- If the unit is to be installed in an attic, the passageway to and the service area around the unit must have flooring.

To ensure proper installation and operation, thoroughly read this manual for specifics pertaining to the installation and application of this product.



## WARNING

POSSIBLE PROPERTY DAMAGE, PERSONAL INJURY OR DEATH DUE TO FIRE, EXPLOSION, SMOKE, SOOT, CONDENSTAION, ELECTRICAL SHOCK OR CARBON MONOXIDE MAY RESULT FROM IMPROPER INSTALLATION, REPAIR, OPERATION, OR MAINTENANCE OF THIS PRODUCT.



## WARNING

TO PREVENT PROPERTY DAMAGE, PERSONAL INJURY OR DEATH DUE TO FIRE, DO NOT INSTALL THIS FURNACE IN A MOBILE HOME, TRAILER, OR RECREATIONAL VEHICLE.

To ensure proper furnace operation, install, operate and maintain the furnace in accordance with these installation and operation instructions, all local building codes and ordinances. In their absence, follow the latest edition of the National Fuel Gas Code (NFPA 54/ANSI Z223.1), and/or CAN/CSA B149 Installation Codes, local plumbing or waste water codes, and other applicable codes.

A copy of the National Fuel Gas Code (NFPA 54/ANSI Z223.1) can be obtained from any of the following:

### American National Standards Institute

1430 Broadway  
New York, NY 10018

### National Fire Protection Association

1 Batterymarch Park  
Quincy, MA 02269

### CSA International

8501 East Pleasant Valley  
Cleveland, OH 44131

A copy of the CAN/CSA B149 Installation Codes can also be obtained from:

### CSA International

178 Rexdale Boulevard  
Etobicoke, Ontario, Canada M9W 1R3

The rated heating capacity of the furnace should be greater than or equal to the total heat loss of the area to be heated. The total heat loss should be calculated by an approved method or in accordance with "ASHRAE Guide" or "Manual J-Load Calculations" published by the Air Conditioning Contractors of America.

In the USA, this furnace MUST be installed in accordance with the latest edition of the ANSI Z223.1 booklet entitled "National Fuel Gas Code" (NFPA 54), and the requirements or codes of the local utility or other authority having jurisdiction. In Canada, this furnace must be installed in accordance with the current CAN/CSA-B149.1 & 2 Gas Installation Codes, local plumbing or waste water codes and other applicable codes. Additional helpful publications available from the NFPA are, NFPA 90A - Installation of Air Conditioning and Ventilating System and NFPA 90B - Warm Air Heating and Air Conditioning System.

All venting shall be in accordance with PART 7, Venting of Equipment, of the National Fuel Gas Code, ANSI Z223.1, or applicable local building and/or air conditioning codes. These publications are available from:

### National Fire Protection Association, Inc.

Batterymarch Park, Quincy, MA 02269

The G\*S8X furnaces meet the California NOx emission standards and California seasonal efficiency standards. ANNUAL inspections of the furnace and its vent system is strongly recommended.

## IV. LOCATION REQUIREMENTS AND CONSIDERATIONS

### GENERAL

Model type determines which installation procedures must be used. For GMS and GHS models, you must follow instructions for Horizontal Left, Horizontal Right or Upflow installations only. GMS and GHS models are not approved for Downflow installations.

For GDS models, you must follow instructions for Counterflow/Downflow installation only. GDS models are not approved for Horizontal or Upflow installations.



## WARNING

POSSIBLE PROPERTY DAMAGE, PERSONAL INJURY OR DEATH DUE TO FIRE, EXPLOSION, SMOKE, SOOT, CONDENSATION, ELECTRICAL SHOCK OR CARBON MONOXIDE MAY RESULT FROM IMPROPER INSTALLATION, REPAIR, OPERATION, OR MAINTENANCE OF THIS PRODUCT.



## WARNING

TO PREVENT POSSIBLE EQUIPMENT DAMAGE, PROPERTY DAMAGE, PERSONAL INJURY OR DEATH, THE FOLLOWING BULLET POINTS MUST BE OBSERVED WHEN INSTALLING THE UNIT.

Follow the instructions listed below when selecting a furnace location. Refer also to the guidelines provided in *Section V, Combustion and Ventilation Air Requirements*.

- Centrally locate the furnace with respect to the proposed or existing air distribution system.
- Ensure the temperature of the return air entering the furnace is between 55°F and 100°F when the furnace is heating.
- Provisions must be made for venting combustion products outdoors through a proper venting system. The length of flue pipe could be a limiting factor in locating the furnace.
- Ensure adequate combustion air is available for the furnace. Improper or insufficient combustion air can expose building occupants to gas combustion products that could include carbon monoxide. Refer to *Section V, Combustion and Ventilation Air Requirements*.
- The furnace must be level. If the furnace is to be set on a floor that may become wet or damp at times, the furnace should be supported above the floor on a concrete base sized approximately 1-1/2" larger than the base of the furnace.
- Ensure upflow or horizontal furnaces are not installed directly on carpeting, or any other combustible material. The only combustible material allowed is wood.
- Exposure to contaminated combustion air will result in safety and performance-related problems. Do not install the furnace where the combustion air is exposed to the following substances:
  - chlorinated waxes or cleaners
  - chlorine-based swimming pool chemicals
  - water softening chemicals
  - deicing salts or chemicals
  - carbon tetrachloride
  - halogen type refrigerants
  - cleaning solutions (such as perchloroethylene)
  - printing inks
  - paint removers
  - varnishes
  - hydrochloric acid
  - cements and glues
  - antistatic fabric softeners for clothes dryers
  - and masonry acid washing materials
- If the furnace is used in connection with a cooling unit, install the furnace upstream or in parallel with the cooling unit coil. Premature heat exchanger failure will result if the cooling unit coil is placed ahead of the furnace.
- If the furnace is installed in a residential garage, position the furnace so that the burners and ignition source are

located not less than 18 inches (457 mm) above the floor. Protect the furnace from physical damage by vehicles.

- If the furnace is installed horizontally, the furnace access doors must be vertical so that the burners fire horizontally into the heat exchanger. Do not install the unit with the access doors on the “up/top” or “down/bottom” side of the furnace.
- Do not connect this furnace to a chimney flue that serves a separate appliance designed to burn solid fuel.
- On Counterflow Installations, the air conditioning coil must be downstream from the heat exchanger of the furnace.
- *Counterflow Installation over a noncombustible floor.* Before setting the furnace over the plenum opening, ensure the surface around the opening is smooth and level. A tight seal should be made between the furnace base and floor by using a silicone rubber caulking compound or cement grout.
- *Counterflow Installation over a combustible floor.* If installation over a combustible floor becomes necessary, use an accessory subbase (see Product Data Book applicable to your model for details). A special accessory subbase must be used for upright counterflow unit installations over any combustible material including wood. Refer to subbase instructions for installation details. Follow the instructions with the subbase for proper installation. Do not install the furnace directly on carpeting, tile, or other combustible material other than wood flooring. (Note: The subbase will not be required if an air conditioning coil is installed between the supply air opening on the furnace and the floor.)

VENT		SIDES	FRONT	BACK	TOP (PLENUM)
B1-VENT	SINGLE				
1"	6"	1"	3"	0"	1"

Top clearance for horizontal configuration - 1"

### HORIZONTAL INSTALLATION

Line contact to framing is permitted when installed in the horizontal configuration. Line contact is defined as the portion of the cabinet that is formed by the intersection of the top and side. ACCESSIBILITY CLEARANCE, WHERE GREATER, SHOULD TAKE PRECEDENCE OVER MINIMUM FIRE PROTECTION CLEARANCE. A gas-fired furnace for installation in a residential garage must be installed so that the ignition source and burners are located not less than eighteen inches (18") above the floor and is protected or located to prevent physical damage by vehicles. A gas furnace must not be installed directly on carpeting, tile, or other combustible materials other than wood flooring.

### FURNACE SUSPENSION

If suspending the furnace from rafters or joist, use 3/8" threaded rod and 2"x2"x3/8" angle iron as shown below. The length of rod will depend on the application and the clearances necessary.

Vent Pipe Clearance to Combustibles- 6" using Single Wall Connector or 1" using B-1 vent.

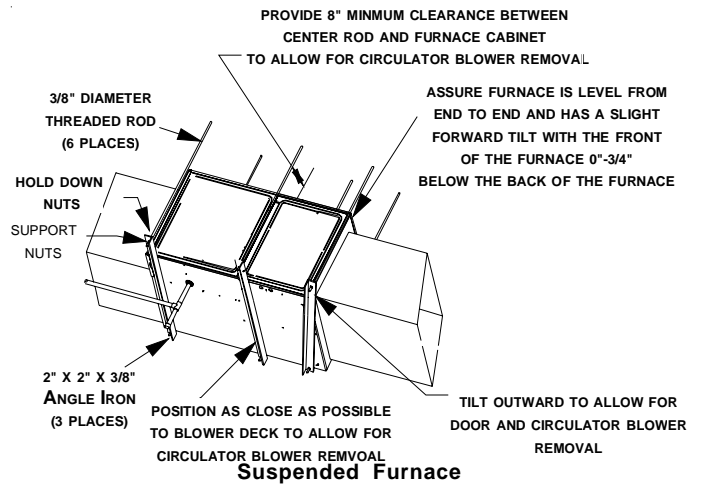
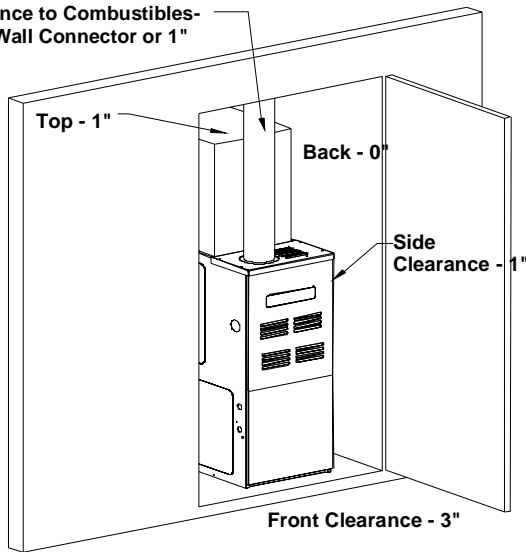

### EXISTING FURNACE REMOVAL

**NOTE:** When an existing furnace is removed from a venting system serving other appliances, the venting system may be too large to properly vent the remaining attached appliances.

The following vent testing procedure is reproduced from the **American National Standard/National Standard of Canada for Gas-Fired Central Furnaces ANSI Z21.47-Latest Edition, CSA-2.3-Latest Edition Section 1.23.1**. The following steps shall be followed with each appliance connected to the venting system placed in operation, while any other appliances connected to the venting system are not in operation:

- Adequate combustion/ventilation air must be supplied to the closet.
- Furnace must be **completely** sealed to floor or base. Combustion/ ventilation air supply pipes must terminate 12" from top of closet and 12" from floor of closet. DO NOT remove solid base plate for side return.
- Return air ducts must be **completely** sealed to the furnace and terminate outside the enclosure surfaces.

- a. Seal any unused openings in the venting system;
- b. Inspect the venting system for proper size and horizontal pitch, as required by the National Fuel Gas Code, ANSI Z223.1 or the CAN/CSA B149 Installation Codes and these instructions. Determine that there is no blockage or restriction, leakage, corrosion and other deficiencies which could cause an unsafe condition;
- c. In so far as practical, close all building doors and windows and all doors between the space in which the appliance(s) connected to the venting system are located and other spaces of the building. Turn on clothes dryers and any

### CLEARANCES AND ACCESSIBILITY

Unobstructed front clearance of 24" for servicing is recommended.

appliance not connected to the venting system. Turn on any exhaust fans, such as range hoods and bathroom exhausts, so they shall operate at maximum speed. Do not operate a summer exhaust fan. Close fireplace dampers;

- d. Follow the lighting instructions. Place the appliance being inspected into operation. Adjust thermostat so appliance shall operate continuously;
- e. Test for draft hood equipped appliance spillage at the draft hood relief opening after 5 minutes of main burner operation. Use the flame of a match or candle;
- f. After it has been determined that each appliance connected to the venting system properly vents when tested as outlined above, return doors, windows, exhaust fans, fireplace dampers and any other gas burning appliance to their previous conditions of use;
- g. If improper venting is observed during any of the above tests, the common venting system must be corrected.

Corrections must be in accordance with the latest edition of the National Fuel Gas Code NFPA 54/ANSI Z223.1 and/or CAN/CSA B149 Installation Codes.

If resizing is required on any portion of the venting system, use the appropriate table in Appendix G in the latest edition of the National Fuel Gas Code ANSI Z223.1 and/or CAN/CSA B149 Installation Codes.

### THERMOSTAT LOCATION

In an area having good air circulation, locate the thermostat about five feet high on a vibration-free inside wall. Do not install the thermostat where it may be influenced by any of the following:

- Drafts, or dead spots behind doors, in corners, or under cabinets.
- Hot or cold air from registers.
- Radiant heat from the sun.
- Light fixtures or other appliances.
- Radiant heat from a fireplace.
- Concealed hot or cold water pipes, or chimneys.
- Unconditioned areas behind the thermostat, such as an outside wall.

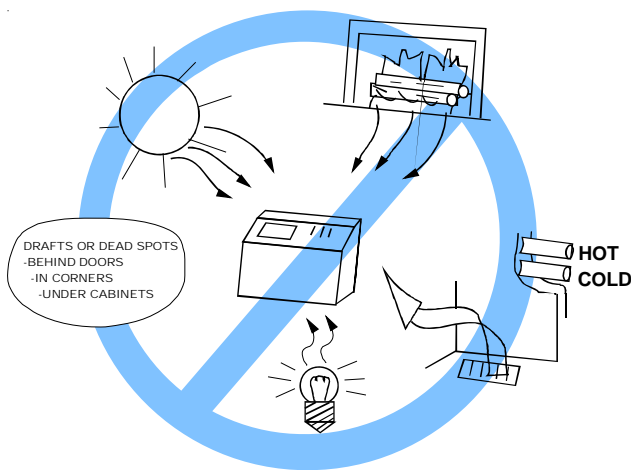

### Thermostat Influences

Consult the instructions packaged with the thermostat for mounting instructions and further precautions.

## V. COMBUSTION AND VENTILATION AIR REQUIREMENTS



**WARNING**  
 TO AVOID PROPERTY DAMAGE, PERSONAL INJURY OR DEATH, SUFFICIENT FRESH AIR FOR PROPER COMBUSTION AND VENTILATION OF FLUE GASES MUST BE SUPPLIED. MOST HOMES REQUIRE OUTSIDE AIR BE SUPPLIED INTO THE FURNACE AREA.

Improved construction and additional insulation in buildings have reduced heat loss by reducing air infiltration and escape around doors and windows. These changes have helped in reducing heating/cooling costs but have created a problem supplying combustion and ventilation air for gas fired and other fuel burning appliances. Appliances that pull air out of the house (clothes dryers, exhaust fans, fireplaces, etc.) increase the problem by starving appliances for air.

House depressurization can cause back drafting or improper combustion of gas-fired appliances, thereby exposing building occupants to gas combustion products that could include carbon monoxide.

If this furnace is to be installed in the same space with other gas appliances, such as a water heater, ensure there is an adequate supply of combustion and ventilation air for the other appliances. Refer to the latest edition of the National Fuel Gas Code NFPA 54/ANSI Z223.1 (Section 5.3), or CAN/CSA B149 Installation Codes (Sections 7.2, 7.3, or 7.4), or applicable provisions of the local building codes for determining the combustion air requirements for the appliances.

*This furnace must use indoor air for combustion. It cannot be installed as a direct vent (i.e., sealed combustion) furnace.*

Most homes will require outside air be supplied to the furnace area by means of ventilation grilles or ducts connecting directly to the outdoors or spaces open to the outdoors such as attics or crawl spaces.

The following information on air for combustion and ventilation is reproduced from the **National Fuel Gas Code NFPA 54/ANSI Z223.1 Section 5.3.**

### 5.3.1 General:

- (a) The provisions of 5.3 apply to gas utilization equipment installed in buildings and which require air for combustion, ventilation and dilution of flue gases from within the building. They do not apply to (1) direct vent equipment which is constructed and installed so that all air for combustion is obtained from the outside atmosphere and all flue gases are discharged to the outside atmosphere, or (2) enclosed furnaces which incorporate an integral total enclosure and use only outside air for combustion and dilution of flue gases.
- (b) Equipment shall be installed in a location in which the facilities for ventilation permit satisfactory combustion of gas, proper venting and the maintenance of ambient temperature at safe limits under normal conditions of use. Equipment shall be located so as not to interfere with proper circulation of air. When normal infiltration does not provide the necessary air, outside air shall be introduced.
- (c) In addition to air needed for combustion, process air shall be provided as required for: cooling of equipment or material, controlling dew point, heating, drying, oxidation or dilution, safety exhaust, odor control, and air for compressors.

- (d) In addition to air needed for combustion, air shall be supplied for ventilation, including all air required for comfort and proper working conditions for personnel.
- (e) While all forms of building construction cannot be covered in detail, air for combustion, ventilation and dilution of flue gases for gas utilization equipment vented by natural draft normally may be obtained by application of one of the methods covered in 5.3.3 and 5.3.4.
- (f) Air requirements for the operation of exhaust fans, kitchen ventilation systems, clothes dryers, and fireplaces shall be considered in determining the adequacy of a space to provide combustion air requirements.

**5.3.2 Equipment Located in Unconfined Spaces:**

In unconfined spaces (see definition below) in buildings, infiltration may be adequate to provide air for combustion ventilation and dilution of flue gases. However, in buildings of tight construction (for example, weather stripping, heavily insulated, caulked, vapor barrier, etc.), additional air may need to be provided using the methods described in 5.3.3-b or 5.3.4.

**Space, Unconfined.**

For purposes of this Code, a space whose volume is not less than 50 cubic feet per 1,000 BTU per hour of the aggregate input rating of all appliances installed in that space. Rooms communicating directly with the space in which the appliances are installed through openings not furnished with doors, are considered a part of the unconfined space.

**5.3.3 Equipment Located in Confined Spaces:**

- (a) *All Air from Inside the Building:* The confined space shall be provided with two permanent openings communicating directly with an additional room(s) of sufficient volume so that the combined volume of all spaces meets the criteria for an unconfined space. The total input of all gas utilization equipment installed in the combined space shall be considered in making this determination. Each opening shall have a minimum free area of 1 square inch per 1,000 BTU per hour of the total input rating of all gas utilization equipment in the confined space, but not less than 100 square inches. One opening shall be within 12 inches of the top and one within 12 inches of the bottom of the enclosure.

**NOTE: Each opening must have a free area of not less than one square inch per 1000 BTU of the total input rating of all equipment in the enclosure, but not less than 100 square inches.**

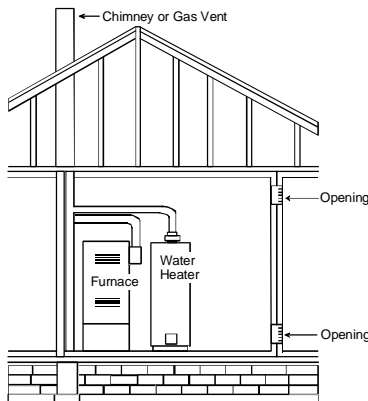

**Equipment Located in Confined Spaces; All Air from Inside Building. See 5.3.3-a.**

- (b) *All Air from Outdoors:* The confined space shall be provided with two permanent openings, one commencing within 12 inches of the top and one commencing within 12 inches of

the bottom of the enclosure. The openings shall communicate directly, or by ducts, with the outdoors or spaces (crawl or attic) that freely communicate with the outdoors.

1. When directly communicating with the outdoors, each opening shall have a minimum free area of 1 square inch per 4,000 BTU per hour of total input rating of all equipment in the enclosure.

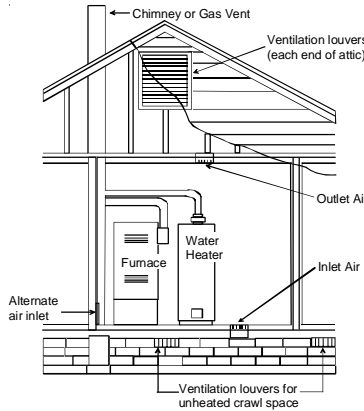

**NOTE: The inlet and outlet air openings must each have a free area of not less than one square inch per 4000 BTU of the total input rating of all equipment in the enclosure.**

**Equipment Located in Confined Spaces; All Air from Outdoors—Inlet Air from Ventilated Crawl Space and Outlet Air to Ventilated Attic. See 5.3.3-b**

2. When communicating with the outdoors through vertical ducts, each opening shall have a minimum free area of 1 square inch per 4,000 BTU per hour of total input rating of all equipment in the enclosure.

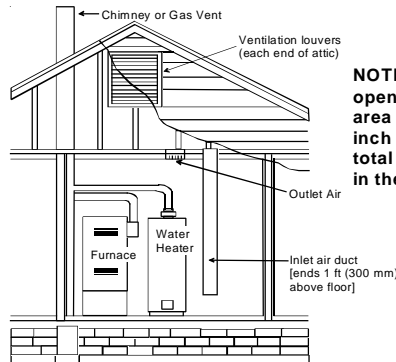

**NOTE: The inlet and outlet air openings must each have a free area of not less than one square inch per 4000 BTU of the total input rating of all equipment in the enclosure.**

**Equipment Located in Confined Spaces; All Air from Outdoors Through Ventilated Attic. See 5.3.3-b.**

3. When communicating with the outdoors through horizontal ducts, each opening shall have a minimum free area of 1 square inch per 2,000 BTU per hour of total input rating of all equipment in the enclosure.

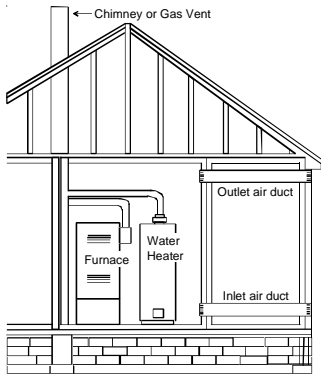

**NOTE:** The air duct openings must have a free area of not less than one square inch per 2000 BTU of the total input rating of all equipment in the enclosure\*.

**Equipment Located in Confined Spaces; All Air from Outdoors. See 5.3.3-b.**

\*If the appliance room is located against an outside wall and the air openings communicate directly with the outdoors, each opening shall have a free area of not less than one square inch per 4,000 BTU per hour of the total input rating of all appliances in the enclosure.

- When ducts are used, they shall be of the same cross-sectional area as the free area of the openings to which they connect. The minimum dimension of rectangular air ducts shall not be less than 3 inches.

**NOTE:** The single opening must have a free area of not less than one square inch per 3000 BTU of the total input rating of all equipment in the enclosure, but not less than the sum of the areas of all vent connectors in the confined space.

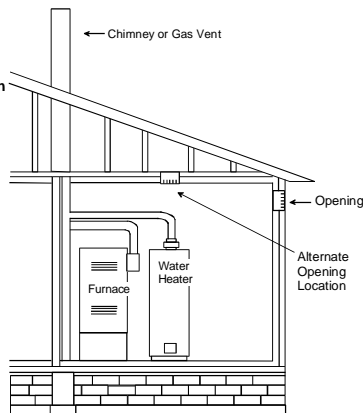

**Equipment Located in Confined Spaces; All Air from Outdoors - Single Air Opening. See 5.3.3-b.**

- One permanent opening may be permitted, provided the equipment has clearances of at least 1" from the sides and back and 6" from the front. The opening shall communicate directly with the outdoors and must be located within 12" of the top of the enclosure. The minimum free area of the opening shall be 1 square inch per 3,000 BTU per hour of total input rating of all equipment in the enclosure. The minimum free area shall not be less than the sum of the areas of all vent connectors in the confined space.

#### 5.3.4 Specially Engineered Installations:

The requirements of 5.3.3 shall not necessarily govern when special engineering, approved by the authority having jurisdiction, provides an adequate supply of air for combustion, ventilation, and dilution of flue gases.

#### 5.3.5 Louvers and Grilles:

In calculating free area in 5.3.3, consideration shall be given to the blocking effect of louvers, grilles or screens protecting openings. Screens used shall not be smaller than 1/4 inch mesh. If the area through a design of louver or grille is known, it should be used in calculating the size of opening required

to provide the free area specified. If the design and free area is not known, it may be assumed that wood louvers will have 20-25 percent free area and metal louvers and grilles will have 60-75 percent free area. Louvers and grilles shall be fixed in the open position or interlocked with the equipment so that they are opened automatically during equipment operation.

#### 5.3.6 Special Conditions Created by Mechanical Exhausting or Fireplaces:

Operation of exhaust fans, ventilation systems, clothes dryers, or fireplaces may create conditions requiring special attention to avoid unsatisfactory operation of installed gas utilization equipment.

### VI. CATEGORY I VENTING (VERTICAL VENTING)

**⚠ WARNING**

**TO PREVENT POSSIBLE PERSONAL INJURY OR DEATH DUE TO ASPHYXIATION, THIS FURNACE MUST BE CATEGORY I VENTED. DO NOT VENT USING CATEGORY III VENTING.**

Category I Venting is venting at a non-positive pressure. A furnace vented as Category I is considered a fan-assisted appliance and the vent system does not have to be "gas tight." **NOTE:** Single stage gas furnaces with induced draft blowers draw products of combustion through a heat exchanger allowing, in some instances, common venting with natural draft appliances (i.e. water heaters). All installations must be vented in accordance with National Fuel Gas Code NFPA 54/ANSI Z223.1 - latest edition. In Canada, the furnaces must be vented in accordance with the National Standard of Canada, CAN/CSA B149.1 and CAN/CSA B149.2 - latest editions and amendments.

**NOTE:** The vertical height of the Category I venting system must be at least as great as the horizontal length of the venting system.

**⚠ WARNING**

**TO PREVENT POSSIBLE PERSONAL INJURY OR DEATH DUE TO ASPHYXIATION, COMMON VENTING WITH OTHER MANUFACTURER'S INDUCED DRAFT APPLIANCS IS NOT ALLOWED.**

The minimum vent diameter for the Category I venting system is as shown:

MODEL	MINIMUM VENT	
	UPFLOW	COUNTERFLOW
45	4 Inch	4 Inch
70	4 Inch	4 Inch
90	4 Inch	4 Inch
115	5 Inch	5 Inch
140	5 Inch	5 Inch

Under some conditions, larger vents than those shown above may be required or allowed. *When an existing furnace is removed from a venting system serving other appliances, the venting system may be too large to properly vent the remaining attached appliances.*

**Upflow or Horizontal units** are shipped with the induced draft blower discharging from the top of the furnace. ("Top" is as viewed for an upflow installation.) The induced draft blower can be rotated 90 degrees for Category I venting. For horizontal installations, a four inch single wall pipe can be used to extend the induced draft blower outlet 1/2" beyond the furnace cabinet. Vent the furnace in

accordance with the National Fuel Gas Code NFPA 54/ANSI Z223.1 - latest edition. In Canada, vent the furnace in accordance with the National Standard of Canada, CAN/CSA B149.1 and CAN/CSA B149.2 - latest editions and amendments.

**Venting**

THIS FURNACE IS NOT DESIGN CERTIFIED TO BE HORIZONTALLY VENTED.

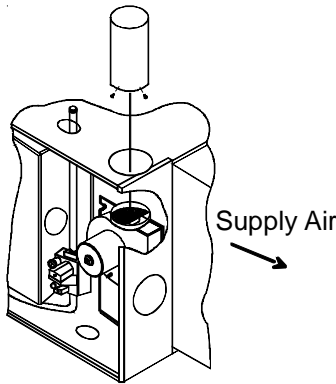

**Upflow Rotated Induced Draft Blower**

To rotate the induced draft blower, proceed as follows:

1. Disconnect electrical power from the furnace.
2. Disconnect the induced draft blower power leads, flue pipe, and pressure switch tubing.
3. Remove the round cutout from the appropriate side of the furnace.
4. Remove and save the four screws that hold the induced draft blower to the flue collector box.
5. Turn the induced draft blower 90 degrees clockwise, or counterclockwise. The gasket is adhered to the back plate and will rotate with the blower assembly.
6. Reinstall the induced draft blower on the flue collector box, using the four screws removed in Step 3. Tighten screws to provide an airtight seal.
7. Reconnect the induced draft blower power leads. NOTE: If the wires are not long enough, pull extra wire from the wire bundle in the blower compartment.
8. Remove and save the screw that holds the pressure switch to the furnace top panel.
9. Relocate the pressure switch to the same side as the flue outlet in the hole provided.
10. Reconnect the draft blower power leads, flue pipe, and pressure switch tubing. Make sure that all wires and the pressure switch tubing are at least one inch from the flue pipe, or any other hot surfaces.
11. Restore power to the furnace.

**Counterflow units** are shipped with the induced draft blower discharging from the top of the furnace. ("Top" as viewed for a counterflow installation.) Vent the furnace in accordance with the National Fuel Gas Code NFPA 54/ANSI Z223.1 - latest edition. In Canada, vent the furnace in accordance with the National Standard of Canada, CAN/CSA B149.1 AND CAN/CSA B149.2 - latest editions and amendments.

**VII. EXTERIOR MASONRY CHIMNEYS - CATEGORY I FURNACES ONLY**

An exterior masonry chimney is defined as a "Masonry chimney exposed to the outdoors on one or more sides below the roof line." The ability to use a clay lined masonry chimney depends on a parameter not associated with interior chimneys. This variable is the geographic location of the installation. Researchers have discovered that the winter design temperatures have a direct impact on the suitability of this type of venting. In most situations, the existing masonry chimneys will require a properly sized metallic liner.

**⚠ WARNING**

**POSSIBILITY OF PROPERTY DAMAGE, PERSONAL INJURY OR DEATH DAMAGING CONDENSATION CAN OCCUR INSIDE MASONRY CHIMNEYS WHEN A SINGLE FAN ASSISTED CATEGORY I APPLIANCE (80% AFUE FURNACE) IS VENTED WITHOUT ADEQUATE DILUTION AIR. DO NOT CONNECT AN 80% FURNACE TO A MASONRY CHIMNEY UNLESS THE FURNACE IS COMMON VENTED WITH A DRAFT HOOD EQUIPPED APPLIANCE OR THE CHIMNEY IS LINED WITH A METAL LINER OR TYPE B METAL VENT. ALL INSTALLATIONS USING MASONRY CHIMNEYS MUST BE SIZED IN ACCORDANCE WITH THE APPROPRIATE VENTING TABLES. IF AN 80% FURNACE IS COMMON VENTED WITH A DRAFT HOOD EQUIPPED APPLIANCE, THE POTENTIAL FOR CONDENSATION DAMAGE MAY STILL EXIST WITH EXTREMELY COLD CONDITIONS, LONG VENT CONNECTORS, EXTERIOR CHIMNEYS, OR ANY COMBINATION OF THESE CONDITIONS. THE RISK OF CONDENSATION DAMAGE IS BEST AVOIDED BY USING THE MASONRY CHIMNEY AS A PATHWAY FOR PROPERLY SIZED METAL LINER OR TYPE B METAL VENT.**

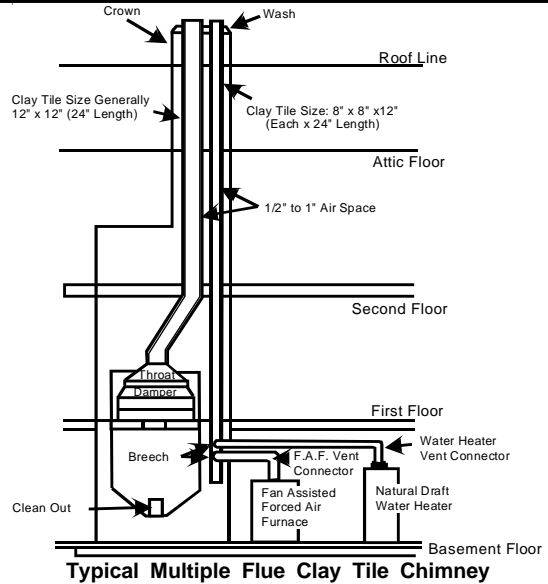

**CHECKLIST SUMMARY**

This checklist serves as a summary of the items to be checked before venting an 80+ furnace into a masonry chimney. In addition, we recommend that a qualified serviceman use this checklist to perform a yearly inspection of the furnace venting system.

This checklist is only a summary. For detailed information on each of the procedures mentioned, see the paragraph referenced with each item.

This inspection is based upon a draft topical report, "Masonry Chimney Inspection and Relining", issued by the Gas Research Institute. While not yet finalized, we believe this report represents the best information on this subject which is currently available.

**⚠ WARNING**

**NEVER ALLOW THE PRODUCTS OF COMBUSTION, INCLUDING CARBON MONOXIDE, TO ENTER THE RETURN DUCTWORK OR CIRCULATION AIR SUPPLY.**

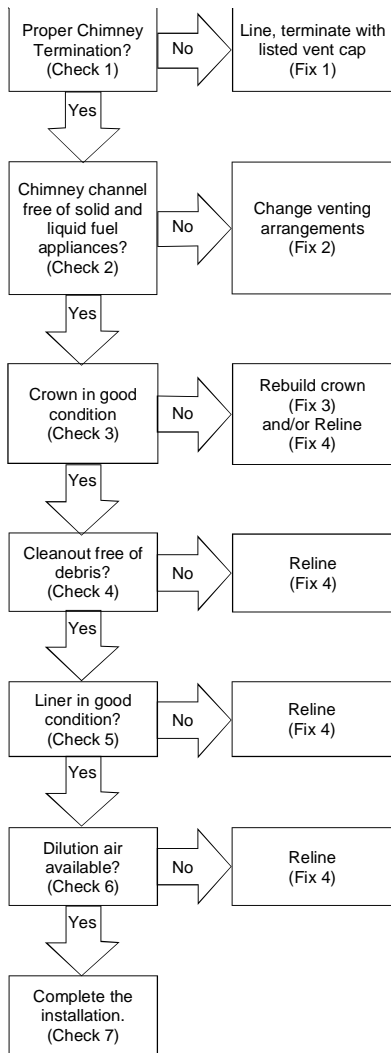

**CHECK 1 - PROPER CHIMNEY TERMINATION.**

A masonry chimney used as a vent for gas fired equipment must extend at least three feet above the highest point where it passes through the roof. It must extend at least two feet higher than any portion of a building within a horizontal distance of 10 feet. In addition, the chimney must terminate at least 3 feet above any forced air inlet located within 10 feet. The chimney must extend at least five feet above the highest connected equipment draft hood outlet or flue collar.

If the chimney does not meet these termination requirements, but all other requirements in the checklist can be met, it may be possible for a mason to extend the chimney. If this will not be practical, see Fix 1.

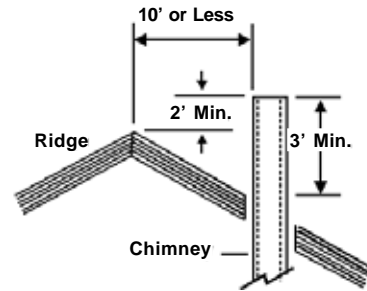
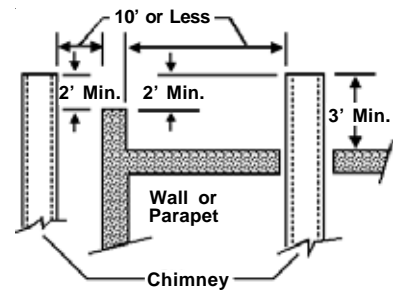

Termination 10 Feet Or Less From Ridge, Wall or Parapet

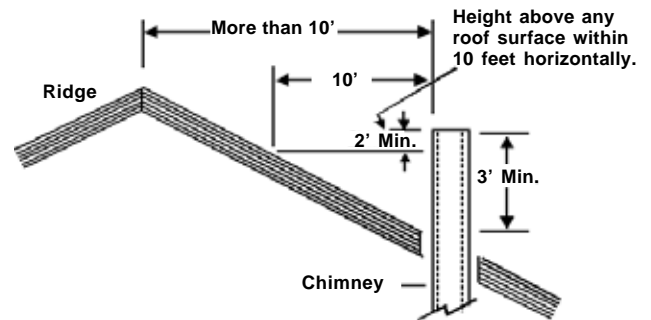
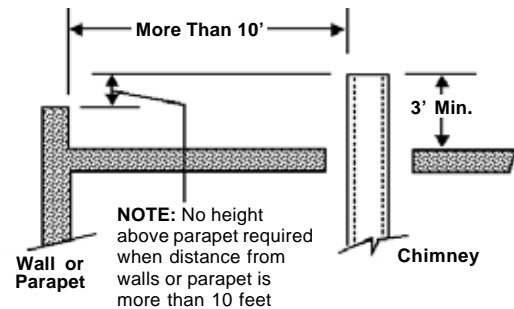

Termination More Than 10 Feet From Ridge, Wall or Parapet

**CHECK 2 - ANY SOLID OR LIQUID FUEL APPLIANCES VENTED INTO THIS CHIMNEY CHANNEL**

Solid fuel appliances include fireplaces, wood stoves, coal furnaces, and incinerators.

Liquid fuel appliances include oil furnaces, oil-fired boilers and oil-fired water heaters.

Appliances which burn propane (sometimes referred to as LP (liquefied petroleum)) gas are considered gas-fired appliances.

**CHECK 3 - CHIMNEY CROWN CONDITION.**

Damage from condensate usually shows up first in the crown. If any of the following trouble signs are present, the condition of the crown is not satisfactory:

- a) Crown leaning
- b) Bricks missing

- c) Mortar missing
- d) Tile liner cracked
- e) No tile liner
- f) Salt staining at mortar joints. (White stains, and mortar becomes sandy and/or erodes.)

For problems a, b, or c, see Fix 3. If problems d, e, or f are present, see Fix 4. **IMPORTANT:** It may be necessary to follow both Fix 3 and Fix 4.

#### **CHECK 4 - DEBRIS IN CLEANOUT**

A cleanout (dropleg) must be present such that the upper edge of the cleanout cover is at least 12 inches below the lower edge of the lowest chimney inlet opening.

A chimney without a cleanout could become partially blocked by debris. If no cleanout is present, the chimney must be refined (Fix 4). Remove the cleanout cover, and examine the cleanout for debris. If significant amounts of any of the following are found:

- Fuel oil residue
- Bricks
- Mortar or sand
- Pieces of the tile liner
- Rusted pieces of the metallic liner - reline the chimney (Fix 4).

#### **CHECK 5 - LINER CONDITION.**

If a metal liner is present, it must be checked. It cannot be assumed that all existing metal liners are correctly installed and in good condition.

Remove the lowest existing vent connector, and examine the inside of the elbow or tee at the base of the liner. A small amount of soot may be considered acceptable, provided the installer vacuums it away. If rusted pieces of the liner have collected here, the metal liner must be removed and replaced (Fix 4).

Next, gently tap the inside of the liner with a Phillips screwdriver. If the screwdriver perforates the liner, or if the tapping does not sound like metal hitting metal, the liner must be removed and replaced (Fix 4).

Remember that all appliances must be vented inside the liner. Venting one appliance inside the liner and another appliance outside the liner is not acceptable.

Next, use a flashlight and small mirror to sight up the liner. A vent must be supported so as to not come into direct contact with the chimney walls or tile liner. If it is not, it can probably be rehung so as to be acceptable. A thimble or fire stop may be helpful here.

Flexible liners should be hung straight or nearly straight. If it is spiraled in the chimney and in good condition, it should be rehung. To do this, break the top seal; pull up and cut off the excess liner length, and refit the top seal. Use caution when doing this, as the cut edges of flexible liners may be sharp.

The surfaces of the liner must be physically sound. If gaps or holes are present, the metal liner must be removed and replaced (Fix 4). Finally, confirm that the metal liner is the correct size for the appliances to be installed. Use the GAMA tables and rules.

If a metal liner is not present, a clay tile liner must be present, or the chimney must be lined (Fix 4).

Use a flashlight and small mirror at the cleanout or vent connector to inspect the clay tile liner. If any of the following problems are present:

- Tile sections misaligned
- Tile sections missing

- Gaps between tile sections
- Signs of condensate drainage at the cleanout or vent connectors
- Mortar protruding from between tile sections
- Use of sewer pipe or drainage pipe rather than an approved fire clay tile reline the chimney (Fix 4).

Next, measure the size of the liner. It may be possible to do this from the cleanout. The liner must be at least as large as the minimum size established by the tables in National Fuel Gas Code NFPA 54/ANSI Z223.1 - latest edition and in the National Standard of Canada, CAN/CSA B149.1 and CAN/CSA B149.2 - latest editions and amendments. If the liner is too small or too large, then the chimney must be relined (Fix 4).

#### **CHECK 6 - DILUTION AIR.**

If gas-fired appliances are to be vented into a clay tile liner, a source of dilution air is required.

Dilution air cannot be obtained through:

- Induced draft appliances
- Natural draft appliances with vent dampers

Sufficient dilution air can ordinarily be obtained through the draft hood of a natural draft appliance only if the appliance's vent connector does not include a vent damper. If dilution air will not be available, the chimney must be relined (Fix 4).

#### **CHECK 7 - COMPLETE THE INSTALLATION.**

If Checks 1 through 6 have been satisfactory, and the liner is an acceptable size as determined by the tables in National Fuel Gas Code NFPA 54/ANSI Z223.1 - latest edition and in the National Standard of Canada, CAN/CSA B149.1 and CAN/CSA B149.2 - latest editions and amendments, then the clay tile liner can probably be used as a vent for the gas appliances. However, the installer must keep in mind the following factors which may render the tile liner unsuitable for use as a vent:

- Extremely cold weather
- Long vent connectors
- Masonry chimneys with no air gap between the liner and the bricks. (In practice, this can be difficult to detect.)
- Exterior chimneys (The tables in National Fuel Gas Code NFPA 54/ANSI Z223.1 - latest edition and in the National Standard of Canada, CAN/CSA B149.1 and CAN/CSA B149.2 - latest editions and amendments assume interior chimneys.)

If, in the judgment of the local gas utility, installer, and/or local codes; one or more of the above factors is likely to present a problem, the chimney must be relined (Fix 4).

#### **Fix 1 - LINER TERMINATION**

Any cap or roof assembly used with a liner must be approved by the liner manufacturer for such use. The liner and cap/roof assembly must then terminate above the roof in accordance with the manufacturer's instructions.

In some cases, a shorter extension above the roof may be possible with a liner than would be required with a masonry chimney.

For further information on relining, see Fix 4.

## Fix 2 - CHANGE VENTING ARRANGEMENTS

If the masonry chimney has more than one channel, it may be possible to vent the gas appliances into one channel and vent the solid or liquid fuel appliance(s) into another channel(s). Do not vent an 80+ Furnace inside of a metal liner with other appliances vented outside the liner.

Alternatively, the homeowner may agree to discontinue use of the fireplace (solid fuel appliance). If so, the tile liner must be cleaned to remove creosote buildup. The fireplace opening must then be permanently sealed.

If oil-fired appliance(s) are being replaced by gas-fired appliance(s), the tile liner must first be cleaned to remove the fuel oil residue.

If none of the above options is practical, the 80% furnace may need to be vented vertically with a B Vent.

Under some conditions, a 90%+ furnace could be installed rather than an 80% furnace. A 90%+ furnace can be vented horizontally or vertically through PVC pipe.

## Fix 3 - REBUILD THE CROWN

If the chimney crown is damaged, a qualified mason must repair it in accordance with nationally recognized building codes or standards. One such standard which may be referenced is the Standard for Chimneys, Fireplaces, Vents, and Solid Fuel Burning Appliances, ANSI/NFPA 211.

## Fix 4 - RELINING

Relining options include B vent and flexible liners.

If the chimney has diagonal offsets, B vent probably cannot be used.

If B vent is to be used, it must be supported adequately. Supports (such as fire stops or thimbles) must be used to prevent the B vent from coming into direct contact with the tile liner or chimney walls. Direct contact would result in higher heat loss, with an increased possibility of poor venting system performance.

It is not acceptable to vent one appliance inside the B vent and other appliances outside. The excess space between the B vent and the chimney walls must be covered at the top of the chimney by a weatherproof, corrosion resistant flashing.

The B vent should then be topped with a listed vent cap. The listed vent cap will, when installed per the manufacturer's instructions, prevent problems due to rain, birds, or wind effects.

A B-vent installed as described in this section is considered to be an enclosed vent system, and the sizing tables in National Fuel Gas Code NFPA 54/ANSI Z223.1 - latest edition and in the National Standard of Canada, CAN/CSA B149.1 and CAN/CSA B149.2 - latest editions and amendments may be used.

If a flexible liner is to be used, it must be made of the proper materials:

- For most residential applications, an aluminum liner should be acceptable.
- If the combustion air supplied to the furnace will be contaminated with compounds containing chlorine or fluorine, a liner of AL 29-4C stainless steel should be used. Common sources of chlorine and fluorine compounds include indoor swimming pools and chlorine

bleaches, paint strippers, adhesives, paints, varnishes, sealers, waxes (which are not yet dried) and solvents used during construction and remodeling. Various commercial and industrial processes may also be sources of chlorine/fluorine compounds.

- Heavier gauge 300 and 400 series stainless steel liners were developed for use with oil or solid fuel appliances. They are not suitable for use with gas-fired appliances. Flexible liners specifically intended and tested for gas applications are listed in the UL "Gas and Oil Equipment Directory". (UL Standard 1777).

For sizing of flexible liners, see Note 22 and the tables in the National Fuel Gas Code NFPA 54/ANSI Z223.1 - latest edition and in the National Standard of Canada, CAN/CSA B149.1 and CAN/CSA B149.2 - latest editions and amendments.

To install the liner, read and follow the liner manufacturer's instructions and your local codes. Excess liner length should be pulled out of the chimney and cut off. Use caution when doing this, as the cut edges of flexible liners may be sharp. Do not spiral excess liner inside of the chimney. Support the liner as recommended by the liner manufacturer.

Some manufacturers of flexible liners offer an insulation sleeve designed to be added to the liner before it is installed in the chimney. (Poured insulation, either vermiculite or other materials, is no longer recommended.) Insulation will need to be added to the flexible liner if:

- It is required by the liner manufacturer's instructions.
- The previous liner was properly sized and installed, and suffered from condensation damage.
- It is required by your local building codes.

Even if none of those three conditions exist which require additional liner insulation, the installer may wish to consider it if:

- The local climate is very cold.
- The chimney is very tall.
- The vent connectors used are very long or have a large number of elbows.
- Local experience indicates that flexible liners installed without insulation are likely to have condensation problems.

Insulation must be selected and installed in accordance with the liner manufacturer's instructions.

Finally, cap the chimney and terminate the liner in accordance with the liner manufacturer's instructions.

## VIII. ELECTRICAL CONNECTIONS

### WARNING

TO AVOID THE RISK OF ELECTRICAL SHOCK, WIRING TO THE UNIT MUST BE POLARIZED AND GROUNDED.

### WARNING

TO AVOID INJURY, ELECTRICAL SHOCK OR DEATH, DISCONNECT ELECTRICAL POWER BEFORE SERVICING OR CHANGING ANY ELECTRICAL WIRING.

### CAUTION

LABEL ALL WIRES PRIOR TO DISCONNECTION WHEN SERVICING CONTROLS. WIRING ERRORS CAN CAUSE IMPROPER AND DANGEROUS OPERATION. VERIFY PROPER OPERATION AFTER SERVICING.

**! WARNING**

TO AVOID THE RISK OF INJURY, ELECTRICAL SHOCK OR DEATH, THE FURNACE MUST BE ELECTRICALLY GROUNDED IN ACCORDANCE WITH LOCAL CODES OR, IN THEIR ABSENCE, WITH THE LATEST EDITION OF THE NATIONAL ELECTRIC CODE.

### WIRING HARNESS

The wiring harness is an integral part of this furnace. Field alteration to comply with electrical codes should not be required. Wires are color coded for identification purposes. Refer to the wiring diagram for wire routings. If any of the original wire as supplied with the furnace must be replaced, it must be replaced with wiring material having a temperature rating of at least 105° C. Any replacement wiring must be a copper conductor.

### 115 VOLT LINE CONNECTIONS

Before proceeding with electrical connections, ensure that the supply voltage, frequency, and phase correspond to that specified on the unit rating plate. Power supply to the furnace must be NEC Class 1, and must comply with all applicable codes. The furnace must be electrically grounded in accordance with local codes or, in their absence, with the latest edition of The National Electric Code, ANSI NFPA 70 and/or The Canadian Electric Code CSA C22.1.

Use a separate fused branch electrical circuit containing properly sized wire, and fuse or circuit breaker. The fuse or circuit breaker must be sized in accordance with the maximum overcurrent protection specified on the unit rating plate. An electrical disconnect must be provided at the furnace location.

*Line voltage wiring* must enter into the junction box provided with the furnace.

**NOTE:** Line polarity must be observed when making field connections.

### FOSSIL FUEL APPLICATIONS

This furnace can be used in conjunction with a heat pump in a fossil fuel application. A fossil fuel application refers to a combined gas furnace and heat pump installation which uses an outdoor temperature sensor to determine the most cost efficient means of heating (heat pump, gas furnace, or both).

A heat pump thermostat with *two stages of heat* is required to properly use a furnace in conjunction with a heat pump. Refer to the fossil fuel kit installation instructions for additional thermostat requirements.

Strictly follow the wiring guidelines in the fossil fuel kit installation instructions. All furnace connections must be made to the furnace integrated control module and the FURNACE terminal strip on the fossil fuel control board.

### JUNCTION BOX RELOCATION

**! WARNING**

TO AVOID THE RISK OF INJURY, ELECTRICAL SHOCK OR DEATH, THE FURNACE MUST BE ELECTRICALLY GROUNDED IN ACCORDANCE WITH LOCAL CODES OR, IN THEIR ABSENCE, WITH THE LATEST EDITION OF THE NATIONAL ELECTRIC CODE.

**! WARNING**

EDGES OF SHEET METAL HOLES MAY BE SHARP. USE GLOVES AS A PRECAUTION WHEN REMOVING HOLE PLUGS.

Line voltage connections can be made through either the right or left side panel. The furnace is shipped configured for a left side electrical connection. To make electrical connections through the opposite side of the furnace, the junction box must be relocated to the left side prior to making electrical connections. To relocate the junction box, perform the following steps.

**! WARNING**

TO PREVENT PERSONAL INJURY OR DEATH DUE TO ELECTRIC SHOCK, DISCONNECT ELECTRICAL POWER.

1. Remove both doors from the furnace.
2. Remove and save the screws holding the junction box to the left side of the furnace.
3. Models that have the junction box located in the blower compartment will need to rotate the junction box 180 degrees. Models that have the junction box located in the burner compartment will need to move the junction box directly over.
4. Attach the junction box to the right side of the furnace, using the screws removed in step 2.
5. Check the location of the wiring. Confirm that it will not be damaged by heat from the burners or by the rotation of the fan. Also confirm that wiring location will not interfere with filter removal or other maintenance.

After the junction box is in the desired location, use washers to connect field-supplied conduit to the junction box in accordance with NEC and local codes. Connect hot, neutral, and ground wires as shown in the furnace wiring diagram. The wires and ground screw are located in the furnace junction box.

Low voltage wires may be connected to the terminal strip.

**IMPORTANT NOTE:** To avoid possible equipment malfunction, route the low voltage wires to avoid interference with filter removal or other maintenance.

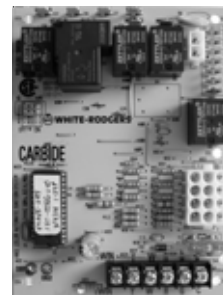

Integrated Ignition Control

**! WARNING**

TO AVOID THE RISK OF INJURY, ELECTRICAL SHOCK OR DEATH, THE FURNACE MUST BE ELECTRICALLY GROUNDED IN ACCORDANCE WITH LOCAL CODES OR, IN THEIR ABSENCE, WITH THE LATEST EDITION OF THE NATIONAL ELECTRIC CODE.

To ensure proper unit grounding, the ground wire should run from the furnace ground screw located inside the furnace junction box all the way back to the electrical panel. **NOTE:** Do not use gas piping as an electrical ground. To confirm proper unit grounding, turn off the electrical power and perform the following check.

1. Measure resistance between the neutral (white) connection and one of the burners.
2. Resistance should measure 10 ohms or less.

This furnace is equipped with a blower door interlock switch which interrupts unit voltage when the blower door is opened for servicing. Do not defeat this switch.

## 24 VOLT THERMOSTAT WIRING

**NOTE:** Wire routing must not interfere with circulator blower operation, filter removal, or routine maintenance.

Low voltage connections can be made through either the right or left side panel. Thermostat wiring entrance holes are located in the blower compartment. The following figure shows connections for a “heat only” system and “heat/cool system”.

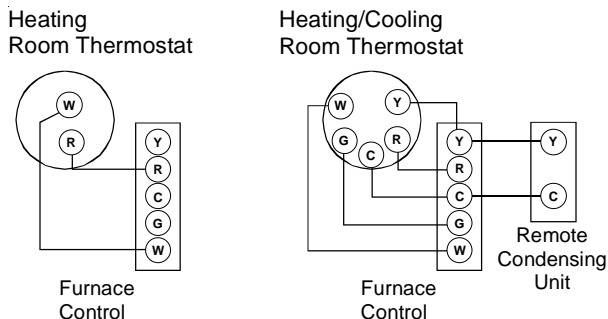

Typical Field Wiring (24 VAC Control Circuit)

This furnace is equipped with a 40 VA transformer to facilitate use with most cooling equipment. Consult the wiring diagram, located on the blower compartment door, for further details of 115 Volt and 24 Volt wiring.

A single-stage thermostat with only one heating stage can be used to control this furnace.

## SETTING THE HEAT ANTICIPATOR

The following method should be used in measuring the amp draw of the control circuit to assure proper adjustment of the thermostat heat anticipator

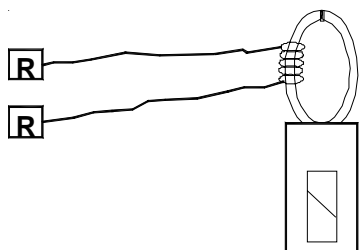

- Wrap the “R” leg around a clip-on ammeter 10 times.
- Energize the furnace in the heat mode.
- Record the reading.
- Divide this reading by 10.
- Set the heat anticipator on the thermostat to match this reading.

Example: If the reading on the ammeter is “4”, divide this by 10. The anticipator setting will be .4 amps.

## 24 VOLT HUMIDIFIER

The yellow wire connected to the I.D. Blower pressure switch is powered anytime the pressure switch is closed and provides 24 VAC humidifier control. Remove the yellow wire and connect the supplied brown jumper wire to the pressure switch terminal.

Reconnect the yellow wire to the “piggyback” terminal on the brown jumper and then connect the 24 VAC line of the humidifier to the stripped end of the brown wire. Using a wire nut or a field-supplied quick connect terminal can make this connection. The wiring must conform to all local and national codes. Connect the COM side of the humidifier to the B/C terminal on the furnace control board (or to the COM side of the 24 VAC transformer). **DO NOT CONNECT 115V HUMIDIFIER TO THESE TERMINALS.**

## IX. GAS SUPPLY AND PIPING

### GENERAL

The furnace rating plate includes the approved furnace gas input rating and gas types. The furnace must be equipped to operate on the type of gas applied. This includes any conversion kits required for alternate fuels and/or high altitude.



**TO PREVENT UNRELIABLE OPERATION OR EQUIPMENT DAMAGE, THE INLET GAS SUPPLY PRESSURE MUST BE AS SPECIFIED ON THE UNIT RATING PLATE WITH ALL OTHER HOUSEHOLD GAS FIRED APPLIANCES OPERATING.**

Inlet gas supply pressures must be maintained within the ranges specified in the following table. The supply pressure must be constant and available with all other household gas fired appliances operating. The minimum gas supply pressure must be maintained to prevent unreliable ignition. The maximum must not be exceeded to prevent unit overfiring.

Inlet Gas Supply Pressure		
Natural Gas	Minimum: 5.0" w.c.	Maximum: 10.0" w.c.
Propane Gas	Minimum: 11.0" w.c.	Maximum: 13.0" w.c.

**NOTE:** Adjusting the minimum supply pressure below the limits in the above table could lead to unreliable ignition. Gas input to the burners must not exceed the rated input shown on the rating plate. Overfiring of the furnace can result in premature heat exchanger failure. Gas pressures in excess of 13 inches water column can also cause permanent damage to the gas valve.

At all altitudes, the manifold pressure must be within 0.3 inches w.c. of that listed in the Product Data Book applicable to your model for the fuel used. At all altitudes and with either fuel, the air temperature rise must be within the range listed on the furnace nameplate. Should this appliance be converted to LP, refer to the instructions included in the factory authorized LP conversion kit .

### HIGH ALTITUDE DERATE

**IMPORTANT NOTE:** The furnace will naturally derate itself with altitude. Do not attempt to increase the firing rate by changing orifices or increasing the manifold pressure. This can cause poor combustion and equipment failure.

When this furnace is installed at high altitude, the appropriate High Altitude orifice kit must be applied. The furnace is supplied with orifices sized for natural gas at altitudes up to 4,500 feet using a heating value of approximately 1,000 Btu/hr, and should not normally require change. Most cases will not require a change at altitudes up to 7,500 feet. For use at altitudes in excess of 4,500 feet, refer to the following table for maximum input rates based on altitude. Contact your local gas utility for the heating value of the gas. Refer to National Fuel Gas Code ANSI Z223.1 and the following section to calculate firing rates.

### Maximum Firing Rates At Altitude

Altitude (ft)	Model (Kbtu/hr)				
	45	70	90	115	140
5,000	39,000	58,500	78,000	97,500	117,000
7,500	35,000	52,500	70,000	87,500	105,000
10,000	34,000	51,000	68,000	77,000	92,400

\* Firing rates may be lower than listed in table

It is important to check and adjust the input rate of the furnace to prevent an overfiring situation. Overfiring can cause premature heat exchanger failure. The input is controlled by the supply pressure, orifice size, manifold pressure and heating (calorific) value of the gas.

The supply pressure must be measured with this and all other gas burning appliances in operation. The supply pressure must be adjusted to the pressure range stated on the rating plate. Applications for altitudes in excess of 4,500 feet usually require an orifice change.

### ALTERNATE HIGH ALTITUDE DERATE

Alternately standard derate for altitude from National Fuel Gas Code ANSI Z223.1 of 4% per 1000' may be taken. Refer to the most recent version of ANSI Z223.1 for correct gas orifice. The orifices must be selected using the table below. The furnace derate is 4% for each 1,000 feet above sea level. This table is based upon a heating value of approximately 1,000 Btu/ft<sup>3</sup>

ALTITUDE	NAT. GAS ORIFICE SIZE
0 - 2,000	#43
3,000	#44
4,000	#44
5,000	#45
6,000	#45
7,000	#46

The input to the furnace must be checked AFTER reorificing.

For altitudes above 4,500 feet, refer to appropriate section of the National Fuel Gas Code, ANSI Z223.1. To calculate the input of the furnace for installations in altitudes over 7,000 feet, use the following formula:

Corrected Input = Rating Plate Input - (Altitude X .04) X (Rating Plate Input / 1000)

Example:

Corrected input for a 90,000 Btu/hr. appliance installed at an altitude of 6,000 ft. utilizing natural gas with a heating value of 1,000 Btu/ft<sup>3</sup> is determined by-

Corrected Input = 90,000 - (6,000 X .04) X (90,000 / 1,000)

Corrected Input = 90,000 - (240 X 90)

Corrected Input = 90,000 - 21,600

Corrected Input = 68,400

### FIRING RATE

Using the orifices sized as shown in the table for 6,000 feet (#45), a meter time of 52.6 seconds is measured. The actual firing rate of the furnace is:

Input = 1,000 (heating value of the gas) X 3600 (constant) / 52.6 (meter time for 1 ft<sup>3</sup> of gas)

Input = 3,600,000 / 52.6

Input = 68,400 Btu/h

### Meter Time In Minutes and Seconds For Normal Input Rating of Furnaces Equipped For Use With Natural Gas

INPUT Btu/hr	METER SIZE FT <sup>3</sup>	HEAT VALUE 900		HEAT VALUE 1000		HEAT VALUE 1040		HEAT VALUE 1100	
		MIN.	SEC.	MIN.	SEC.	MIN.	SEC.	MIN.	SEC.
40,000	1	1	21	1	30	1	33	1	39
	10	13	30	15	00	15	36	16	30
60,000	1	0	54	1	00	1	03	1	06
	10	9	00	10	10	10	24	11	00
80,000	1	0	41	0	45	0	47	0	50
	10	6	45	7	30	7	48	8	15
100,000	1	0	32	0	36	0	37	0	40
	10	5	24	6	00	6	14	6	36
120,000	1	0	27	0	30	0	31	0	33
	10	4	30	5	00	5	12	5	30

In Canada, the rating plate input for the furnace apply to installations up to 4,500 feet (1370m) above sea level. Canadian certification applies to the installations of up to 4,500 feet above sea level. Installations above 4,500 feet are subject to acceptance by the local authorities having jurisdiction.

Do **not** derate the furnace by adjusting the manifold pressure to a lower pressure than specified on the furnace rating plate. The combination of the lower air density and a lower manifold pressure will prohibit the burner orifice from drawing the proper amount of air into the burner. This may cause incomplete combustion, flashback, and possible yellow tipping.

In some areas the gas supplier may artificially derate the gas in an effort to compensate for the effects of altitude. If the gas is artificially derated, the appropriate orifice size must be determined based upon the BTU/ft<sup>3</sup> content of the derated gas and the altitude. Refer to the National Fuel Gas Code, NFPA 54/ANSI Z223.1, and information provided by the gas supplier to determine the proper orifice size.

Some models require a pressure switch change due to the reduced air density above certain altitudes. Refer to the following table to determine proper pressure switch settings for your application.

A different pressure switch may be required at high altitude regardless of the BTU/ft<sup>3</sup> content of the fuel used. Contact your distributor for appropriate altitude ranges and pressure switch kits.

#### Pressure Switch Changes

Furnace input Kbtu/hr	Altitude (ft)	Switch Setting (inches w.c.)
45	8000'	0.55
70	NR	
90*	8000'	0.60
115	NR	
140	NR	

\* 904BNA does not require a switch change

### PROPANE GAS CONVERSION



**WARNING**

**POSSIBLE PROPERTY DAMAGE, PERSONAL INJURY OR DEATH MAY OCCUR IF THE CORRECT CONVERSION KITS ARE NOT INSTALLED. THE APPROPRIATE KITS MUST BE APPLIED TO INSURE SAFE AND PROPER FURNACE OPERATION. ALL CONVERSIONS MUST BE PERFORMED BY A QUALIFIED INSTALLER OR SERVICE AGENCY.**

This unit is configured for natural gas. The appropriate manufacturer's propane gas conversion kit, must be applied for propane gas installations. Refer to the "Propane Gas and/or High Altitude Installations" section for details.

Contact your distributor for a tabular listing of appropriate manufacturer's kits for propane gas and/or high altitude installations. The indicated kits must be used to insure safe and proper furnace operation. All conversions must be performed by a qualified installer, or service agency.

## GAS PIPING CONNECTIONS

### GENERAL



**TO AVOID POSSIBLE UNSATISFACTORY OPERATION OR EQUIPMENT DAMAGE DUE TO UNDERFIRING OF EQUIPMENT, USE THE PROPER SIZE OF NATURAL/PROPANE GAS PIPING NEEDED WHEN RUNNING PIPE FROM THE METER/TANK TO THE FURNACE.**

When sizing a trunk line, be sure to include all appliances which will operate simultaneously.

The gas piping supplying the furnace must be properly sized based on the gas flow required, specific gravity of the gas, and length of the run. The gas line installation must comply with local codes, or in their absence, with the latest edition of the National Fuel Gas Code, NFPA 54/ANSI Z223.1.

**Natural Gas Capacity of Pipe  
In Cubic Feet of Gas Per Hour (CFH)**

Length of Pipe in Feet	Nominal Black Pipe Size				
	1/2"	3/4"	1"	1 1/4"	1 1/2"
10	132	278	520	1050	1600
20	92	190	350	730	1100
30	73	152	285	590	980
40	63	130	245	500	760
50	56	115	215	440	670
60	50	105	195	400	610
70	46	96	180	370	560
80	43	90	170	350	530
90	40	84	160	320	490
100	38	79	150	305	460

(Pressure 0.5 psig or less and pressure drop of 0.3" W.C.; Based on 0.60 Specific Gravity Gas)

$$CFH = \frac{BTUH \text{ Furnace Input}}{\text{Heating Value of Gas (BTU/Cubic Foot)}}$$

To connect the furnace to the building's gas piping, the installer must supply a ground joint union, drip leg, manual shutoff valve, and line and fittings to connect to gas valve. In some cases, the installer may also need to supply a transition piece from 1/2" pipe to a larger pipe size.

The following stipulations apply when connecting gas piping.

- Use black iron or steel pipe and fittings for the building piping.
- Use pipe joint compound on male threads only. Pipe joint compound must be resistant to the action of the fuel used.
- Use ground joint unions.
- Install a drip leg to trap dirt and moisture before it can enter the gas valve. The drip leg must be a minimum of three inches long.
- Install a 1/8" NPT pipe plug fitting, accessible for test gage connection, immediately upstream of the gas supply connection to the furnace.
- Use two pipe wrenches when making connection to the gas valve to keep it from turning. The orientation of the gas valve on the manifold must be maintained as shipped from the factory.
- Install a manual shutoff valve between the gas meter and unit within six feet of the unit. If a union is installed, the union must be downstream of the manual shutoff valve, between the shutoff valve and the furnace.
- Tighten all joints securely.
- Connect the furnace to the building piping by one of the following methods:

- Rigid metallic pipe and fittings.
- Semi-rigid metallic tubing and metallic fittings. Aluminum alloy tubing must not be used in exterior locations.
- Use listed gas appliance connectors in accordance with their instructions. Connectors must be fully in the same room as the furnace.
- Protect connectors and semi-rigid tubing against physical and thermal damage when installed. Ensure aluminum-alloy tubing and connectors are coated to protect against external corrosion when in contact with masonry, plaster, or insulation, or subjected to repeated wetting by liquids such as water (except rain water), detergents, or sewage.

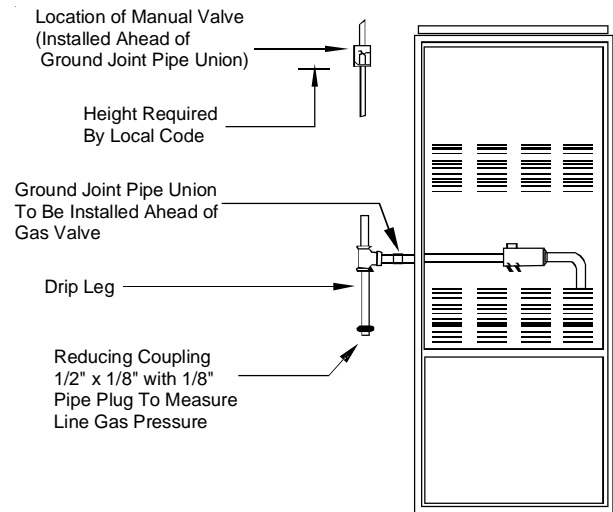

**General Furnace Layout**

### UPFLOW INSTALLATIONS

When the gas piping enters through the right side of the furnace, the installer must supply the following fittings (starting from the gas valve):

- 90 degree elbows (2).
- Close nipple.
- Straight pipe to reach the exterior of the furnace .

A ground joint union, drip leg, and manual shutoff valve must also be supplied by the installer. In some cases, the installer may also need to supply a transition piece from 1/2" to another pipe size.

When the gas piping enters through the left side of the furnace, the installer must supply the following fittings (starting from the gas valve):

- Straight pipe to reach the exterior of the furnace.
- A ground joint union, drip leg, and manual shutoff valve must also be supplied by the installer. In some cases, the installer may also need to supply a transition piece from 1/2 inch to another pipe size.

## COUNTERFLOW INSTALLATIONS

When the gas piping enters through the left side of the furnace, the installer must supply a straight pipe to reach the exterior of the furnace.

A ground joint union, drip leg, and manual shutoff valve must also be supplied by the installer. In some cases, the installer may also need to supply a transition piece from 1/2" to another pipe size. When the gas piping enters through the right side of the furnace, the installer must supply the following fittings (starting at the gas valve):

- 90 degree elbow.
- Close nipple.
- 90 degree elbow.
- Straight pipe to reach exterior of furnace.

## GAS PIPING CHECKS

Before placing unit in operation, leak test the unit and gas connections.

### WARNING

TO AVOID THE POSSIBILITY OF EXPLOSION OR FIRE, NEVER USE A MATCH OR OPEN FLAME TO TEST FOR LEAKS.

Check for leaks using an approved chloride-free soap and water solution, an electronic combustible gas detector, or other approved testing methods.

### CAUTION

TO PREVENT PROPERTY DAMAGE OR PERSONAL INJURY DUE TO FIRE, THE FOLLOWING INSTRUCTIONS MUST BE PERFORMED REGARDING GAS CONNECTIONS, PRESSURE TESTING, LOCATION OF SHUTOFF VALVE AND INSTALLATION OF GAS PIPING.

**NOTE:** Never exceed specified pressures for testing. Higher pressure may damage the gas valve and cause subsequent overfiring, resulting in heat exchanger failure.

Disconnect this unit and shutoff valve from the gas supply piping system before pressure testing the supply piping system with pressures in excess of 1/2 psig (3.48 kPa).

This unit must be isolated from the gas supply system by closing its manual shutoff valve before pressure testing of gas supply piping system with test pressures equal to or less than 1/2 psig (3.48 kPa).

## PROPANE GAS TANKS AND PIPING

### WARNING

IF THE GAS FURNACE IS INSTALLED IN A BASEMENT, AN EXCAVATED AREA OR A CONFINED SPACE, IT IS STRONGLY RECOMMENDED TO CONTACT A PROPANE SUPPLIER TO INSTALL A GAS DETECTING WARNING DEVICE IN CASE OF A GAS LEAK.

- **SINCE PROPANE GAS IS HEAVIER THAN AIR, ANY LEAKING GAS CAN SETTLE IN ANY LOW AREAS OR CONFINED SPACES.**
- **PROPANE GAS ODORANT MAY FADE, MAKING THE GAS UNDETECTABLE EXCEPT WITH A WARNING DEVICE.**

A gas detecting warning system is the only reliable way to detect a propane gas leak. Rust can reduce the level of odorant in propane gas. Do not rely on your sense of smell. Contact a local propane gas supplier about installing a gas detecting warning system. If the presence of gas is suspected, follow the instructions on Page 3 of this manual.

All propane gas equipment must conform to the safety standards of the National Board of Fire Underwriters, NBFU Manual 58.

For satisfactory operation, propane gas pressure must be 11 inch WC at the furnace manifold with all gas appliances in operation. Maintaining proper gas pressure depends on three main factors:

1. Vaporization rate, depending on temperature of the liquid, and "wetted surface" area of the container or containers.
2. Proper pressure regulation. (Two-stage regulation is recommended for both cost and efficiency).
3. Pressure drop in lines between regulators, and between second stage regulator and the appliance. Pipe size will depend on length of pipe run and total load of all appliances.

Complete information regarding tank sizing for vaporization, recommended regulator settings, and pipe sizing is available from most regulator manufacturers and propane gas suppliers.

Since propane gas will quickly dissolve white lead and most standard commercial compounds, special pipe dope must be used. Shellac-based compounds resistant to the actions of liquefied petroleum gases such as Gasolac<sup>®</sup>, Stalactic<sup>®</sup>, Clyde's<sup>®</sup> or John Crane<sup>®</sup> are satisfactory.

Refer to the following illustration for typical propane gas installations and piping.

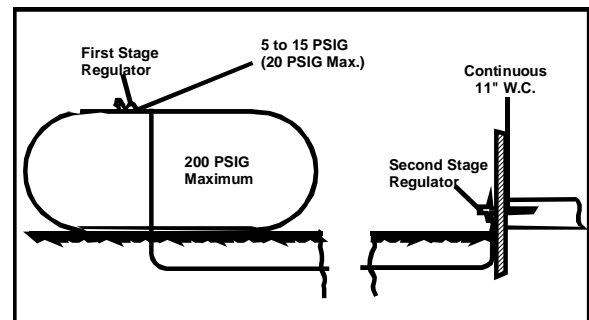

Propane Gas Installation (Typ.)

## PROPANE GAS PIPING CHARTS

Sizing Between First and Second Stage Regulator\*

Maximum Propane Capacities listed are based on 2 psig pressure drop at 10 psig setting.

Capacities in 1,000 BTU/hour.

Pipe or Tubing Length, Feet	Tubing Size, O.D. Type L					Nominal Pipe Size Schedule 40	
	3/8"	1/2"	5/8"	3/4"	7/8"	1/2"	3/4"
10	730	1,700	3,200	5,300	8,300	3,200	7,500
20	500	1,100	2,200	3,700	5,800	2,200	4,200
30	400	920	2,000	2,900	4,700	1,800	4,000
40	370	850	1,700	2,700	4,100	1,600	3,700
50	330	770	1,500	2,400	3,700	1,500	3,400
60	300	700	1,300	2,200	3,300	1,300	310
80	260	610	1,200	1,900	2,900	1,200	2,600
100	220	540	1,000	1,700	2,600	1,000	2,300
125	200	490	900	1,400	2,300	900	2,100
150	190	430	830	1,300	2,100	830	1,900
175	170	400	780	1,200	1,900	770	1,700
200	160	380	730	1,100	1,800	720	1,500

Sizing Between First and Second Stage Regulator\*

Maximum Propane Capacities listed are based on 2 psig pressure drop at 10 psig setting.

Capacities in 1,000 BTU/hour.

Pipe or Tubing Length, Feet	Tubing Size, O.D. Type L					Nominal Pipe Size Schedule 40					
	3/8"	1/2"	5/8"	3/4"	7/8"	1-1/8"	1/2"	3/4"	1"	1-1/4"	1-1/2"
10	39	92	199	329	501	935	275	567	1,071	2,205	3,307
20	26	62	131	216	346	630	189	393	732	1,496	2,299
30	21	50	107	181	277	500	152	315	590	1,212	1,858
40	19	41	90	145	233	427	129	267	504	1,039	1,559
50	18	37	79	131	198	376	114	237	448	91	1,417
60	16	35	72	121	187	340	103	217	409	834	1,275
80	13	29	62	104	155	289	89	185	346	724	1,066
100	11	26	55	90	138	255	78	162	307	630	976
125	10	24	48	81	122	224	69	146	275	567	866
150	9	21	43	72	109	202	63	132	252	511	787
200	8	19	39	66	100	187	54	112	209	439	665
250	8	17	36	60	93	172	48	100	185	390	590

## X. CIRCULATING AIR AND FILTERS

### Ductwork - Air



**WARNING**

**NEVER ALLOW THE PRODUCTS OF COMBUSTION, INCLUDING CARBON MONOXIDE, TO ENTER THE RETURN DUCTWORK OR CIRCULATION AIR SUPPLY.**

Duct systems and register sizes must be properly designed for the CFM and external static pressure rating of the furnace. Ductwork should be designed in accordance with the recommended methods of "Air Conditioning Contractors of America" Manual D.

A duct system must be installed in accordance with Standards of the National Board of Fire Underwriters for the Installation of Air Conditioning, Warm Air Heating and Ventilating Systems. Pamphlets No. 90A and 90B.

A closed return duct system must be used, with the return duct connected to the furnace. **NOTE: Ductwork must never be attached to the back of the furnace.** Supply and return connections to the furnace may be made with flexible joints to reduce noise transmission. To prevent the blower from interfering with combustion air or draft when a central return is used, a connecting duct must be installed between the unit and the utility room wall. A room, closet, or alcove must not be used as a return air chamber.

When the furnace is used in connection with a cooling unit, the furnace should be installed in parallel with or on the upstream side of the cooling unit to avoid condensation in the heating element. With a parallel flow arrangement, the dampers or other means used to control the flow of air must be adequate to prevent chilled air from entering the furnace and, if manually operated, must be equipped with means to prevent operation of either unit unless the damper is in the full heat or cool position.

When the furnace is installed without a cooling coil, it is recommended that a removable access panel be provided in the outlet air duct. This opening shall be accessible when the furnace is installed and shall be of such a size that the heat exchanger can be viewed for visual light inspection or such that a sampling probe can be inserted into the airstream. The access panel must be made to prevent air leaks when the furnace is in operation.

When the furnace is heating, the temperature of the return air entering the furnace must be between 55°F and 100°F.

When a furnace is installed so that supply ducts carry air circulated by the furnace to areas outside the space containing the furnace, the return air shall also be handled by a duct sealed to the furnace casing and terminating outside the space containing the furnace.

## FILTERS - READ THIS SECTION BEFORE INSTALLING THE RETURN AIR DUCTWORK

Filters must be used with this furnace. Discuss filter maintenance with the building owner. Filters do not ship with this furnace, but must be provided by the installer. Filters must comply with UL900 or CAN/ULCS111 standards. If the furnace is installed without filters, the warranty will be voided.

**NOTE:** An undersized opening will cause reduced airflow. The bottom return is set up as a knock out.

## UPRIGHT INSTALLATIONS

Depending on the installation and/or customer preference, differing filter arrangements can be applied. Filters can be installed in the central return register or a side panel external filter rack kit (upflows), or the ductwork above a counterflow furnace. As an alternative, a media air filter or electronic air cleaner can be used as the requested filter.

## CIRCULATION AIR FILTERS

One of the most common causes of a problem in a forced air heating system is a blocked or dirty filter. Circulating air filters must be inspected monthly for dirt accumulation and replaced if necessary. Failure to maintain clean filters can cause premature heat exchanger failure.

A new home may require more frequent replacement until all construction dust and dirt is removed. Circulating air filters are to be installed in the return air duct external to the furnace cabinet.

### MINIMUM FILTER SIZES

FURNACE INPUT	FILTER SIZE	TYPE
45M	160 in <sup>2</sup>	permanent
70M	241 in <sup>2</sup>	permanent
90M	320 in <sup>2</sup>	permanent
115M	400 in <sup>2</sup>	permanent
140M	370 in <sup>2</sup>	permanent
45M	320 in <sup>2</sup>	disposable
70M	483 in <sup>2</sup>	disposable
90M	640 in <sup>2</sup>	disposable
115M	800 in <sup>2</sup>	disposable
140M	738 in <sup>2</sup>	disposable

PERMANENT: NOMINAL 600 F.M. FACE VELOCITY

DISPOSABLE: NOMINAL 300 F.M. FACE VELOCITY

## HORIZONTAL INSTALLATIONS

Filters must be installed in either the central return register or in the return air duct work.

## XI. SEQUENCE OF OPERATION (INTEGRATED IGNITION CONTROL)

### POWER UP

- 115 VAC power applied to furnace.
- Integrated ignition control performs internal checks.
- Integrated ignition LED will light.
- Integrated ignition control monitors safety circuits continuously.
- Furnace awaits call from thermostat.

### NORMAL HEATING SEQUENCE

The normal operational sequence in heating mode is as follows:

- R and W thermostat contacts close, initiating a call for heat.
- Integrated control module performs safety circuit checks.
- Induced draft blower is energized for 15 second prepurge period causing pressure switch contacts to close.
- Igniter warm up begins after 15 second prepurge expires.
- Gas valve opens at end of igniter warm up period, delivering gas to burners and establishing flame.
- Integrated control module monitors flame presence. Gas valve will remain open only if flame is sensed.
- Circulator blower is energized on heat speed following a fixed thirty second blower on delay.
- Furnace runs, integrated control module monitors safety circuits continuously.
- R and W thermostat contacts open, completing the call for heat.
- Gas valve closes, extinguishing flame.
- Induced draft blower is de-energized following a fifteen second post purge.
- Circulator blower is de-energized following the heat off delay period (fixed 150 seconds).
- Furnace awaits next call from thermostat.

### NORMAL COOLING SEQUENCE

- Thermostat calls for cooling.
- Integrated control module performs safety circuit checks.
- Outdoor fan and compressor are energized.
- Circulator blower is energized on cool speed following a fixed five second on delay.
- Furnace circulator blower and outdoor cooling unit run, integrated control module monitors safety circuits continuously.
- R and Y thermostat contacts open, completing the call for cool.
- Outdoor fan and compressor are de-energized.
- Circulator blower is de-energized following a fixed forty-five second cool off delay period.
- Furnace awaits the next call from the thermostat.

### FAN ONLY MODE

The normal operational sequence in fan only mode is as follows:

- R and G thermostat contacts close, initiating a call for fan.
- Integrated control module performs safety circuit checks.
- Circulator blower is energized on heat speed.
- Circulator blower runs, integrated control module monitors safety circuits continuously.
- R and G thermostat contacts open, completing the call for fan.
- Circulator blower is de-energized.
- Furnace awaits next call from thermostat.

## XII. START-UP PROCEDURE AND ADJUSTMENT

Furnace must have a 115 VAC power supply properly connected and grounded. Proper polarity must be maintained for correct operation. An interlock switch prevents furnace operation if the blower door is not in place. Keep the blower access door in place except for inspection and maintenance.

This furnace is also equipped with a self-diagnosing electronic control module. In the event a furnace component is not operating properly, the control module LED will flash on and off in a factory-programmed sequence, depending on the problem encountered. This light can be viewed through the observation window in the blower access door. Refer to the *Troubleshooting Chart* for further explanation of the lighting codes.

Follow the start-up and adjustment items, refer to further information in *Section XIII, Operational Checks*.

### FURNACE OPERATION

Purge gas lines of air prior to start-up. Do not purge lines into an enclosed burner compartment.

Check for leaks using an approved chloride-free soap and water solution, an electronic combustible gas detector, or other approved method. Verify that all required kits (propane gas, high altitude, etc.) have been appropriately installed.

**NOTE:** An interlock switch prevents furnace operation if the blower door is not in place. Keep the blower access doors in place except for inspection and maintenance.

### FURNACE START-UP

1. Close the manual gas shutoff valve external to the furnace.
2. Turn off the electrical power to the furnace.
3. Set the room thermostat to the lowest possible setting.
4. Remove the burner compartment door.

**NOTE:** This furnace is equipped with an ignition device which automatically lights the burner. Do not try to light the burner by hand.

5. *White-Rodgers Models 36F22/36G22:* Push the switch to the OFF position.
6. Wait five minutes to clear out any gas. Then smell for gas, including near the floor.

7. If gas can be smelled following the five minute waiting period in Step 6, immediately follow the instructions on Page 3 of this manual. If you do not smell gas after five minutes:  
*White-Rodgers Models 36F22/36G22:* Push the switch to the ON position.
8. Replace the door on the front of the furnace.
9. Open the manual gas valve external to the furnace.
10. Turn on the electrical power supply to the furnace.
11. Set the room thermostat to the desired temperature.

**NOTE:** There is an approximate 20 second delay between thermostat energizing and burner firing.

**FURNACE SHUTDOWN**

1. Set the thermostat to lowest setting.
2. Turn off the electrical power supply to the furnace.
3. *White-Rodgers Models 36F22/36G22:* Push switch to the OFF position.
4. Close manual gas shutoff valve external to the furnace.
5. Replace the door on the unit.

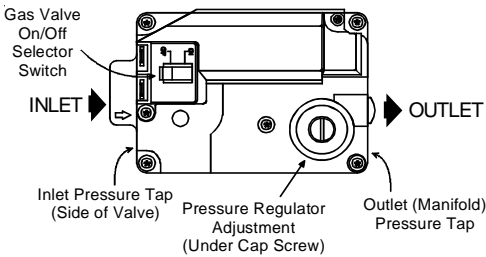

**White-Rodgers Model 36F22**

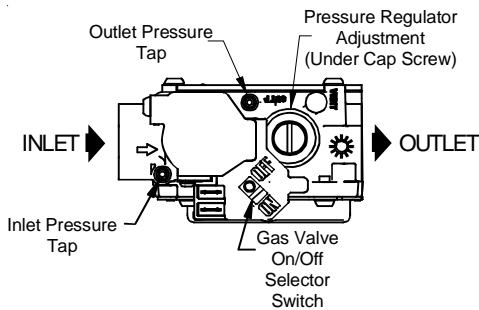

**White-Rodgers Model 36G22**

**GAS SUPPLY PRESSURE MEASUREMENT**

**CAUTION**

**TO PREVENT UNRELIABLE OPERATION OR EQUIPMENT DAMAGE, THE INLET GAS SUPPLY PRESSURE MUST BE AS SPECIFIED ON THE UNIT RATING PLATE WITH ALL OTHER HOUSEHOLD GAS FIRED APPLIANCES OPERATING.**

**WHITE-RODGERS 36F22 GAS VALVE**

The line pressure supplied to the gas valve must be within the range specified below. The supply pressure can be measured at the gas valve inlet pressure tap or at a hose fitting installed in the gas piping drip leg. The supply pressure must be measured with the burners operating. To measure the gas supply pressure, use the following procedure.

*With Power and Gas Off:*

1. Connect a water manometer or adequate gauge to the "inlet pressure tap" of the gas valve.

As an alternative method, inlet gas pressure can also be measured by removing the cap from the drip leg and installing a predrilled cap with a hose fitting.

*With Power and Gas On:*

2. Put furnace into heating cycle and turn on all other gas consuming appliances.

If operating pressures differ from the *Inlet Gas Supply Pressure* table, make necessary pressure regulator adjustments, check piping size, etc., and/or consult with local utility.

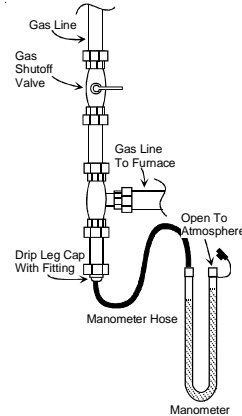

**Measuring Inlet Gas Pressure (Alternate Method)**

Inlet Gas Supply Pressure		
Natural Gas	Minimum: 5.0" w.c.	Maximum:10.0" w.c.
Propane Gas	Minimum: 11.0" w.c.	Maximum:13.0" w.c.

If supply pressure differs from table, make the necessary adjustments to pressure regulator, gas piping size, etc., and/or consult with local gas utility.

3. Turn OFF gas to furnace at the manual shutoff valve and disconnect manometer. Reinstall plug before turning on gas to furnace.
4. Turn OFF any unnecessary gas appliances started in step 2.

**WHITE-RODGERS 36G22 GAS VALVE**

The line pressure supplied to the gas valve must be within the range specified below. The supply pressure can be measured at the gas valve inlet pressure tap or at a hose fitting installed in the gas piping drip leg. The supply pressure must be measured with the burners operating. To measure inlet pressure, use the following procedure.

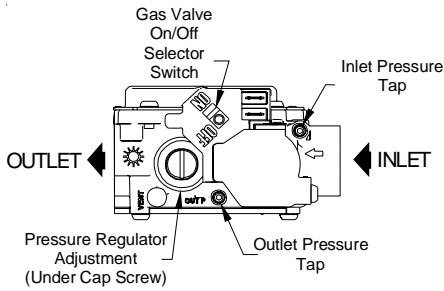

### White-Rodgers Model 36G22

1. Turn OFF gas to furnace at the manual gas shutoff valve external to the furnace.
2. Using 3/32 hex wrench, loosen inlet pressure tap screw one turn.
3. Connect a 5/16 inch hose and calibrated water manometer to the gas valve inlet pressure tap. The hose should overlap the tap by 3/8 inch.
4. Turn ON the gas supply and operate the furnace
5. Leak test. Using a leak detection solution or non-chlorine soap suds, check for leaks at hose connection. Bubbles forming indicate a leak. **SHUT OFF GAS AND FIX ALL LEAKS IMMEDIATELY BEFORE PROCEEDING TO NEXT STEP!**
6. Measure furnace gas supply pressure. Supply pressure must be within the range specified in the *Inlet Gas Supply Pressure* table.

If supply pressure reading differs from the table, make necessary adjustments to pressure regulator, gas piping size, etc., and/or consult with local gas utility.

Inlet Gas Supply Pressure		
Natural Gas	Minimum: 5.0" w.c.	Maximum: 10.0" w.c.
Propane Gas	Minimum: 11.0" w.c.	Maximum: 13.0" w.c.

7. Turn OFF gas to furnace at the manual shutoff valve and disconnect manometer and hose. Reinstall plug before turning on gas to furnace.
8. Seal pressure port. Tighten inlet pressure tap screw clockwise 7 in-lbs. minimum.
9. Retest for leaks. If bubbles form, shut down gas and fix leaks immediately.
10. Turn valve switch ON.

### GAS MANIFOLD PRESSURE MEASUREMENT AND ADJUSTMENT



**TO PREVENT UNRELIABLE OPERATION OR EQUIPMENT DAMAGE, THE GAS MANIFOLD PRESSURE MUST BE AS SPECIFIED ON THE UNIT RATING PLATE. ONLY MINOR ADJUSTMENTS SHOULD BE MADE BY ADJUSTING THE GAS VALVE PRESSURE REGULATOR.**

### WHITE-RODGERS 36F22 GAS VALVE

Only small variations in gas pressure should be made by adjusting the gas valve pressure regulator. The manifold pressure must be measured with the burners operating. To measure and adjust the manifold pressure, use the following procedure.

1. Turn OFF gas to furnace at the manual gas shutoff valve external to the furnace.
2. Connect a calibrated water manometer (or appropriate gas pressure gauge) at the gas valve outlet pressure tap (refer to gas valve figure in previous section).

3. Turn ON the gas supply and operate the furnace.
4. Measure gas manifold pressure with burners firing. Adjust manifold pressure according to the *Manifold Gas Pressure* table:

Manifold Gas Pressure		
Gas	Range	Nominal
Natural	3.2 - 3.8" w.c.	3.5" w.c.
Propane	9.7 - 10.3" w.c.	10.0" w.c.

The final manifold pressure must not vary more than  $\pm 0.3$  " w.c. from the above specified pressures. Any necessary major changes in gas flow rate should be made by changing the size of the burner orifice.

5. To adjust the gas valve pressure regulator, remove the regulator cap.
6. Turn the adjustment screw clockwise to increase the pressure, or counterclockwise to decrease the pressure.
7. Securely replace the regulator cap.
8. Turn OFF gas to furnace at the manual shutoff valve and disconnect manometer.
9. Reinstall gas valve outlet pressure tap plug before turning on gas to furnace.

### WHITE-RODGERS 36G22 GAS VALVE

This valve is shipped from the factory with the regulator preset (see control label).

Consult the appliance rating plate to ensure burner manifold pressure is as specified. If another outlet pressure is required, follow these steps.

1. Turn OFF all electrical power to the system.
2. Using a 3/32 inch hex wrench, loosen outlet pressure tap screw one turn. Do not remove screw.
3. Connect a calibrated water manometer and 5/16 inch hose to the gas valve outlet pressure tap. Hose should overlap tap by 3/8 inch.
4. Turn ON system power and set thermostat to a call for heat.
5. Using a leak detection solution or non-chlorine soap suds, check for leaks at hose connection. Bubbles forming indicate a leak. **SHUT OFF GAS AND FIX ALL LEAKS IMMEDIATELY!**
6. Remove regulator screw cover. Turn regulator screw either clockwise to increase pressure or counterclockwise to decrease. Always adjust regulator to provide the correct pressure according to the original equipment manufacturer specifications listed on the appliance rating plate.
7. Replace regulator screw cover and finger-tighten securely.
8. Turn OFF all electrical power to the system.
9. Remove manometer and hose from outlet pressure tap.
10. Tighten outlet pressure tap clockwise 7 in-lbs minimum to seal port.
11. Turn ON system power and set thermostat to call for heat.
12. Using a leak detection solution or non-chlorine soap suds, check for leaks at hose connection. Bubbles forming indicate a leak. **SHUT OFF GAS AND FIX ALL LEAKS IMMEDIATELY!**

Measure gas manifold pressure with burners firing. Adjust manifold pressure per the *Manifold Gas Pressure* table.

Manifold Gas Pressure		
Gas	Range	Nominal
Natural	3.2 - 3.8" w.c.	3.5" w.c.
Propane	9.7 - 10.3" w.c.	10.0" w.c.

The final manifold pressure must not vary more than  $\pm 0.3$  w.c. from specified manifold pressure.

Any necessary major changes in gas flow rate should be made by changing the size of the burner orifice.

### GAS INPUT RATE MEASUREMENT (NATURAL GAS ONLY)

The gas input rate to the furnace must never be greater than that specified on the unit rating plate. To measure natural gas input using the gas meter, use the following procedure.

1. Turn OFF the gas supply to all other gas-burning appliances except the furnace.
2. While the furnace is operating, time and record one complete revolution of the smallest gas meter dial.
3. Calculate the number of seconds per cubic foot (sec/ ft<sup>3</sup>) of gas being delivered to the furnace. If the dial is a one cubic foot dial, divide the number of seconds recorded in step 2 by one. If the dial is a two cubic foot dial, divide the number of seconds recorded in step 2 by two.
4. Calculate the furnace input in BTUs per hour (BTU/ hr). Input equals the installation's gas heating value multiplied by a conversion factor (hours to seconds) divided by the number of seconds per cubic foot. The measured input must not be greater than the input indicated on the unit rating plate.

EXAMPLE:

Installation's gas heating (HTG) value: 1,000 BTU/ft<sup>3</sup>  
(Obtained from gas supplier)

Installation's seconds per cubic foot: 34 sec/ ft<sup>3</sup>

Conversion Factor (hours to seconds): 3600 sec/hr

Input = (Htg. value x 3600) ÷ seconds per cubic foot

Input = (1,000 BTU/ft<sup>3</sup> x 3600 sec/hr) ÷ 34 sec/ ft<sup>3</sup>

Input = 106,000 BTU/hr

This measured input must not be greater than the input indicated on the unit rating plate.

5. Turn ON gas and relight appliances turned off in step 1. Ensure all the appliances are functioning properly and that all pilot burners are operating.

### TEMPERATURE RISE

Air temperature rise is the temperature difference between supply and return air. The proper amount of temperature rise is usually obtained when the unit is operated at the rated input with the "as shipped" blower speed. If the correct amount of temperature rise is not obtained, it may be necessary to change the blower speed.

An incorrect temperature rise can cause condensing in or overheating of the heat exchanger. Determine and adjust the temperature rise as follows. The temperature rise must be within the range specified on the rating plate or Product Data Book applicable to your model. *(Please contact your distributor or visit our website for the applicable Product Data Book referred to in this manual.)*

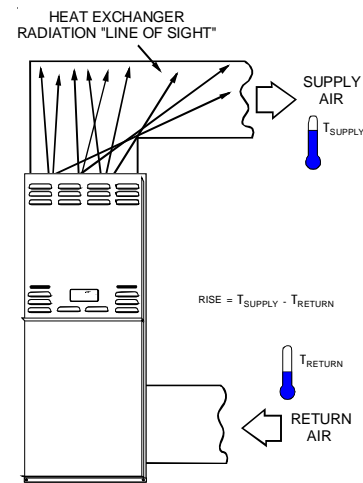

Temperature Rise Measurement

1. Operate furnace with burners firing approximately 15 minutes. Ensure all registers are open and all duct dampers are in their final (fully or partially open) position.
2. Place thermometers in the return and supply ducts as close to the furnace as possible. Thermometers must not be influenced by radiant heat by being able to "see" the heat exchanger.
3. Subtract the return air temperature from the supply air temperature to determine the air temperature rise. Allow adequate time for thermometer readings to stabilize.
4. Adjust temperature rise by adjusting the circulator blower speed. Increase blower speed to reduce temperature rise. Decrease blower speed to increase temperature rise. Refer to the following section for speed changing details.

### CIRCULATOR BLOWER SPEED ADJUSTMENT



**WARNING**

**TO AVOID PERSONAL INJURY OR DEATH DUE TO ELECTRICAL SHOCK, TURN OFF POWER TO THE FURNACE BEFORE CHANGING SPEED TAPS.**

This furnace is equipped with a PSC circulator blower motor. This blower provides ease in adjusting blower speeds. The Product Data Book applicable to your model provides an airflow table showing the relationship between airflow (CFM) and external static pressure (E.S.P.) and a table for the proper selection of heating and cooling speeds. The cooling blower speed is shipped set on HIGH. High heat ships on MEDIUM and low heat is shipped on MEDIUM-LO. These blower speeds should be adjusted by the installer to match the installation requirements so as to provide the correct heating temperature rise and the correct cooling CFM.

To adjust the circulator blower speed, proceed as follows:

1. Turn OFF power to the furnace.
2. Select the heating and cooling blower speeds that match the installation requirements from the airflow table in the Product Data Book applicable to your model.
3. Relocate desired motor leads to the circulator blower heat and cool speed terminals on the integrated control module. (Terminals are identified as HEAT and COOL (hot)). If heating and cooling blower speeds are the same, a jumper wire must be used between the heat and cool terminals.
4. Connect all unused blower motor leads to the "PARK" terminals on the integrated control module. Any leads not connected to the "PARK" terminals must be taped.
5. Turn ON power to furnace.
6. Verify proper temperature rise as outlined in *Temperature Rise section*.

### CIRCULATOR BLOWER FAN TIMING ADJUSTMENT

**NOTE:** Items in this section refer to the **air circulator blower fan**, **NOT** to the induced draft blower. The induced draft blower timing sequence is not adjustable. The circulator blower fan timing is adjustable only on models with optional "heating fan OFF delay" adjustment pins or switches. It is **NOT** adjustable in any other circumstances.

As shipped, the circulator blower fan will remain on for 150 seconds after the gas valve closes. When a call for cooling occurs, the circulator fan comes on and remains on for 45 seconds after the call for cooling ends. During normal heating operation, the circulator fan will come on approximately 34 seconds after the gas valve opens.

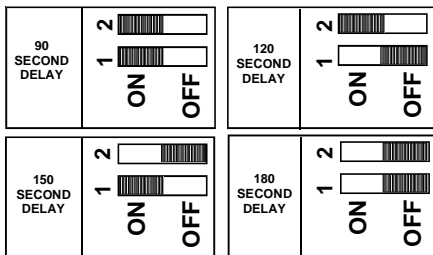

Switches viewed in an upflow installation.

Adjustment Switches - (Not present on all models)

### XIII. OPERATIONAL CHECKS



**WARNING**

**TO AVOID PERSONAL INJURY OR DEATH, DO NOT REMOVE ANY INTERNAL COMPARTMENT COVERS OR ATTEMPT ANY ADJUSTMENT. ELECTRICAL COMPONENTS ARE CONTAINED IN BOTH COMPARTMENTS. CONTACT A QUALIFIED SERVICE AGENT AT ONCE IF AN ABNORMAL FLAME APPEARANCE SHOULD DEVELOP.**

### BURNER FLAME

The burner flames should be inspected with the burner compartment door installed. Flames should be stable, quiet, soft, and blue (dust may cause orange tips but they must not be yellow). Flames should extend directly outward from the burners without curling, floating, or lifting off. Flames must not impinge on the sides of the heat exchanger firing tubes.

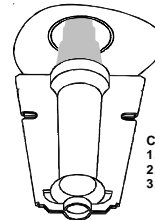

Check the burner flames for:  
 1. Good adjustment  
 2. Stable, soft and blue  
 3. Not curling, floating, or lifting off.

Burner Flame

### AUXILIARY LIMIT CONTROL

Auto reset limits are located on or near the blower. To access this auxiliary limit, disconnect the electrical power and remove the blower door. The auxiliary limit control is designed to prevent furnace operation in case of main blower failure on horizontal and counterflow installations. It may also open if the power supply is interrupted while the furnace is firing. The auxiliary limit control is suitable for both horizontal right and horizontal left installations. Regardless of airflow direction, it does not need to be relocated.



**WARNING**

**TO PREVENT PERSONAL INJURY OR DEATH, DO NOT REMOVE ANY INTERNAL COMPARTMENT COVERS OR ATTEMPT ANY ADJUSTMENT. ELECTRICAL COMPONENTS ARE CONTAINED IN BOTH COMPARTMENTS. CONTACT A QUALIFIED SERVICE AGENT AT ONCE IF AN ABNORMAL FLAME APPEARANCE SHOULD DEVELOP.**

## XIV. SAFETY CIRCUIT DESCRIPTION

### GENERAL

A number of safety circuits are employed to ensure safe and proper furnace operation. These circuits serve to control any potential safety hazards and serve as inputs in the monitoring and diagnosis of abnormal function. These circuits are continuously monitored during furnace operation by the integrated control module.

### INTEGRATED CONTROL MODULE

The integrated control module is an electronic device which controls all furnace operations. Responding to the thermostat, the module initiates and controls normal furnace operation, and monitors and addresses all safety circuits. If a potential safety concern is detected, the module will take the necessary precautions and provide diagnostic information through an LED.

### PRIMARY LIMIT

The primary limit control is located on the partition panel and monitors heat exchanger compartment temperatures. It is an automatic reset, temperature sensor. The limit guards against the overheating resulting from insufficient air passing over the heat exchanger.

### AUXILIARY LIMIT

The auxiliary limit control is located either on or near the circulator blower and monitors heat exchanger compartment temperatures. The control is a temperature sensor. It guards against overheating resulting from insufficient air passing over the heat exchanger.

### ROLLOUT LIMITS

The rollout limit controls are mounted on the burner/manifold assembly and monitor the burner flame. They are manual-reset, temperature sensors. This limit guards against burner flames not being properly drawn into the heat exchanger.

### PRESSURE SWITCHES

The pressure switches are normally-open, negative air pressure-activated switches. They monitor the airflow (combustion air and flue products) through the heat exchanger via pressure taps located on the induced draft blower. These switches guard against insufficient airflow (combustion air and flue products) through the heat exchanger.

### FLAME SENSOR

The flame sensor is a probe mounted to the burner/manifold assembly which uses the principle of flame rectification to determine the presence or absence of flame.

## XV. TROUBLESHOOTING

### ELECTROSTATIC DISCHARGE (ESD) PRECAUTIONS

**NOTE:** Discharge body's static electricity before touching unit. An electrostatic discharge can adversely affect electrical components.

Use the following precautions during furnace installation and servicing to protect the integrated control module from damage. By putting the furnace, the control, and the person at the same electrostatic potential, these steps will help avoid exposing the integrated control module to electrostatic discharge. This procedure is applicable to both installed and uninstalled (ungrounded) furnaces.

1. Disconnect all power to the furnace. Do not touch the integrated control module or any wire connected to the control prior to discharging your body's electrostatic charge to ground.
2. Firmly touch a clean, unpainted, metal surface of the furnace away from the control. Any tools held in a person's hand during grounding will be discharged.
3. Service integrated control module or connecting wiring following the discharge process in step 2. Use caution not to recharge your body with static electricity; (i.e., do not move or shuffle your feet, do not touch ungrounded objects, etc.). If you come in contact with an ungrounded object, repeat step 2 before touching control or wires.
4. Discharge your body to ground before removing a new control from its container. Follow steps 1 through 3 if installing the control on a furnace. Return any old or new controls to their containers before touching any ungrounded object.

### DIAGNOSTIC CHART

Refer to the troubleshooting chart on the following pages for assistance in determining the source of unit operational problems. The red diagnostic LED blinks to assist in troubleshooting the unit. The number of blinks refer to a specific code.

### RESETTING FROM LOCKOUT

Furnace lockout results when a furnace is unable to achieve ignition after three attempts. It is characterized by a non-functioning furnace and a one flash diagnostic LED code from the red LED. If the furnace is in "lockout", it will (or can be) reset in any of the following ways.

1. Automatic reset. The integrated control module will automatically reset itself and attempt to resume normal operations following a one hour lockout period.
2. Manual power interruption. Interrupt 115 volt power to the furnace for 1 - 20 seconds.
3. Manual thermostat cycle. Lower the thermostat so that there is no longer a call for heat for 1 - 20 seconds then reset to previous setting.

**NOTE:** If the condition which originally caused the lockout still exists, the control will return to lockout. Refer to the Diagnostic Chart for aid in determining the cause.

## XVI. MAINTENANCE

### WARNING

**TO AVOID ELECTRICAL SHOCK, INJURY OR DEATH, DISCONNECT ELECTRICAL POWER BEFORE PERFORMING ANY MAINTENANCE. IF YOU MUST HANDLE THE IGNITER, HANDLE WITH CARE. TOUCHING THE IGNITER ELEMENT WITH BARE FINGERS, ROUGH HANDLING, OR VIBRATION COULD DAMAGE THE IGNITER RESULTING IN PREMATURE FAILURE. ONLY A QUALIFIED SERVICER SHOULD EVER HANDLE THE IGNITER.**

### ANNUAL INSPECTION

The furnace should be inspected by a qualified installer, or service agency at least once per year. This check should be performed at the beginning of the heating season. This will ensure that all furnace components are in proper working order and that the heating system functions appropriately. Pay particular attention to the following items. Repair or service as necessary.

- Flue pipe system. Check for blockage and/or leakage. Check the outside termination and the connections at and internal to the furnace.
- Heat exchanger. Check for corrosion and/or buildup within the heat exchanger passageways.
- Burners. Check for proper ignition, burner flame, and flame sense.
- Wiring. Check electrical connections for tightness and/or corrosion. Check wires for damage.
- Filters.

## FILTERS



### WARNING

**TO AVOID PROPERTY DAMAGE, PERSONAL INJURY OR DEATH, DISCONNECT ELECTRICAL POWER BEFORE REMOVING FILTERS. NEVER OPERATE FURNACE WITHOUT A FILTER INSTALLED BECAUSE DUST AND LINT WILL BUILD UP ON INTERNAL PARTS RESULTING IN LOSS OF EFFICIENCY, EQUIPMENT DAMAGE AND POSSIBLE FIRE.**

A return air filter is not supplied with this furnace; however, there must be a means of filtering all of the return air. The installer will supply filter(s) at the time of installation.

## FILTER MAINTENANCE

Improper filter maintenance is the most common cause of inadequate heating or cooling performance. Filters should be cleaned (permanent) or replaced (disposable) every two months or as required. When replacing a filter, it must be replaced with a filter of the same type and size.



### WARNING

**TO PREVENT PROPERTY DAMAGE, PERSONAL INJURY OR DEATH DUE TO ELECTRICAL SHOCK, DISCONNECT ELECTRICAL POWER TO THE FURNACE BEFORE REMOVING THE FILTER OR PERFORMING ANY OTHER MAINTENANCE.**

Become familiar with filter location and procedures for removal, cleaning and replacing them. If help is needed, contact the installer of the furnace or a qualified servicer.

## FILTER REMOVAL

Depending on the installation, differing filter arrangements can be applied. Filters can be installed in either the central return register or a side panel external filter rack (upflow only). A media air filter or electronic air cleaner can be used as an alternate filter. Follow the filter sizes given in the Recommended Minimum Filter size table to ensure proper unit performance.

To remove filters from an external filter rack in an upright upflow installation, follow the directions provided with external filter rack kit. Internal filters are an accessory item and are not included with your furnace. For further details, see your distributor.

## UPRIGHT FILTER REMOVAL

To remove filters from an external filter rack in an upright upflow installation, follow the directions provided with external filter rack kit.

Clean, wash and dry a permanent filter. When using a permanent filter, both sides should be sprayed with a dust adhesive as recommended on the adhesive container. Spray adhesives for use with permanent filters can be found at some hardware stores. **BE SURE AIRFLOW DIRECTION ARROW POINTS TOWARDS THE BLOWER.**

Inspect filter. If your dirty filter is the disposable type, replace dirty filter with the same type and size filter. If your dirty filter is a permanent filter, clean as follows:

- Wash, rinse, and dry the permanent filters. Both sides should then be sprayed with a filter adhesive as is recommended on the adhesive container. Many hardware stores stock spray adhesives for use with permanent filters.
- If badly torn or uncleanable, these filters must be replaced by equal size permanent, high velocity filters. Throwaway filters must not be used as replacement for permanent filters. Under normal use, permanent filters should last for several years.

## INDUCED DRAFT AND CIRCULATOR BLOWER MOTORS

The bearings in the induced draft blower and circulator blower motors are permanently lubricated by the manufacturer. No further lubrication is required. Check motor windings for accumulation of dust which may cause overheating. Clean as necessary.

## FLAME SENSOR (QUALIFIED SERVICER ONLY)

Under some conditions, the fuel or air supply can create a nearly invisible coating on the flame sensor. This coating acts as an insulator causing a drop in the flame sense signal. If the flame sense signal drops too low, the furnace will not sense flame and will lock out. The flame sensor should be carefully cleaned by a qualified servicer using emery cloth or steel wool. Following cleaning, the flame sense signal should be 1 to 6 microamps at 115 volts.

## IGNITER (QUALIFIED SERVICER ONLY)

If the igniter and the surrounding air are at about 70°F and the igniter wires are not connected to any other electrical components, the resistance of the igniter should not exceed 200 ohms. If it does, the igniter should be replaced.

## BURNERS



### WARNING

**TO PREVENT PERSONAL INJURY OR DEATH, DO NOT REMOVE ANY INTERNAL COMPARTMENT COVERS OR ATTEMPT ANY ADJUSTMENT. ELECTRICAL COMPONENTS ARE CONTAINED IN BOTH COMPARTMENTS. CONTACT A QUALIFIED SERVICE AGENT AT ONCE IF AN ABNORMAL FLAME APPEARANCE SHOULD DEVELOP.**

Periodically during the heating season, make a visual check of the burner flames. Turn the furnace on at the thermostat. Wait a few minutes, since any dislodged dust will alter the normal flame appearance. Flames should be stable, quiet, soft and blue with slightly orange tips. They should not be yellow. They should extend directly outward from the burner ports without curling downward, floating or lifting off the ports.

**CLEANING (QUALIFIED SERVICER ONLY)**

1. Shut off electric power and gas supply to the furnace.
2. Disconnect the rollout limit wires, flame sensor wire, and disconnect the igniter plug.

 <b>CAUTION</b>
<b>LABEL ALL WIRES PRIOR TO DISCONNECTION WHEN SERVICING CONTROLS. WIRING ERRORS CAN CAUSE IMPROPER AND DANGEROUS OPERATION. VERIFY PROPER OPERATION AFTER SERVICING.</b>

3. Remove four (4) screws securing the burner box top.

 <b>CAUTION</b>
<b>THE IGNITER IS FRAGILE AND CAN BE EASILY DAMAGED. USE EXTREME CAUTION WHEN REMOVING THE BURNER BOX TOP.</b>

4. Remove the screws securing the burners to the burner bracket. Remove the burners.
5. Use bottle brush to clean burner insert and inside of burner.
6. Replace burner (opposite of removal). Ensure burners are fully seated on burner bracket . Re-connect wiring.

 <b>CAUTION</b>
<b>LABEL ALL WIRES PRIOR TO DISCONNECTION WHEN SERVICING CONTROLS. WIRING ERRORS CAN CAUSE IMPROPER AND DANGEROUS OPERATION. VERIFY PROPER OPERATION AFTER SERVICING.</b>

7. Turn on electric power and gas supply to the furnace.
8. Check furnace for proper operation. Refer to “Operational Checks” section to verify burner flame characteristics.

**XVII. BEFORE LEAVING AN INSTALLATION**

- Cycle the furnace with the thermostat at least three times. Verify cooling and fan only operation.
- Review the Owner’s Manual with the homeowner and discuss proper furnace operation and maintenance.
- Leave literature packet near furnace.



**XVIII. REPAIR AND REPLACEMENT PARTS**

- When ordering any of the listed functional parts, be sure to provide the furnace model, manufacturing, and serial numbers with the order.
- Although only functional parts are shown in the parts list, all sheet metal parts, doors, etc. may be ordered by description.
- Parts are available from your distributor.

Functional Parts List-

Single Stage Gas Valve	Blower/Collector Box Gasket
Natural Gas Orifice	Primary Limit Switch
Propane Gas Orifice	Rollout Limit Switch
Burner	Auxiliary Limit Switch
Hot Surface Igniter	Heat Exchanger
Flame Sensor	Door Switch
Gas Manifold	Transformer
Ignition Control	Blower Wheel
Blower Mounting Bracket	Blower Housing
Pressure Switch	Blower Cutoff
Pressure Switch Hose	Blower Motor
Induced Draft Blower	Motor Mount Bracket
Collector Box	Capacitor





# TROUBLESHOOTING CHART

Symptoms of Abnormal Operation	Associated LED <sup>2</sup>	Fault Description(s)	Possible Causes	Corrective Action	Cautions and Notes
<ul style="list-style-type: none"> <li>Furnace fails to operate.</li> <li>Integrated control module diagnostic LED provides <b>no signal</b>.</li> </ul>	NONE	<ul style="list-style-type: none"> <li>No 115 volt power to furnace, or no 24 volt power to integrated control module.</li> <li>Blown fuse or circuit breaker.</li> </ul>	<ul style="list-style-type: none"> <li>Manual disconnect switch OFF, door switch open, or 24 volt wires improperly connected or loose.</li> <li>Blown fuse or circuit breaker.</li> </ul>	<ul style="list-style-type: none"> <li>Assure 115 and 24 volt power to furnace integrated control module.</li> <li>Check integrated control module fuse (3A). Replace if necessary.</li> <li>Check for possible shorts in 115 and 24 volt circuits. Repair as necessary.</li> </ul>	<ul style="list-style-type: none"> <li>Turn power OFF prior to repair.</li> <li>Replace integrated control module fuse with 3A automotive fuse.</li> </ul>
<ul style="list-style-type: none"> <li>Furnace fails to operate.</li> </ul>		<ul style="list-style-type: none"> <li>Integrated control module has an internal fault.</li> </ul>	<ul style="list-style-type: none"> <li>Integrated control module has an internal fault.</li> </ul>	<ul style="list-style-type: none"> <li>Replace bad integrated control module.</li> </ul>	<ul style="list-style-type: none"> <li>Turn power OFF prior to repair.</li> <li>Read precautions in "Electrostatic Discharge" section of manual.</li> </ul>
<ul style="list-style-type: none"> <li>Furnace fails to operate.</li> <li>Integrated control module diagnostic LED is flashing <b>ONE (1)</b> flash.</li> </ul>	 1 FLASH	<ul style="list-style-type: none"> <li>Furnace lockout due to an excessive number of ignition attempts. (3 total)<sup>1</sup></li> <li>Auxiliary Limit Open</li> </ul>	<ul style="list-style-type: none"> <li>Failure to establish flame. Cause may be no gas to burners, bad igniter or igniter alignment, improper orifices, or coated/oxidized or improperly connected flame sensor.</li> <li>Loss of flame after establishment. Cause may be interrupted gas supply, lazy burner flames (improper gas pressure or restriction in flue or improper induced draft blower performance).</li> <li>Insufficient conditioned air over the heat exchanger. Blocked filters, restrictive ductwork, improper circulator blower speed, or failed circulator blower.</li> </ul>	<ul style="list-style-type: none"> <li>Locate and correct gas interruption.</li> <li>Replace or realign igniter.</li> <li>Check flame sense signal. Sand sensor if coated and/or oxidized.</li> <li>Check flue piping for blockage, proper length, elbows, and termination.</li> <li>Verify proper induced draft blower performance.</li> <li>Check circulator blower speed and performance. Correct speed or replace blower if necessary.</li> </ul>	<ul style="list-style-type: none"> <li>Turn power OFF prior to repair.</li> <li>Igniter is fragile, handle with care.</li> <li>Clean flame sensor with steel wool.</li> <li>See "Combustion and Ventilation Air Requirements" and "Category I Venting (Vertical Venting)" section for details.</li> <li>See Product Data Bulletin for allowable rise range and proper circulator speed.</li> </ul>
<ul style="list-style-type: none"> <li>Furnace fails to operate.</li> <li>Integrated control module diagnostic LED is flashing <b>TWO (2)</b> flashes.</li> </ul>	 2 FLASHES	<ul style="list-style-type: none"> <li>Pressure switch circuit is closed.</li> <li>Induced draft blower <b>is not</b> operating.</li> </ul>	<ul style="list-style-type: none"> <li>Induced draft blower pressure switch contacts sticking.</li> <li>Shorts in pressure switch circuit.</li> </ul>	<ul style="list-style-type: none"> <li>Replace induced draft blower pressure switch.</li> <li>Repair short.</li> </ul>	<ul style="list-style-type: none"> <li>Turn power OFF prior to repair.</li> <li>Replace pressure switch with proper replacement part.</li> </ul>
<ul style="list-style-type: none"> <li>Induced draft blower runs continuously with no further furnace operation.</li> <li>Integrated control module diagnostic LED is flashing <b>THREE (3)</b> flashes.</li> </ul>	 3 FLASHES	<ul style="list-style-type: none"> <li>Pressure switch circuit not closed.</li> <li>Induced draft blower <b>is</b> operating.</li> </ul>	<ul style="list-style-type: none"> <li>Pressure switch hose blocked, pinched or connected improperly.</li> <li>Blocked flue or weak induced draft blower.</li> <li>Incorrect pressure switch setpoint or malfunctioning switch contacts.</li> <li>Loose or improperly connected wiring.</li> </ul>	<ul style="list-style-type: none"> <li>Inspect pressure switch hose. Repair, if necessary,</li> <li>Inspect flue for blockage, proper length, elbows, and termination.</li> <li>Correct pressure switch setpoint or contact motion.</li> <li>Tighten or correct wiring connection.</li> </ul>	<ul style="list-style-type: none"> <li>Turn power OFF prior to repair.</li> <li>See "Combustion and Ventilation Air Requirements" and "Category I Venting (Vertical Venting)" section for details.</li> <li>Replace pressure switch with proper replacement part.</li> </ul>

<sup>1</sup> Integrated control module will automatically attempt to reset from lockout after one hour.

<sup>2</sup> LED Flash code will cease if power to the control module is interrupted through the disconnect or door switch.

# TROUBLESHOOTING CHART

Symptoms of Abnormal Operation	Associated LED <sup>2</sup>	Fault Description(s)	Possible Causes	Corrective Action	Cautions and Notes
<ul style="list-style-type: none"> <li>• Circulator blower runs continuously. No furnace operation.</li> <li>• Integrated control module diagnostic LED is flashing <b>FOUR (4)</b> flashes.</li> </ul>	 4 FLASHES	<ul style="list-style-type: none"> <li>• Primary limit circuit is open.</li> </ul>	<ul style="list-style-type: none"> <li>• Faulty primary limit switch.</li> <li>• Insufficient conditioned air over the heat exchanger. Blocked filters, restrictive ductwork, improper circulator blower speed, or failed circulator blower.</li> <li>• Loose or improperly connected wiring.</li> </ul>	<ul style="list-style-type: none"> <li>• Check primary limit. Replace if necessary.</li> <li>• Check filters and ductwork for blockage. Clean filters or remove obstruction.</li> <li>• Check circulator blower speed and performance. Correct speed or replace blower if necessary.</li> <li>• Tighten or correct wiring connection.</li> </ul>	<ul style="list-style-type: none"> <li>• Turn power OFF prior to repair.</li> <li>• Replace primary limit with proper replacement part.</li> <li>• Replace blower with correct replacement part.</li> </ul>
<ul style="list-style-type: none"> <li>• Induced draft blower and circulator blower runs continuously. No furnace operation.</li> <li>• Integrated control module diagnostic LED is flashing <b>FIVE (5)</b> flashes.</li> </ul>	 5 FLASHES	<ul style="list-style-type: none"> <li>• Flame sensed with no call for heat.</li> </ul>	<ul style="list-style-type: none"> <li>• Short to ground in flame sense circuit.</li> </ul>	<ul style="list-style-type: none"> <li>• Correct short at flame sensor or in flame sensor wiring</li> </ul>	<ul style="list-style-type: none"> <li>• Turn power OFF prior to repair.</li> </ul>
<ul style="list-style-type: none"> <li>• Furnace fails to operate.</li> <li>• Integrated control module diagnostic LED is flashing <b>SIX (6)</b> flashes.</li> </ul>	 6 FLASHES	<ul style="list-style-type: none"> <li>• Rollout limit open.</li> </ul>	<ul style="list-style-type: none"> <li>• Flame rollout.</li> <li>• Misaligned burners, blocked flue or failed induced draft blower.</li> <li>• Loose or improperly connected wiring.</li> <li>• Faulty rollout limit.</li> </ul>	<ul style="list-style-type: none"> <li>• Check burners for proper alignment.</li> <li>• Check flue and air inlet piping for blockage, proper length, elbows, and termination. Correct as necessary.</li> <li>• Check rollout limit. Replace if necessary.</li> <li>• Check induced draft blower for proper performance. Replace, if necessary.</li> <li>• Tighten or correct wiring connection.</li> </ul>	<ul style="list-style-type: none"> <li>• See "Vent/Flue Pipe" section for piping details.</li> <li>• Replace induced draft blower with proper replacement part.</li> <li>• Replace rollout limit with correct replacement part.</li> </ul>
<ul style="list-style-type: none"> <li>• Normal furnace operation.</li> <li>• Integrated control module diagnostic LED is flashing <b>SEVEN (7)</b> flashes.</li> </ul>	 7 FLASHES	<ul style="list-style-type: none"> <li>• Flame sense microamp signal is low.</li> </ul>	<ul style="list-style-type: none"> <li>• Flame sensor is coated/oxidized.</li> <li>• Flame sensor incorrectly positioned in burner flame.</li> <li>• Lazy burner flame due to improper gas pressure or combustion air.</li> </ul>	<ul style="list-style-type: none"> <li>• Sand flame sensor.</li> <li>• Inspect for proper sensor alignment.</li> <li>• Compare current gas pressure to rating plate info. Adjust as needed.</li> </ul>	<ul style="list-style-type: none"> <li>• Turn power OFF prior to repair.</li> <li>• Clean flame sensor with steel wool.</li> <li>• See "Vent/Flue Pipe" section for piping details.</li> <li>• See rating plate for proper gas pressure.</li> </ul>
<ul style="list-style-type: none"> <li>• Induced draft blower runs continuously. No furnace operation.</li> <li>• Integrated control module diagnostic LED is flashing <b>continuously</b>.</li> </ul>	 CONTINUOUS FLASHING	<ul style="list-style-type: none"> <li>• Polarity of 115 or 24 volt power is reversed.</li> </ul>	<ul style="list-style-type: none"> <li>• Polarity of 115 volt AC power to furnace or integrated control module is reversed.</li> <li>• Red and blue wires to transformer are reversed.</li> <li>• Poor unit ground.</li> </ul>	<ul style="list-style-type: none"> <li>• Review wiring diagram to correct polarity.</li> <li>• Verify proper ground. Correct if necessary.</li> <li>• Reverse red and blue wires connected to transformer.</li> </ul>	<ul style="list-style-type: none"> <li>• Turn power OFF prior to repair.</li> </ul>
<ul style="list-style-type: none"> <li>• LED is steady on</li> </ul>	STEADY ON	<ul style="list-style-type: none"> <li>• Normal operation.</li> </ul>			

<sup>2</sup> LED Flash code will cease if power to the control module is interrupted through the disconnect or door switch.

# WIRING DIAGRAM FOR GMS8/GHS8/GDS8

**WARNING-DISCONNECT POWER BEFORE SERVICING.** WIRING TO UNIT MUST BE PROPERLY POLARIZED AND GROUNDED.

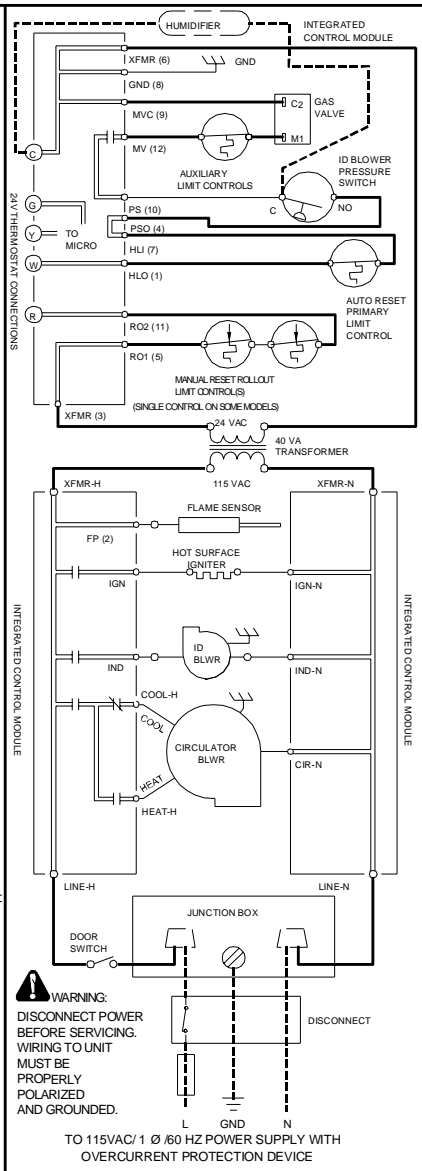
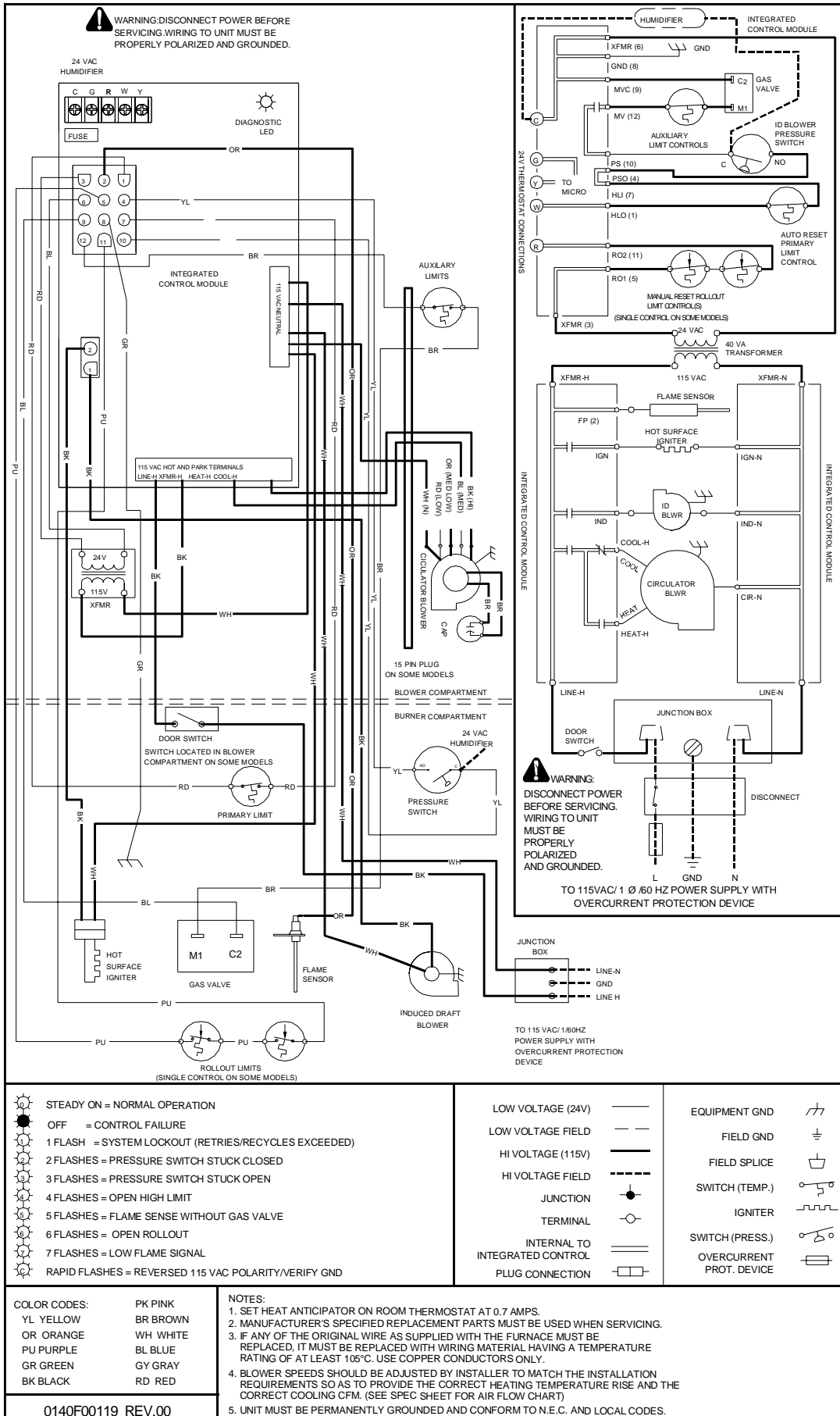

**WARNING:** DISCONNECT POWER BEFORE SERVICING. WIRING TO UNIT MUST BE PROPERLY POLARIZED AND GROUNDED.

TO 115VAC/1 Ø 60 HZ POWER SUPPLY WITH OVERCURRENT PROTECTION DEVICE

**TO AVOID POSSIBLE ELECTRICAL SHOCK, PERSONAL INJURY, OR DEATH, DISCONNECT THE POWER BEFORE SERVICING.**



<ul style="list-style-type: none"> <li>● STEADY ON = NORMAL OPERATION</li> <li>● OFF = CONTROL FAILURE</li> <li>1 FLASH = SYSTEM LOCKOUT (RETRIES/RECYCLES EXCEEDED)</li> <li>2 FLASHES = PRESSURE SWITCH STUCK CLOSED</li> <li>3 FLASHES = PRESSURE SWITCH STUCK OPEN</li> <li>4 FLASHES = OPEN HIGH LIMIT</li> <li>5 FLASHES = FLAME SENSE WITHOUT GAS VALVE</li> <li>6 FLASHES = OPEN ROLLOUT</li> <li>7 FLASHES = LOW FLAME SIGNAL</li> <li>● RAPID FLASHES = REVERSED 115 VAC POLARITY/VERIFY GND</li> </ul>	<p>LOW VOLTAGE (24V) ———</p> <p>LOW VOLTAGE FIELD ———</p> <p>HI VOLTAGE (115V) ———</p> <p>HI VOLTAGE FIELD ———</p> <p>JUNCTION ●</p> <p>TERMINAL ○</p> <p>INTERNAL TO INTEGRATED CONTROL ———</p> <p>PLUG CONNECTION ———</p>	<p>EQUIPMENT GND ⚡</p> <p>FIELD GND ⊕</p> <p>FIELD SPLICE ⚡</p> <p>SWITCH (TEMP.) ⚡</p> <p>IGNITER ⚡</p> <p>SWITCH (PRESS.) ⚡</p> <p>OVERCURRENT PROT. DEVICE ⚡</p>
---	---	---

- COLOR CODES:**
- |           |          |
|-----------|----------|
| YL YELLOW | BR BROWN |
| OR ORANGE | WH WHITE |
| PU PURPLE | BL BLUE  |
| GR GREEN  | GY GRAY  |
| BK BLACK  | RD RED   |
- NOTES:**
- SET HEAT ANTICIPATOR ON ROOM THERMOSTAT AT 0.7 AMPS.
  - MANUFACTURER'S SPECIFIED REPLACEMENT PARTS MUST BE USED WHEN SERVICING.
  - IF ANY OF THE ORIGINAL WIRE AS SUPPLIED WITH THE FURNACE MUST BE REPLACED, IT MUST BE REPLACED WITH WIRING MATERIAL HAVING A TEMPERATURE RATING OF AT LEAST 105°C. USE COPPER CONDUCTORS ONLY.
  - BLOWER SPEEDS SHOULD BE ADJUSTED BY INSTALLER TO MATCH THE INSTALLATION REQUIREMENTS SO AS TO PROVIDE THE CORRECT HEATING TEMPERATURE RISE AND THE CORRECT COOLING CFM. (SEE SPEC SHEET FOR AIR FLOW CHART)
  - UNIT MUST BE PERMANENTLY GROUNDED AND CONFORM TO N.E.C. AND LOCAL CODES.

0140F00119 REV.00

Wiring is subject to change. Always refer to the wiring diagram on the unit for the most up-to-date wiring.

**NOTE: SPECIFICATIONS AND PERFORMANCE DATA LISTED HEREIN  
ARE SUBJECT TO CHANGE WITHOUT NOTICE**

**Quality Makes the Difference!**

All of our systems are designed and manufactured with the same high quality standards regardless of size or efficiency. We have designed these units to significantly reduce the most frequent causes of product failure. They are simple to service and forgiving to operate. We use quality materials and components. Finally, every unit is run tested before it leaves the factory. That's why we know. . . **There's No Better Quality.**

Visit our website at [www.goodmanmfg.com](http://www.goodmanmfg.com) or [www.amana-hac.com](http://www.amana-hac.com) for information on:

- Products
- Warranties
- Customer Services
- Parts
- Contractor Programs and Training
- Financing Options

Goodman Manufacturing Company, L.P.  
2550 North Loop West, Suite 400, Houston, TX 77092

[www.goodmanmfg.com](http://www.goodmanmfg.com)

© 2006 Goodman Manufacturing Company, L.P.