

# HASFK-6

## HIGH ALTITUDE CONVERSION KIT(S)

### INSTALLATION INSTRUCTIONS

#### ATTENTION INSTALLING PERSONNEL

As a professional installer you have an obligation to know the product better than the customer. This includes all safety precautions and related items.

Prior to actual installation, thoroughly familiarize yourself with this Instruction Manual. Pay special attention to all safety warnings. Often during installation or repair it is possible to place yourself in a position which is more hazardous than when the unit is in operation.

Remember, it is **your** responsibility to install the product safely and to know it well enough to be able to instruct a customer in its safe use. Safety is a matter of common sense...a matter of thinking before acting. Most dealers have a list of specific good safety practices...follow them.

The precautions listed in this Installation Manual are intended as supplemental to existing practices. However, if there is a direct conflict between existing practices and the content of this manual, the precautions listed here take precedence.



**RECOGNIZE THIS SYMBOL  
AS A SAFETY PRECAUTION**

#### DESCRIPTION

This kit contains the appropriate burner orifices, and pressure switch for the application of 90% furnaces in installations above their maximum (as shipped) rated altitudes. This kit is not applicable in Canada. Parts apply as shown in the table below.

Above 7,000 Feet		
Natural Gas Orifices	Propane Gas Orifices	Pressure Switch
B2589907 (#49)	B2589908 (#56)	0130F00493 (-.90)

Table 1

Above an altitude of 7,000 feet, a derating of the appliance must be followed since the CFM moved by the induced draft blower remains almost constant while the pounds of oxygen in that air is reduced as altitude increases. If this procedure is not followed and the fuel input is not reduced the resulting combustion can be inefficient, incomplete, or possibly cause premature heat exchanger failure due to excessive temperature rise. The burner orifices in the high altitude kits have been selected as a result of agency certified testing at high altitude and will provide the appropriate derate. Orifice selection is based on non-derated gas [at standard conditions of 29.92 in Hg and 60°F—approximately 1,000 Btu/ft<sup>3</sup> for natural gas and 2,500 Btu/ft<sup>3</sup> for propane]. If the Btu content of your gas supply has been artificially changed to account for altitude, contact your gas supplier for orifice sizing (orifice may not require change).

Do not derate by adjusting the manifold pressure to a lower pressure setting than specified on the furnace nameplate. A lower air density in combination with a lower manifold pressure at the burner orifice will prevent the orifice from aspirating the proper amount of air into the burner required for complete combustion.

In addition to using smaller orifices to reduce the fuel input, a different pressure switch must be used above the maximum (as shipped) rated altitude. A high altitude pressure switch is necessary as a result of the reduction in air density and is required regardless of the Btu content of the fuel used.

Altitude (ft.)	Burner Orifice Size	
	Natural	Propane
0 - 7,000	#45	1.25mm
Above 7,000	#49	#56



Table 2

#### CONTENTS

ATTENTION INSTALLING PERSONNEL .....	1
DESCRIPTION .....	1
IMPORTANT INFORMATION .....	2
HASFK-6 .....	2
Orifice and Pressure Switch Assembly Installation .....	2
Adjustments and Checks .....	4
Manifold Pressure Check .....	5
Inspect Burner Flame .....	6
Check and Adjust Unit Temperature Rise .....	6





## IMPORTANT INFORMATION

 <b>WARNING</b>	
<b>HIGH VOLTAGE</b> DISCONNECT ALL ELECTRICAL POWER AND SHUT OFF GAS SUPPLY BEFORE SERVICING OR INSTALLING. MULTIPLE POWER SOURCES MAY BE PRESENT. FAILURE TO DO SO MAY CAUSE PROPERTY DAMAGE, PERSONAL INJURY OR DEATH.	

 <b>WARNING</b>
<b>IF THE GAS FURNACE IS INSTALLED IN A BASEMENT, AN EXCAVATED AREA OR A CONFINED SPACE, IT IS STRONGLY RECOMMENDED TO CONTACT A PROPANE SUPPLIER TO INSTALL A GAS DETECTING WARNING DEVICE IN CASE OF A GAS LEAK.</b> • SINCE PROPANE GAS IS HEAVIER THAN AIR, ANY LEAKING GAS CAN SETTLE IN ANY LOW AREAS OR CONFINED SPACES. • PROPANE GAS ODORANT MAY FADE, MAKING THE GAS UNDETECTABLE EXCEPT WITH A WARNING DEVICE.

 <b>WARNING</b>
<b>IF THE INFORMATION IN THESE INSTRUCTIONS IS NOT FOLLOWED EXACTLY, A FIRE OR EXPLOSION MAY RESULT CAUSING PROPERTY DAMAGE, PERSONAL INJURY OR LOSS OF LIFE.</b>  – DO NOT STORE OR USE GASOLINE OR OTHER FLAMMABLE VAPORS AND LIQUIDS IN THE VICINITY OF THIS OR ANY OTHER APPLIANCE.  – <b>WHAT TO DO IF YOU SMELL GAS:</b> • DO NOT TRY TO LIGHT ANY APPLIANCE. • DO NOT TOUCH ANY ELECTRICAL SWITCH; DO NOT USE ANY PHONE IN YOUR BUILDING. • IMMEDIATELY CALL YOUR GAS SUPPLIER FROM A NEIGHBOR'S PHONE. FOLLOW THE GAS SUPPLIER'S INSTRUCTIONS. • IF YOU CANNOT REACH YOUR GAS SUPPLIER, CALL THE FIRE DEPARTMENT. – INSTALLATION AND SERVICE MUST BE PERFORMED BY A QUALIFIED INSTALLER, SERVICE AGENCY OR THE GAS SUPPLIER.

 <b>WARNING</b>
<b>PERSONAL INJURY OR DEATH MAY RESULT FROM IMPROPER INSTALLATION OR MAINTENANCE PERFORMED BY UNTRAINED PERSONNAL. CALL YOUR INSTALLING DEALER OR OTHER QUALIFIED SERVICE COMPANIES TO PERFORM THE INSTALLATION OR MAINTENANCE INSPECTION.</b>

 <b>WARNING</b>
<b>TO AVOID PROPERTY DAMAGE, PERSONAL INJURY OR DEATH DUE TO EXPLOSION OR FIRE, INSTALL A GAS DETECTING WARNING DEVICE. SINCE THE ODORANT IN PROPANE GAS CAN BE REDUCED BY IRON OXIDE (RUST), A GAS DETECTING WARNING DEVICE IS THE ONLY RELIABLE METHOD TO DETECT PROPANE GAS LEAKS.</b>

*Contact a local propane gas supplier*

*about installing a gas detecting warning device.*

**NOTE:** To ensure proper operation, install, operate and maintain the unit in accordance with these installation instructions, all local building codes and ordinances. In their absence, follow the latest edition of the National Fuel Gas Code (NFPA 54/ANSI Z223.1), and/or CAN/CSA B149.1 Installation Codes.

### HASFK-6

The conversion from "standard altitude" natural gas orifices and pressure switch assembly (as shipped from the factory) to "high altitude" natural or propane orifices and pressure switch assembly requires the following tools and supplies:

- 1 - 7/16" box wrench
- 1 - 1/4" nut driver
- 1 - 3/16" allen wrench
- 1 - 1/4" flat blade screwdriver
- 1 - Manometer to read inlet and outlet pressure of the gas valve (minimum range: 0" - 20" W.C.)
- Gas leak detection solution like soap and water solution. Always wipe the solution from the joints when testing is completed.

Before proceeding, shut OFF gas supply at manual shut-off and turn off power to the unit.

### ORIFICE AND PRESSURE SWITCH ASSEMBLY INSTALLATION

 <b>CAUTION</b>
<b>TO AVOID THE RISK OF PROPERTY DAMAGE, PERSONAL INJURY OR FIRE, SHUT OFF GAS SUPPLY FIRST, THEN DISCONNECT THE ELECTRICAL SUPPLY BEFORE PROCEEDING WITH CONVERSION.</b>

1. Shut OFF gas supply at manual shutoff and turn OFF power to the unit.
2. Remove access door.
3. Disconnect wiring from the gas valve.

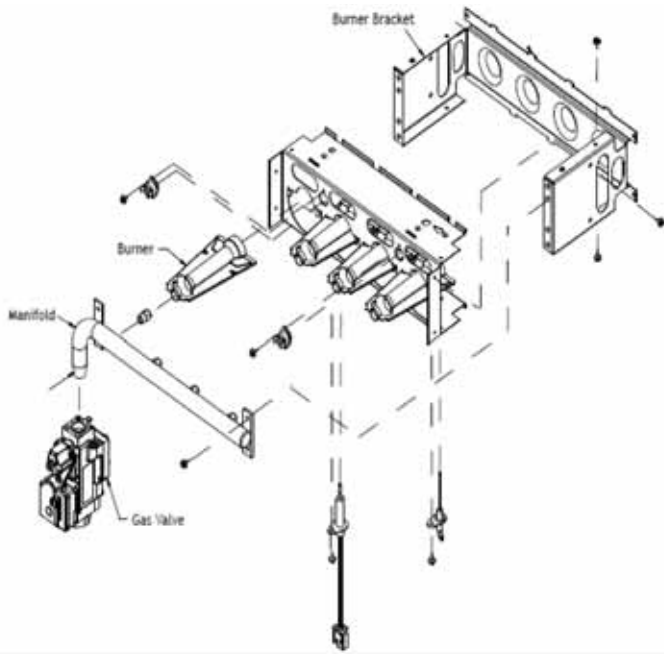

**Figure 1**  
**Gas Manifold Removal**

4. Remove the screws securing the gas manifold and valve to the burner bracket and retain. Separate gas manifold and valve from burner bracket.

**NOTE:** If Natural Gas conversion proceed to step 5 and upon completion of step 5 skip to step 9.

If Propane Gas conversion skip step 5 and jump to step 6 PROPANE GAS BURNER ORIFICE and GAS VALVES SPRING REPLACEMENT step.

5. NATURAL GAS BURNER ORIFICE REPLACEMENT

- a. Remove **standard** altitude natural gas orifices from gas manifold using a box end wrench.
- b. Visually inspect Natural gas high altitude orifices (B2589907) for damage and drill size (marked on face with #49) before installation. Using 7/16" box-end wrench, remove all existing #45 natural gas orifices and replace with the appropriate #49 natural gas **high altitude** orifices supplied in the kit. Tighten orifices with a box-end wrench; do not cross-thread or overtighten. Orifice usage depends on an installation's gas usage and altitude.

6. PROPANE GAS BURNER ORIFICE AND GAS VALVES SPRING REPLACEMENT

**IMPORTANT: propane gas is heavier than air and does not vent upward as natural gas fuels.**

Single Stage Models

- a. Remove **standard** altitude natural gas orifices from gas manifold using a box end wrench.
- b. Visually inspect Propane gas high altitude orifices (B2589908) for damage and drill size (marked on face

with #56) before installation. Using 7/16" box-end wrench, remove all existing #45 natural gas orifices and replace with the appropriate #56 propane gas **high altitude** orifices supplied in the kit. Tighten orifices with a box-end wrench; do not cross-thread or overtighten. Orifice usage depends on an installation's gas usage and altitude.

- c. Remove regulator cover screw from gas valve.
- d. Using a 1/4" flat blade screwdriver, remove regulator adjustment screw (beneath the cover screw),
- e. Remove Natural gas regulator spring (color-coded silver/plain) from regulator sleeve and retain with the Natural Gas orifices for future reconversion.
- f. Insert the L.P. regulator spring [provided in the conversion kit (B1880007) and color-coded white] into the regulator sleeve.

Hybrid Models

- a. Remove **standard** altitude natural gas orifices from gas manifold using a box end wrench.
- b. Visually inspect Propane gas high altitude orifices (B2589908) for damage and drill size (marked on face with #56) before installation. Using 7/16" box-end wrench, remove all existing #45 natural gas orifices and replace with the appropriate #56 propane. Tighten orifices with a box-end wrench; do not cross-thread or overtighten. Orifice usage depends on an installation's gas usage and altitude.
- c. Remove both regulator cover screws from gas valve.
- d. Using a 1/4" flat blade screwdriver, remove both regulator adjustment screws (beneath the cover screw),
- e. Remove both Natural gas regulator springs (color-coded silver/plain) from regulator sleeves and retain with the Natural Gas orifices for future reconversion.
- f. Insert the L.P. regulator springs [provided in the conversion kit (0163F00000P) and color-coded white] into the regulator sleeves.

**NOTE:** For hybrid models, the control board dip switches need to be set to 2 stg position to set and verify first stage heat. (See installation instructions supplied with the unit for dip switch settings)

7. Replace the High regulator adjustment screw and adjust it clockwise to bottom stop. Then follow the instructions in the Manifold Pressure Check section to set appropriate manifold pressures as shown in:

Table 4 for Single Stage Models or  
Table 6 for Hybrid Stage Models

8. Replace the Low regulator adjustment screw and adjust it clockwise to bottom stop. Then follow the instructions in the Manifold Pressure Check section to set appropriate manifold pressures as shown in Table 6.

9. PRESSURE SWITCH ASSEMBLY INSTALLATION

- a. Locate pressure switch assembly located on the induced draft blower.

**NOTE:** Front Cover pressure switch with two gray wires does not require a change.

- b. Disconnect the pressure switch hose from the pressure switch assembly tee.
- c. Disconnect (yellow and orange) wiring from ID Blower pressure switch.
- d. Remove screw securing standard altitude ID Blower pressure switch to switch assembly.
- e. Install high altitude ID Blower pressure switch 0130F00493 using screw removed in Step 9d.
- f. Reconnect wiring to pressure switch assembly.
- g. Reconnect pressure switch hose to new assembly.

 <b>WARNING</b>
<b>TO AVOID THE POSSIBILITY OF EXPLOSION OR FIRE, NEVER USE A MATCH OR OPEN FLAME TO TEST FOR LEAKS.</b>

 <b>CAUTION</b>
<b>TO AVOID PERSONAL INJURY OR PROPERTY DAMAGE DUE TO FIRE, MAKE CERTAIN ALL WIRES DISCONNECTED FROM THE PRESSURE SWITCH DURING THIS PROCEDURE ARE PROPERLY RECONNECTED.</b>

**Hybrid 2-Stage Valve**

1. Connect a calibrated water manometer or appropriate gas pressure gauge at either the gas valve **inlet** pressure tap or gas piping drip leg. The gas supply and manifold pressure on White-Rodgers 36J54 gas valves, can be checked with a gas pressure test kit (Part # 0151K00000S) available in this kit.
2. Turn ON the power and gas, put the unit into heating cycle and turn on all other gas consuming appliances.
3. Leak check burner orifice threads using soap solution.
4. Measure the gas supply pressure with the burners firing. The inlet gas pressure for natural gas should be between **5.0 and 10.0 inches W.C.** The inlet gas pressure for propane gas must be between **11.0 and 13.0 inches W.C.** If supply pressure differs from required, make necessary adjustments to pressure regulator(s), gas piping, etc.
5. Turn OFF gas to the unit at the manual shutoff valve and disconnect manometer. Reinstall line pressure tap plug. Turn OFF any unnecessary appliances started in step 2.

**Single Stage Valve**

1. Connect a calibrated water manometer or appropriate gas pressure gauge at either the gas valve **inlet** pressure tap or gas piping drip leg. The gas supply and manifold pressure on White-Rodgers 36J22 gas valves, can be checked with a gas pressure test kit (Part # 0151K00000S) available in this kit.
2. Turn ON the power and gas, put the unit into heating cycle and turn on all other gas consuming appliances.
3. Leak check burner orifice threads using soap solution.
4. Measure the gas supply pressure with the burners firing. The inlet gas pressure for natural gas should be between **5.0 and 10.0 inches W.C.** The inlet gas pressure for propane gas must be between **11.0 and 13.0 inches W.C.** If supply pressure differs from required, make necessary adjustments to pressure regulator(s), gas piping, etc.
5. Turn OFF gas to the unit at the manual shutoff valve and disconnect manometer. Reinstall line pressure tap plug. Turn OFF any unnecessary appliances started in step 2.

**Figure 2**  
**(Upflow shown, counterflow similar)**

**ADJUSTMENTS AND CHECKS**

The following adjustments and checks are a required part of this conversion. Adjustment and checks include:

- Leak checking orifices.
- Checking and adjusting line and manifold gas pressures.
- Verifying proper unit operation (input rate, operational sequence, burner flame, temperature rise, etc.).

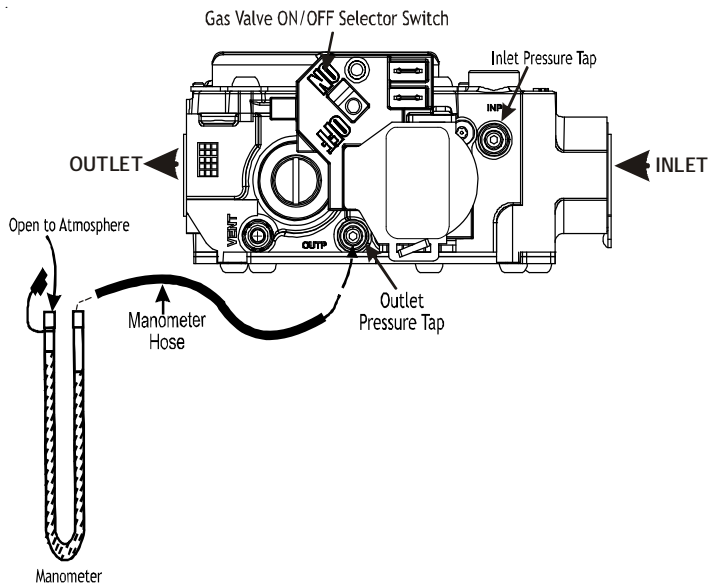

Figure 3

White-Rodgers Model 36J22 Connected to Manometer

Natural Gas Manifold Pressure	
Low Stage	High Stage
1.6 to 2.2" w.c.	3.2 to 3.8" w.c.

Table 5

Propane Gas Manifold Pressure	
Low Stage	High Stage
5.7 to 6.3" w.c.	9.7 to 10.3" w.c.

Table 6

### Hybrid 2-Stage Valve

1. Turn OFF gas to the unit at the manual gas shutoff valve.
2. Connect a calibrated water manometer or appropriate gas pressure gauge at the gas valve **outlet** pressure tap. The gas supply and manifold pressure on White-Rodgers 36J54 gas valves, can be checked with a gas pressure test kit (Part # 0151K00000S) available in this kit.
3. Turn ON gas supply and operate unit.
4. Remove the cap screw from the manifold pressure regulator adjustment location.
5. Using an Allen wrench, adjust *high stage* manifold regulator (clock wise to increase, counter clock wise to decrease) to the required manifold pressure (Table 5 for Natural Gas or Table 6 for Propane Gas).
6. Reinstall the *high stage* manifold pressure regulator cap screw. Confirm *high stage* manifold pressure.
7. Remove the cap screw from the *low stage* manifold pressure regulator adjustment location.
8. Using an Allen wrench, adjust *low stage* manifold regulator (clock wise to increase, counter clock wise to decrease) to the required manifold pressure.
9. Reinstall the *low stage* manifold regulator cap screw. Confirm *low stage* manifold pressure.
10. Turn OFF gas supply to unit. Disconnect manometer and reinstall manifold pressure tap plug.

### Single Stage Valve

1. Turn OFF gas to the unit at the manual gas shutoff valve.
2. Connect a calibrated water manometer or appropriate gas pressure gauge at the gas valve **outlet** pressure tap. The gas supply and manifold pressure on White-Rodgers 36J22 gas valves, can be checked with a gas pressure test kit (Part #0151K00000S) available in this kit.
3. Turn ON gas supply and operate unit.
4. Remove the cap screw from the manifold pressure regulator adjustment location.
5. Using an Allen wrench, adjust manifold regulator (clockwise to increase, counter clock wise to decrease) to the required manifold pressure (Table 3 for Natural Gas or Table 4 for Propane Gas).

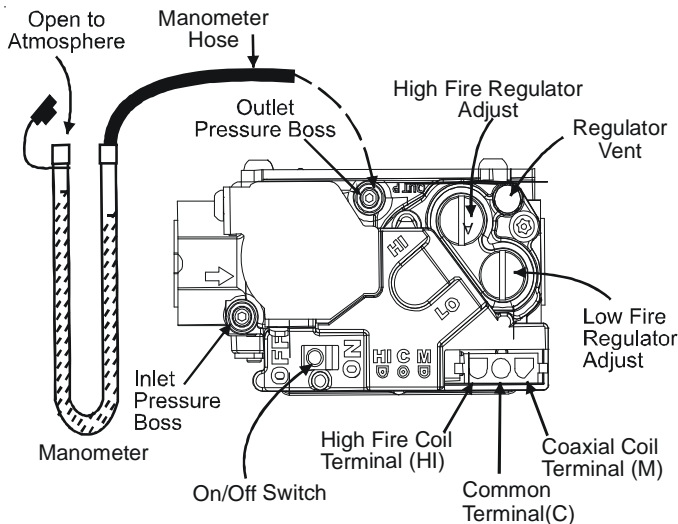

Figure 4

White-Rodgers Model 36J54 Connected to Manometer

### MANIFOLD PRESSURE CHECK

Only small variations in gas flow should be made by adjusting the gas valve pressure regulator. See Table 3 or 5 for the required natural gas manifold pressure and see Table 4 or 6 for the required propane gas manifold pressure.

Natural Gas Manifold Pressure
Single Stage
3.2 to 3.8" w.c.

Table 3

Propane Gas Manifold Pressure
Single Stage
9.7 to 10.3" w.c.

Table 4

6. Reinstall the manifold pressure regulator cap screw. Confirm manifold pressure.
7. Turn OFF gas supply to unit. Disconnect manometer and reinstall manifold pressure tap plug.

### **INSPECT BURNER FLAME**

The burner flames should be stable, soft and blue (dust may cause orange tips but they must not be yellow). They should extend directly outward from the burners without curling, floating, or lifting off.

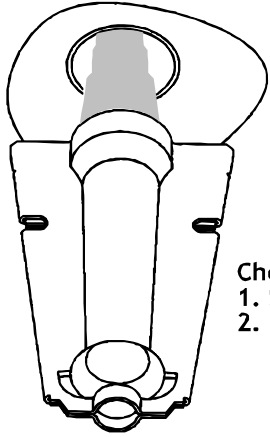

- Check the burner flames for:**
- 1. Stable, soft and blue**
  - 2. Not curling, floating, or lifting off.**

**Figure 5**  
**Burner Flame**

### **CHECK AND ADJUST UNIT TEMPERATURE RISE**

Check and adjust unit temperature rise(s) as described in the installation manual.

Temperature rise must be within the range shown on the furnace rating plate.

THIS PAGE INTENTIONALLY LEFT BLANK.

**NOTE: SPECIFICATIONS AND PERFORMANCE DATA LISTED HEREIN ARE SUBJECT TO CHANGE WITHOUT NOTICE**

### **Quality Makes the Difference!**

All of our systems are designed and manufactured with the same high quality standards regardless of size or efficiency. We have designed these units to significantly reduce the most frequent causes of product failure. They are simple to service and forgiving to operate. We use quality materials and components. Finally, every unit is run tested before it leaves the factory. That's why we know. . . **There's No Better Quality.**

Visit our website at [www.daikincomfort.com](http://www.daikincomfort.com), [www.goodmanmfg.com](http://www.goodmanmfg.com) or [www.amana-hac.com](http://www.amana-hac.com) for information on:

- Products
- Warranties
- Customer Services
- Parts
- Contractor Program and Training
- Financing Options

© 2015 Goodman Manufacturing Company, L.P.

**Amana** is a registered trademark of Maytag Corporation or its related companies and is used under license. All rights reserved.