



**BLUERIDGE**



# ***Owner's Manual***

**Original Instructions**

Split Air Conditioner



Model:

BXS4Z24WM0

Thank you for choosing our product.  
Please read this Owner's Manual carefully before operation and retain it for future reference.  
If you have lost the Owner's Manual, please contact the local agent at 800-865-5931 or visit [www.alpinehomeair.com](http://www.alpinehomeair.com).

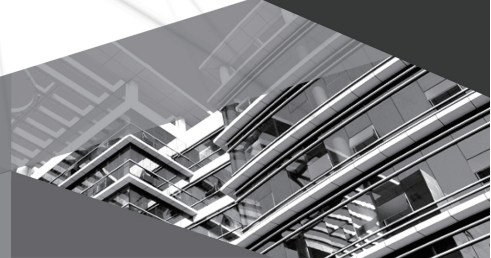

# CONTENTS

---

Safety precautions .....	01
Parts name .....	07
Operation and introduction of remote controller .....	08
Clean and maintenance .....	15
Checked items before maintenance .....	16
Installation notice .....	17
Installation of indoor unit .....	19
Test and operation .....	22
Specialist's Manual .....	24

---

## ■ Explanation of Symbols

### **WARNING**

This symbol indicates the possibility of death or serious injury.

### **CAUTION**

This symbol indicates the possibility of injury or damage to property.

### **NOTICE**

Indicates important but not hazard-related information, used to indicate risk of property damage.





## ■ Exception Clauses

Manufacturer will bear no responsibilities when personal injury or property loss is caused by the following reasons.

1. Damage the product due to improper use or misuse of the product;
2. Alter, change, maintain or use the product with other equipment without abiding by the instruction manual of manufacturer;
3. After verification, the defect of product is directly caused by corrosive gas;
4. After verification, the defects are due to improper operation during transportation of product;
5. Operate, repair, maintain the unit without abiding by instruction manual or related regulations;
6. After verification, the problem or dispute is caused by the quality specification or performance of parts and components that produced by other manufacturers;
7. The damage is caused by natural calamities, bad using environment or force majeure.

- If it needs to install, move or maintain the air conditioner, please contact dealer or local service center to conduct it at first. Air conditioner must be installed, moved or maintained by appointed unit. Otherwise, it may cause serious damage or personal injury or death.
- When refrigerant leaks or requires discharge during installation, maintenance, or disassembly, it should be handled by certified professionals or otherwise in compliance with local laws and regulations.
- This appliance is not intended for use by persons (including children) with reduced physical, sensory or mental capabilities or lack of experience and knowledge, unless they have been given supervision or instruction concerning use of the appliance by a person responsible for their safety.  
Children should be supervised to ensure that they do not play with the appliance.
- This appliance incorporates an earth connection for functional purposes only.  
Note: Only for models with ground wire from PCB.

## The refrigerant

 <p>Refrigerant Safety Group <b>A2L</b></p> <p>Appliance filled with flammable gas R32.</p>	 <p>Before install the appliance, read the installation manual first.</p>
 <p>Before use the appliance, read the owner's manual first.</p>	 <p>Before repair the appliance, read the service manual first.</p>

- To realize the function of the air conditioner unit, a special refrigerant circulates in the system. The used refrigerant is the fluoride R32, which is specially cleaned. The refrigerant is flammable and inodorous. Furthermore, it can lead to explosion under certain conditions. But the flammability of the refrigerant is very low. It can be ignited only by fire.
- Compared to common refrigerants, R32 is a nonpolluting refrigerant with no harm to the ozoneosphere. The influence upon the greenhouse effect is also lower. R32 has got very good thermodynamic features which lead to a really high energy efficiency. The units therefore need a less filling.

### WARNING

- Appliance filled with flammable gas R32.
- Appliance shall be installed, operated and stored in a room with a floor area larger than  $X \text{ m}^2$ .  
(Please refer to table "a" in section of " Safety operation of flammable refrigerant " for space X.)
- The appliance shall be stored in a room without continuously operating ignition sources.  
(for example: open flames, an operating gas appliance or an operating electric heater.)
- The appliance shall be stored in a well-ventilated area where the room size corresponds to the room area as specified for operation.
- The appliance shall be stored so as to prevent mechanical damage from occurring.
- Ducts connected to an appliance shall not contain an ignition source.
- Keep any required ventilation openings clear of obstruction.
- Do not pierce or burn.
- Be aware that refrigerants may not contain an odour.
- Do not use means to accelerate the defrosting

process or to clean, other than those recommended by the manufacturer.

- Servicing shall be performed only as recommended by the manufacturer.
- Should repair be necessary, contact your nearest authorized Service Centre. Any repairs carried out by unqualified personnel may be dangerous.
- Compliance with national gas regulations shall be observed.
- Read specialist's manual.



Refrigerant Safety Group  
**A2L**



## Safety operation of flammable refrigerant

### Qualification of workers

Qualification of the working personnel for maintenance, service and repair operations should according to UL 60335-2 -40、CAN/C-SA-C22.2 No. 60335-2-40: 22 Annex HH.. Every working procedure that affects safety means shall only be carried out by competent persons according to Annex HH. Special training additional to usual refrigerating equipment repair procedures is required when equipment with FLAMMABLE REFRIGERANTS is affected.

### Installation notes

- The air conditioner must be installed in a room that is larger than the minimum room area. The minimum room area is shown on the nameplate or following table a.
- It is not allowed to drill hole or burn the connection pipe.
- Leak test is a must after installation.

## Safety operation of flammable refrigerant

**table a - Minimum room area ( m<sup>2</sup> )**

Based on UL 60335-2-40 requirements  
The following installation height and area for customer reference.

Charge amount (kg)	Installation height(m)			
	1.8	2.2	2.5	3
	Minimum room area (m <sup>2</sup> )			
<1.836	/	/	/	/
1.836-2.7	9.8	8.1	7.1	5.9
2.8	10.2	8.4	7.4	6.2
2.9	10.6	8.7	7.6	6.4

### Maintenance notes

- Check whether the maintenance area or the room area meet the requirement of the nameplate.
  - It's only allowed to be operated in the rooms that meet the requirement of the nameplate.
- Check whether the maintenance area is well-ventilated.
  - The continuous ventilation status should be kept during the operation process.
- Check whether there is fire source or potential fire source in the maintenance area.
  - The naked flame is prohibited in the maintenance area; and the "no smoking" warning board should be hanged.
- Check whether the appliance mark is in good condition.
  - Replace the vague or damaged warning mark.

### Welding

- If you should cut or weld the refrigerant system pipes in the process of maintaining, please follow the steps as below:
  - a. Shut down the unit and cut power supply
  - b. Eliminate the refrigerant
  - c. Vacuuming
  - d. Clean it with N<sub>2</sub> gas
  - e. Cutting or welding
  - f. Carry back to the service spot for welding
- The refrigerant should be recycled into the specialized storage tank.
- Make sure that there isn't any naked flame near the outlet of the vacuum pump and it's well-ventilated.

### Filling the refrigerant

- Use the refrigerant filling appliances specialized for R32. Make sure that different kinds of refrigerant won't contaminate with each other.
- The refrigerant tank should be kept upright at the time of filling refrigerant.
- Stick the label on the system after filling is finished (or haven't finished).
- Don't overfilling.
- After filling is finished, please do the leakage detection before test running; another time of leak detection should be done when it's removed.

### Safety instructions for transportation and storage

- Please use the flammable gas detector to check before unload and open the container.
- No fire source and smoking.
- According to the local rules and laws.

### Safety of Construction

- For appliances using FLAMMABLE REFRIGERANTS, all joints made in the installation between parts of the REFRIGERATING SYSTEM, with at least one part charged, shall be made in accordance with the following:
  - A brazed, welded, or mechanical connection shall be made before opening the valves to permit refrigerant to flow between the REFRIGERATING SYSTEM parts. A vacuum valve shall be provided to evacuate the interconnecting pipe or any uncharged REFRIGERATING SYSTEM part.
  - Mechanical connectors used indoors shall comply with ISO 14903. When mechanical connectors are reused indoors, sealing parts shall be renewed. When flared joints are reused indoors, the flare part shall be refabricated.
  - Refrigerant tubing shall be protected or enclosed to avoid damage.
  - Flexible refrigerant connectors (such as connecting lines between the indoor and outdoor unit) that may be displaced during NORMAL OPERATION shall be protected against mechanical damage.

## ■ Safety operation of flammable refrigerant

### Pressure test and leak detect

- After completion of field piping for split systems, the field pipework shall be pressure tested with an inert gas and then vacuum tested prior to refrigerant charging, according to the following requirements.

The minimum test pressure for the low side of the system shall be the low side design pressure and the minimum test pressure for the high side of the system shall be the high side design pressure, unless the high side of the system, cannot be isolated from the low side of the system in which case the entire system shall be pressure tested to the low side design pressure.

- Field-made refrigerant joints indoors shall be tightness tested. The test method shall have a sensitivity of 5 grams per year of refrigerant or better under a pressure of at least 0,25 times the maximum allowable pressure. No leak shall be detected.

magnetic interference, chemical substances (such as chemical plants, etc.), flammable gas, combustible and explosive gas and smog, etc.

- Avoid using items containing ethanol (such as perfume, etc.) and smog-producing items (such as cigarettes, etc.) near the refrigerant sensor, otherwise it will lead to abnormal conditions such as false alarms of the refrigerant sensor. If such phenomenon occurs, please contact the after-sales service team for maintenance.
- Only applicable to refrigerant sensor models.

## ■ Notices for using refrigerant sensor

- The refrigerant sensor can monitor whether R32 refrigerant leaks in real time. When the leakage of R32 refrigerant is detected, the sensor will trigger the alarm and emit a buzzer, and the indoor unit will display "EA" code. Meanwhile, the outdoor unit will stop running.
- In case of refrigerant leakage, please open the window immediately for ventilation to reduce the concentration of refrigerant in the room. Meanwhile, check the room to ensure that there is no fire source. After completing the above operations, please leave the room and go to the safe place, and then contact the after-sales service team for maintenance.
- When the refrigerant sensor reaches its service life or is damaged, the indoor unit will display "FE" code. Please contact the after-sales service team to replace the refrigerant sensor.
- Avoid oil and water splashing into the refrigerant sensor, otherwise it may cause damage to the refrigerant sensor.
- Avoid using it in the environment with electro-

## **FCC WARNING**

**WARNING:** Changes or modifications to this unit not expressly approved by the party responsible for compliance could void the user's authority to operate the equipment.

## **FCC STATEMENT**

This device complies with Part 15 of the FCC Rules. Operation is subject to the following two conditions :

(1) this device may not cause harmful interference, and (2) this device must accept any interference received, including interference that may cause undesired operation.

**NOTE:** This equipment has been tested and found to comply with the limits for a Class B digital device, pursuant to part 15 of the FCC Rules. These limits are designed to provide reasonable protection against harmful interference in a residential installation. This equipment generates, uses and can radiate radio frequency energy and, if not installed and used in accordance with the instructions, may cause harmful interference to radio communications.

However, there is no guarantee that interference will not occur in a particular installation. If this equipment does cause harmful interference to radio or television reception, which can be determined by turning the equipment off and on, the user is encouraged to try to correct the interference by one or more of the following measures:

- Reorient or relocate the receiving antenna.
- Increase the separation between the equipment and receiver.
- Connect the equipment into an outlet on a circuit different from that to which the receiver is connected.
- Consult the dealer or an experienced radio/TV technician for help.

## **IC STATEMENT**

This device complies with Industry Canada licence exempt RSS standard(s). Operation is subject to the following two conditions: (1) this device may not cause interference, and (2) this device must accept any interference, including interference that may cause undesired operation of the device.

Le présent appareil est conforme aux CNR d'Industrie Canada applicables aux appareils radio exempts de licence. L'exploitation est autorisée aux deux conditions suivantes : (1) l'appareil ne doit pas produire de brouillage, et (2) l'utilisateur de l'appareil doit accepter tout brouillage radioélectrique subi, même si le brouillage est susceptible d'en compromettre le fonctionnement.

## IC STATEMENT

This equipment complies with FCC's and IC's RF radiation exposure limits set forth for an uncontrolled environment. The antenna(s) used for this transmitter must be installed and operated to provide a separation distance of at least 20 cm from all persons and must not be collocated or operating in conjunction with any other antenna or transmitter. Installers must ensure that 20cm separation distance will be maintained between the device (excluding its handset) and users.

Cet appareil est conforme aux limites d'exposition au rayonnement RF stipulées par la FCC et l'IC pour une utilisation dans un environnement non contrôlé. Les antennes utilisées pour cet émetteur doivent être installées et doivent fonctionner à au moins 20 cm de distance des utilisateurs et ne doivent pas être placées près d'autres antennes ou émetteurs ou fonctionner avec ceux-ci. Les installateurs doivent s'assurer qu'une distance de 20 cm sépare l'appareil (à l'exception du combiné) des utilisateurs.

# Safety precautions



## WARNING

### Installation

- Installation or maintenance must be performed by qualified professionals.
- The appliance shall be installed in accordance with national wiring regulations.
- According to the local safety regulations, use qualified power supply circuit and circuit breaker.
- All wires of indoor unit and outdoor unit should be connected by a professional.
- Be sure to cut off the power supply before proceeding any work related to electricity and safety.
- Make sure the power supply matches with the requirement of air conditioner.
- Unstable power supply or incorrect wiring may result in electric shock, fire hazard or malfunction. Please install proper power supply cables before using the air conditioner.
- The grounding resistance should comply with national electric safety regulations.
- Air Conditioner should be properly grounded. Incorrect grounding may cause electric shock.
- Do not put through the power before finishing installation.
- Do install the circuit breaker. If not, it may cause malfunction.
- Means for disconnection must be incorporated in the fixed wiring in accordance with the wiring rules.
- Circuit breaker should be included magnet buckle and heating buckle function. It can protect the overload and circuit-short.
- Installation must be performed in accordance with the requirement of NEC and CEC by authorized personnel only.

# Safety precautions



## CAUTION

### Installation

- Instructions for installation and use of this product are provided by the manufacturer.
- Select a location which is out of reach for children and far away from animals or plants. If it is unavoidable, please add the fence for safety purpose.
- The indoor unit should be installed close to the wall.
- Don't use unqualified power cord.
- If the length of power connection wire is insufficient, please contact the supplier for a new one.
- The appliance must be positioned so that the plug is accessible.
- For the air conditioner with plug, the plug should be reachable after finishing installation.
- For the air conditioner without plug, a circuit breaker must be installed in the line.
- The yellow-green wire in air conditioner is grounding wire, which can't be used for other purposes.
- The air conditioner is the first class electric appliance. It must be properly grounded with specialized grounding device by a professional. Please make sure it is always grounded effectively, otherwise it may cause electric shock.
- The temperature of refrigerant circuit will be high, please keep the interconnection cable away from the copper tube.

# Safety precautions



## WARNING

- Before operation, please confirm whether power specification complies with that on nameplate.
- Before cleaning or maintaining the air conditioner, please turn off air conditioner and pull out the power plug.
- Make sure the power cord hasn't been pressed by hard objects.
- Do not pull or drag the power cord to pull out the power plug or move the air conditioner.
- Do not insert or pull out the power plug with wet hands. Please use the grounded power. Make sure the grounding is reliable.
- If the SUPPLYCORD is damaged, it must be replaced by the manufacturer, its service agent or similarly qualified persons in order to avoid a hazard.
- If abnormal condition occurs (e. g. burned smell), please disconnect power at once and then contact local dealer.
- When nobody is taking care of the unit, please turn it off and remove the power plug or disconnect power.
- Do not splash or pour water on air conditioner. Otherwise, it may cause short circuit or damage to air conditioner.
- Prohibit operating heating equipment around the air conditioner.
- Prohibit operating the unit in the bathroom or laundry room.
- Far away from fire source, inflammable and explosive objects.
- Children and disabled people are not allowed to use the portable room.

# Safety precautions



## WARNING

- air conditioner without supervision.
- Keep children from playing or climbing on the air conditioner.
- Do not put or hang dripping objects above the air conditioner.
- Do not repair or disassemble the air conditioner by yourself.
- Do not block air outlet or air inlet.
- Prohibit inserting any objects into the air conditioner.
- Do not through sundries into the air duct. If there are sundries get into the air duct, please contact the professionals to deal with it.
- Do not use an extension cord.
- A fuse or circuit breaker should be added at the product circuit. Please refer to the MOP value

on the nameplate for the detailed specification.

- The appliance shall be installed in accordance with national wiring regulations.
- If a STATIONARY APPLIANCE is not fitted with a SUPPLY CORD and a plug, an all-pole disconnection switch having a contact separation of at least 3mm in all poles should be connected in fixed wiring.

# Safety precautions



## WARNING

### Operation and Maintenance

- This appliance can be used by children aged from 8 years and above and persons with reduced physical, sensory or mental capabilities or lack of experience and knowledge if they have been given supervision or instruction concerning use of the appliance in a safe way and understand the hazards involved.
- Children shall not play with the appliance.
- Cleaning and user maintenance shall not be made by children without supervision.
- If the supply cord is damaged, it must be replaced by the manufacturer, its service agent or similarly qualified persons in order to avoid a hazard.
- Do not connect air conditioner to multi-purpose socket. Otherwise, it may cause fire hazard.
- Do not disconnect power supply when cleaning air conditioner. Otherwise, it may cause electric shock.
- Do not wash the air conditioner with water to avoid electric shock.
- Do not spray water on indoor unit. It may cause electric shock or malfunction.
- Do not repair air conditioner by yourself. It may cause electric shock or damage. Please contact dealer when you need to repair air conditioner.
- After removing the filter, do not touch fins to avoid injury.
- Do not extend fingers or objects into air inlet or air outlet. It may cause personal injury or damage.

# Safety precautions



## CAUTION

### Operation and Maintenance



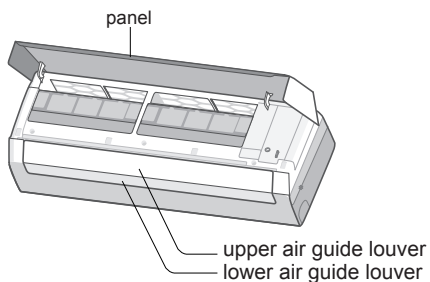
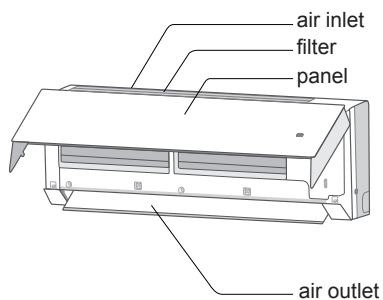

- Do not spill water on the remote controller, otherwise the remote controller may be broken.
- Do not use fire or hair dryer to dry the filter to avoid deformation or fire hazard.
- Do not block air outlet or air inlet. It may cause malfunction.
- Do not step on top panel of outdoor unit, or put heavy objects. It may cause damage or personal injury.
- For appliances made up of more than one factory made assembly specified by the manufacturer to be used together, instructions shall be provided for completing the assembly to ensure compliance with the requirements.
- When below phenomenon occurs, please turn off air conditioner and disconnect power immediately, and then contact the dealer or qualified professionals for service.
  - Power cord is overheating or damaged.
  - There's abnormal sound during operation.
  - Circuit breaker trips off frequently.
  - Air conditioner gives off burning smell.
  - Indoor unit is leaking.

# Parts name

## Indoor Unit



## Display

Heat mode	
Cool mode	
Dry mode	
Temp. indicator	26
Power indicator	
Humidity indicator	%

### NOTE

- This is the general introduction and the color of indicator is only for reference. Please refer to the actual display.
- Display content may be different from the actual. Please refer to the actual display.

# Operation and introduction of remote controller

## Buttons on remote controller



## Introduction for icons on display screen

	Quiet	
	Set fan speed	
	Turbo mode	
	Send signal	
Operation mode		Auto mode
		Cool mode
		Dry mode
		Fan mode
		Heat mode
		X-FAN function
		Humidity control
		Power limiting operation
		Set temperature
	Indoor ambient temp.	
	Indoor ambient humidity	
ON OFF	TIMER ON / TIMER OFF	
	Set time	
	Left & right swing	
	Up & down swing	
	Child lock	
	Fast cool	
WIFI	WiFi function	
	LED	
	Auto LED	
	I Feel function	
	Sleep mode	
	Two-way ventilation function	

## Introduction for buttons on remote controller

### NOTE

- This is a general use remote controller. It could be used for the air conditioner with multifunction. For the functions which the model doesn't have, if press the corresponding button on the remote controller, the unit will keep the original running status.
- After putting through the power, the air conditioner will give out a sound. Power indicator "⏻" is ON. After that, you can operate the air conditioner by using remote controller.
- Under on status, pressing the button on the remote controller, the signal icon "📶" on the display of remote controller will blink once and the air conditioner will give out a "di" sound, which means the signal has been sent to the air conditioner.
- As for the models with functions of WiFi or wired controller, the indoor unit must have been controlled by standard remote controller under auto mode first, and then the function of adjustable temperature under auto mode can be realized by APP or the wired controller.
- This remote controller can adjust the temperature under auto mode. When matching with the unit which is without the function of adjustable temperature under auto mode, the set temperature under auto mode may be invalid, or the displayed set temperature on the unit is not same as that on the remote controller under auto mode.

### ⏻ On/Off button

Press this button to turn on the unit. Press this button again to turn off the unit.

### Mode button

Press this button to select your required operation mode.



- When selecting auto mode, air conditioner will operate automatically according to the sensed temperature. Press "Fan" button can adjust fan speed. Press "🌀" / "🌀" button can adjust fan blowing angle.
- After selecting cool mode, air conditioner will operate under cool mode. Press "+" or "-" button to adjust set temperature. Press "Fan" button to adjust fan speed. Press "🌀" / "🌀" button to adjust fan blowing angle.
- When selecting dry mode, the air conditioner operates at low speed under dry mode. Under dry mode, fan speed can't be adjusted. Press "🌀" / "🌀" button to adjust fan blowing angle.
- When selecting fan mode, the air conditioner will

only blow fan, no cooling and no heating. Press "Fan" button to adjust fan speed. Press "🌀" / "🌀" button to adjust fan blowing angle.

- When selecting heat mode, the air conditioner operates under heat mode. Press "+" or "-" button to adjust set temperature. Press "Fan" button to adjust fan speed. Press "🌀" / "🌀" button to adjust fan blowing angle.

### NOTE

- For preventing cold air, after starting up heating mode, indoor unit will delay 1~5 minutes to blow air (actual delay time is depend on indoor ambient temperature).
- Set temperature can be adjusted under AUTO mode.
- Set temperature range from remote controller: 16~30°C (61-86°F). Set temperature range from remote controller under HEAT mode: 8~30°C (46-86°F).
- This mode indicator is not available for some models.

### Fan button

This button is used for setting Fan Speed in the sequence that goes from AUTO, 🌀, ■, ■■, ■■■, ■■■■, ■■■■■ to 🌀, then back to Auto.

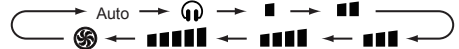

- Low speed ■■ Low-Medium speed
- Medium speed ■■■■ Medium-High speed
- High speed 🌀 Turbo speed 🌀 Quiet speed

### NOTE

- Under AUTO speed, air conditioner will select proper fan speed automatically according to factory default setting.
- It's low fan speed under dry mode.
- X-FAN function: Holding fan speed button for 2s in cool or dry mode, the icon "🌀" is displayed and the indoor fan will continue operation for a few minutes in order to dry the indoor unit even though you have turned off the unit. After energization, X-FAN OFF is defaulted. X-FAN is not available in auto, fan or heat mode.  
This function indicates that moisture on evaporator of indoor unit will be blown after the unit is stopped to avoid mould.
- Having set X-FAN function on: After turning off the unit by pressing On/Off button, indoor fan will continue running for a few minutes at low speed. In this period, hold fan speed button for 2s to stop indoor fan directly.
- Having set X-FAN function off: After turning off the unit by pressing On/Off button, the complete unit will be off directly.

## + / - button

Press "+" or "-" button once increase or decrease set temperature 1°C(°F). Holding "+" or "-" button, 2s later, set temperature on remote controller will change quickly. On releasing button after setting is finished, temperature indicator on indoor unit will change accordingly.

## Wifi button

Press "Wifi" button to turn on WiFi function, "Wifi" icon will be displayed on the remote controller; Hold "Wifi" button for 5s to turn off WiFi function and "Wifi" icon will disappear. (This function is only available for some models.)

Under off status, press "Mode" and "Wifi" buttons simultaneously for 1s, WiFi module will restore factory settings.

### NOTE

- This function is only available for some models.

## I Feel button

Press this button to start I Feel function and "I Feel" icon will be displayed on the remote controller. After this function is set, the remote controller will send the detected ambient temperature to the controller and the unit will automatically adjust the indoor temperature according to the detected temperature. Press this button again to close I Feel function and "I Feel" icon will disappear.

Please put the remote controller near user when this function is set. Do not put the remote controller near the object of high temperature or low temperature in order to avoid detecting inaccurate ambient temperature. When I Feel function is turned on, the remote controller should be put within the area where indoor unit can receive the signal sent by the remote controller.

## UD-swing button

Press this button can select up & down swing angle. Fan blow angle can be selected circularly as below:

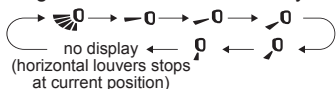

- When selecting "fan icon with right arrow", air conditioner is blowing fan automatically. Horizontal louver will automatically swing up & down at maximum angle.
- When selecting "horizontal line with left arrow", air conditioner is blowing fan at fixed position. Horizontal louver will stop at the fixed position.
- Hold "fan icon with right arrow" button above 2s to set your required

swing angle. When reaching your required angle, release the button.

### NOTE

- Press this button continuously more than 2s, the main unit will swing back and forth from up to down, and then loosen the button, the unit will stop swinging and present position of guide louver will be kept immediately.
- Under swing up and down mode, when the status is switched from off to "fan icon with right arrow", if press this button again 2s later, "fan icon with right arrow" status will switch to off status directly; if press this button again within 2s, the change of swing status will also depend on the circulation sequence stated above.

## Humidity button

Under cooling mode, press this button can select humidity control with cooling mode, smart dehumidification with cooling mode, and general cooling mode, and they can be set to operate circularly.

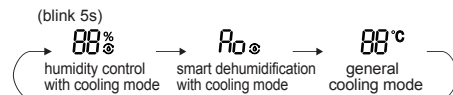

- When humidity control with cooling mode is set, the remote controller will display "88%" and humidity icon will blink for 5s; you can press "+" and "-" buttons to set the humidity value within 5s.

Under humidity control with cooling mode, humidity setting range for the remote controller: 40%-80%.

Temperature can be adjusted under humidity control with cooling mode.

- When smart dehumidification with cooling mode is set, the remote controller will display "Ao" ; the remote controller and indoor unit will display "Ao" for 5 seconds.

Temperature can be adjusted under smart dehumidification with cooling mode.

- The humidity for smart dehumidification is automatically adjusted according to human body comfort; no need to set the humidity manually.

Under dry mode, press this button can select humidity control with dehumidification mode, continuous dehumidification mode, general dehumidification mode, and they can be set to operate circularly.



- When humidity control with dehumidification mode is set, the remote controller will display "88%", "%"

and humidity value "88"; you can press "+" and "-" buttons to set the humidity value. Humidity setting range for the remote controller: 30%-70%.

Temperature can't be adjusted under humidity control with dehumidification mode.

- When continuous dehumidification is set, the remote controller will display "☺"; the remote controller and indoor unit will display "Co".

Temperature can't be adjusted under continuous dehumidification mode.

- Under continuous dehumidification mode, the unit always works under dehumidification status; no need to set temperature and humidity.

**NOTE**



- The air conditioner is mainly used for controlling the temperature, while the humidity control is the auxiliary function. The humidity will be affected by the factors such as indoor and outdoor environment, degree of indoor sealing and indoor flow.
- When the set humidity is higher than current atmospheric humidity, the set humidity can't be reached.
- If the humidity sensor is with malfunction, humidity setting under cooling mode or dehumidification mode will stop and the unit operates under general cooling mode or dehumidification mode.

 LR-swing button

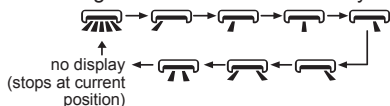
Press this button can select left & right swing angle. Fan blow angle can be selected circularly as below:



**NOTE**

- Press this button continuously more than 2s, the main unit will swing back and forth from left to right, and then loosen the button, the unit will stop swinging and present position of guide louver will be kept immediately.
- Under swing left and right mode, when the status is switched from off to , if press this button again 2s later,  status will switch to off status directly; if press this button again within 2s, the change of swing status will also depend on the circulation sequence stated above.
- This function only applicable for some models.

 Timer button

- At ON status, press this button once can set TIMER OFF. The character of HOUR and OFF will flash. Press "+" or "-" button within 5s can

adjust the time of TIMER OFF. After each pressing of "+" or "-" button, time will increase or decrease half an hour. When holding "+" or "-" button, 2s later, the time will change quickly until to reach to your required time. After that, press "Timer" button to confirm it. The character of HOUR and OFF won't flash again.

Cancel TIMER OFF: Press "Timer" button again under TIMER OFF status.

- At OFF status, press this button once can set TIMER ON. Please refer to TIMER off for detailed operation.

Cancel TIMER ON: Press "Timer" button again under TIMER ON status.

**NOTE**

- Time setting range: 0.5-24 hours.
- Time interval between two operations can't exceed 5s. Otherwise, remote controller will exit the setting status automatically.

 Sleep button

Press this button, can select Sleep 1 (☺1), Sleep 2 (☺2), Sleep 3 (☺3) and cancel the Sleep, circulate between these, after electrified, Sleep Cancel is defaulted.

- Sleep 1 is Sleep mode 1, in Cool modes: sleep status after run for one hour, the main unit setting temperature will increase 1, two hours, setting temperature increased 2, then the unit will run at this setting temperature; In Heat mode: sleep status after run for one hour, the setting temperature will decrease 1, two hours, setting temperature will decrease 2, then the unit will run at this setting temperature.
- Sleep 2 is sleep mode 2, that is air conditioner will run according to the presetting a group of sleep temperature curve.
- Sleep 3 the sleep curve setting under Sleep mode by DIY;
  - (1) Under Sleep 3 mode, press "I Feel" button for a long time, remote controller enters into user individual sleep setting status, at this time, the time of remote controller will display "1HOUR", the setting temperature "88" will display the corresponding temperature of last setting sleep curve and blink (The first entering will display according to the initial curve setting value of original factory);
  - (2) Adjust "+" and "-" button, could change the corresponding setting temperature, after adjusted, press "I Feel" button for confirmation;
  - (3) At this time, 1hour will be automatically increased at the timer position on the remote control, (that is "2HOUR" or "3HOUR" or "8HOUR"), the place of setting temperature "88" will display the corres-

ponding temperature of last setting sleep curve and blink;

(4) Repeat the above step (2)~(3) operation, until 8 hours temperature setting finished, sleep, curve setting finished, at this time, the remote controller will resume the original timer display; temperature display will resume to original setting temperature.

- Sleep 3 the sleep curve setting under Sleep mode by DIY could be inquired:

The user could accord to sleep curve setting method to inquire the presetting sleep curve, enter into user individualisation sleep setting status, but do not change the temperature, press "I Feel" button directly for confirmation. Note: In the above presetting or enquiry procedure, if continuously within 10s, there is no button pressed, the sleep curve setting within 10s, there is no button pressed, the sleep curve setting status will be automatically quit and resume to display the original displaying. In the presetting or enquiry procedure, press "On/Off" button, "Mode" button, "Timer" button or "Sleep" button, the sleep curve setting or enquiry status will quit similarly.

### Light button

Press this button to control the LED status on the display, the circulation change is as follow:

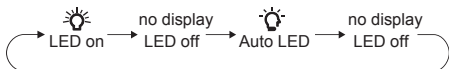

When selecting "  " (Auto LED) with remote controller, LED indicator on indoor unit will adjust the luminance automatically according to the ambient intensity of illumination.

## Function introduction for combination buttons



### Energy-saving function

Under cooling mode, press "Mode" and "Timer" buttons simultaneously to start up or turn off energy-saving function. When energy-saving function is started up, "SE" will be shown on remote controller, and air conditioner will adjust the set temperature automatically according to ex-factory setting to reach to the best energy-saving effect. Press "Mode" and "Timer" buttons simultaneously again to exit energy-saving function.

### NOTE

- Under energy-saving function, fan speed is defaulted at auto speed and it can't be adjusted.
- Under energy-saving function, set temperature can't be adjusted.
- Sleep function and energy-saving function can't operate at the same time. If energy-saving function has been set under cool mode, press "Sleep" button will cancel energy-saving function. If sleep function has been set under cool mode, start up the energy-saving function will cancel sleep function.

### Child lock function

Hold "On/Off" and "-" buttons simultaneously for 3s to turn on or turn off child lock function. When child lock function is on, "  " icon is displayed on remote controller. If you operate the remote controller, the "  " icon will blink three times without sending signal to the unit.



### Temperature display switchover function

Under OFF status, hold "Mode" and "-" buttons simultaneously for 3s to switch temperature display between °C and °F.

### function

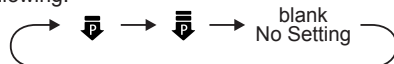
 function is for limiting power of the whole unit. Press "Mode" and "Sleep" buttons simultaneously, the remote controller will circularly display as the following:



- Maximum power limited under the  mode is lower than that of  mode.
- If you want to cancel the power limiting function, press "Mode" and "Sleep" buttons simultaneously till the icon in remote controller is not displayed.
- When the remote controller is turned off, power limiting function is cancelled. If you want to activate the function, please repress "Mode" and "Sleep" buttons simultaneously.
- If the current power is lower than the maximum power of  mode, then the power will not be limited after entering into such mode.
- For the model with one outdoor unit and two indoor units, if any one of indoor units enters into power limiting function, the outdoor unit will enter into the set limiting power mode of indoor unit; when two

indoor units enter into power limiting mode, then the power of outdoor unit will be limited according to the lower power of the two indoor units.

#### NOTE

- This button is only available for the model with such function.

#### Indoor ambient temperature or humidity display

By holding "On/Off" and "🏠" buttons simultaneously, you can see indoor ambient temperature or indoor ambient humidity on indoor unit's display. The setting on remote controller is selected circularly as below:



- When selecting "🏠" with remote controller, temperature indicator on indoor unit displays indoor ambient temperature.
- When selecting "🏠" with remote controller, temperature indicator on indoor unit displays indoor ambient humidity.

#### NOTE

- The ambient humidity value is only for reference. Eg: If humidity value is "0%", there may be malfunction for the humidity detection board. Please contact local service provider.
- There may be some measuring deviation for humidity detection and photosensitivity detection.

#### Clean reminder function of filter

The reminder function is defaulted to be OFF. Hold "On/Off" and "🏠" buttons simultaneously for 5s to turn it on. The buzzer will give out sound for 0.5s and the dual-8 nixie tube on the display will be on for 3s; Once the reminder function is turned on, when the air conditioner has reached to the set time, the dual-8 nixie tube will flash about 30s when the unit is turned on each time to remind the user to clean the filter; you can turn off this cycle reminder by holding "On/Off" and "🏠" buttons simultaneously for 5s and then the air conditioner will count time again.

#### NOTE

- Once the reminder function is turned on, only this cycle reminder can be cleared.
- This function is only available for some models.

#### Volume control of IDU Buzzer

Press "Mode" and "🔊" buttons simultaneously to reduce the sound level of the indoor unit's buzzer.

#### NOTE

- This function is only available for some models.

#### Fast cool function

Press "On/Off" and "+" buttons simultaneously under cooling mode can select 25°C(77°F) fast cooling mode, 16°C(61°F) fast cooling mode and normal cooling mode circularly. "❄️" icon will be displayed on the remote controller under fast cooling mode.

Once it enters into fast cooling mode, the fan speed is auto fan and the set temperature is 25°C(77°F) or 16°C(61°F). At this time, the set temperature flashes to display for 5s. In the flashing period, press "+" or "-" button to adjust the set temperature.

Press "Fan" button to adjust the fan speed. If the set temperature and the fan speed haven't been adjusted during that time, the remote controller and the indoor unit will operate under current set temperature and fan speed for 20 minutes. 20 minutes later, the set temperature and the fan speed for the remote controller and the indoor unit will turn to the status before quick cooling.

#### NOTE

- If the set temperature and the fan speed have been adjusted during the operation under fast cooling mode, the unit will exit from the fast cooling mode. Then the indoor unit operates continuously under the adjusted status.
- Fast cooling function is only applicable for some models. If this function is unavailable for this indoor unit, 20 minutes later, the remote controller will turn back to the status before fast cooling. Indoor unit operates continuously according to current status. At this time, status of indoor unit and the display status on the remote controller may be different.
- This function is only available for some models.

#### Auto clean function

Under unit off status, hold "Mode" and "🏠" buttons simultaneously for 5s to turn on or turn off the auto clean function. When the auto clean function is turned on, indoor unit displays "CL". During the auto clean process of evaporator, the unit will perform fast cooling or fast heating. There may be

some noise, which is the sound of flowing liquid or thermal expansion or cold shrinkage. The air conditioner may blow cool or warm air, which is a normal phenomenon. During cleaning process, please make sure the room is well ventilated to avoid affecting the comfort.

#### NOTE

- The auto clean function can only work under normal ambient temperature. If the room is dusty, clean it once a month; if not, clean it once every three months. After the auto clean function is turned on, you can leave the room. When auto clean is finished, the air conditioner will enter standby status.
- This function is only available for some models.

### Night mode

Under cooling or heating mode, when turning on sleep mode and turn to low speed or quiet notch, the outdoor unit would enter into night mode.

#### NOTE

- When you feel that the cooling and heating effect is poor, please press "Fan" button to other fan speed or press "Sleep" button to exit the night mode.
- The night mode can only work under normal ambient temperature.
- This function is only available for some models.

### Two-way ventilation function

Under turning on, press "Mode" and "I Feel" buttons simultaneously to start up or turn off two-way ventilation function. When two-way ventilation function is started up,  will be shown on remote controller, and the light of the two-way ventilation system is turned on. Fan speed will be adjusted according to the fan speed of air conditioner.

Under turning off, press "Mode" and "I Feel" buttons simultaneously to start up or turn off two-way ventilation function only. When two-way ventilation function is started up,  will be shown on remote controller, and the light of the two-way ventilation system is turned on. Fan speed will be adjusted according to fan button on remote controller.

#### NOTE

- This function is only available for some models.

### Replacement of batteries in remote controller

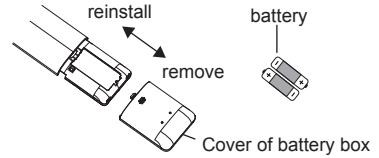

1. Press the back side of remote controller marked with "", as shown in the fig, and then push out the cover of battery box along the arrow direction.
2. Replace two 7# (AAA 1.5V) dry batteries, and make sure the position of "+" polar and "-" polar are correct.
3. Reinstall the cover of battery box.

#### NOTICE

- During operation, point the remote control signal sender at the receiving window on indoor unit.
- The distance between signal sender and receiving window should be no more than 8m, and there should be no obstacles between them.
- Signal may be interfered easily in the room where there is fluorescent lamp or wireless telephone; remote controller should be close to indoor unit during operation.
- Replace new batteries of the same model when replacement is required.
- When you don't use remote controller for a long time, please take out the batteries.
- If the display on remote controller is fuzzy or there's no display, please replace batteries.

## Clean and maintenance

### ⚠ WARNING

- Turn off the air conditioner and disconnect the power before cleaning the air conditioner to avoid electric shock.
- Do not wash the air conditioner with water to avoid electric shock.
- Do not use volatile liquid to clean the air conditioner.
- Do not use liquid or corrosive detergent to clean the appliance and do not splash water or other liquid onto it, otherwise, it may damage the plastic components, even cause electric shock.

### Clean surface of indoor unit

When the surface of indoor unit is dirty, it is recommended to use a soft dry cloth or wet cloth to wipe it.

#### NOTICE

- Do not remove the panel when cleaning it.

### Clean filter

#### 1. Remove filter

Press the spring fasteners at both sides in the direction indicated by the arrows. Meanwhile, lift up the filter so that it is separated from the fasteners. Pull the filter forward and remove it.

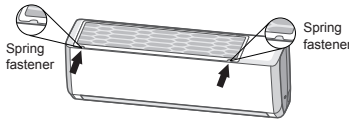

#### 2. Clean filter

Use clear water to wash it or dust catcher to clean it. If the filter is very dirty (such as grease), use warm water (45 °C) dissolved with neutral detergent to clean it, and then put it at the shady place to dry it.

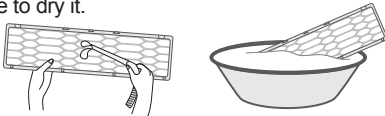

#### 3. Install filter

After cleaning, reinstall the filter in reverse order. Push it along the guide rails at both sides and then press the left and right edges of the filter. Refit the filter in the direction indicated by the arrows.

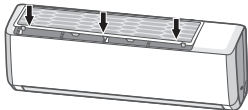

### ⚠ WARNING

- The filter should be cleaned every three months. If there is much dust in the operation environment, clean frequency can be increased.
- After removing the filter, do not touch fins to avoid injury.
- Do not use fire or hair dryer to dry the filter to avoid deformation or fire hazard.

#### NOTICE: Checking before use-season

1. Check whether air inlets and air outlets are blocked.
2. Check whether air switch, plug and socket are in good condition.
3. Check whether filter is clean.
4. Check whether mounting bracket for outdoor unit is damaged or corroded. If yes, please contact dealer.
5. Check whether drainage pipe is damaged.

#### NOTICE: Checking after use-season

1. Disconnect power supply.
2. Clean filter and indoor unit's panel.
3. Check whether mounting bracket for outdoor unit is damaged or corroded. If yes, please contact dealer.

### Notice for recovery

1. Many packing materials are recyclable materials. Please dispose them in appropriate recycling unit.
2. If you want to dispose the air conditioner, please contact local dealer or consultant service center for the correct disposal method.

### ■ Error Code

When air conditioner status is abnormal, temperature indicator on indoor unit will blink to display corresponding error code. Please refer to below list for identification of error code.

Error code	Troubleshooting
U8, H6, H3, E1, E5, E6, E8	It can be eliminated after restarting the unit. If not, please contact qualified professionals for service.
C5, F0, F1, F2	Please contact qualified professionals for service.

#### NOTE

- If there're other error codes, please contact qualified professionals for service.

# Checked items before maintenance

## General phenomenon analysis

Please check below items before asking for maintenance. If the malfunction still can't be eliminated, please contact local dealer or qualified professionals.

Phenomenon	Check items	Solution
Indoor unit can't receive remote controller's signal or remote controller has no action.	Whether it's interfered severely (such as static electricity, stable voltage?)	Pull out the plug. Reinsert the plug after about 3min, and then turn on the unit again.
	Whether remote controller is within the signal receiving range?	Signal receiving range is 8m.
	Whether there are obstacles?	Remove obstacles.
	Whether remote controller is pointing at the receiving window?	Select proper angle and point the remote controller at the receiving window on indoor unit.
	Is sensitivity of remote controller low; fuzzy display or no display?	Check the batteries. If the power of batteries is too low, please replace them.
	No display when operating remote controller?	Check whether remote controller appears to be damaged. If yes, replace it.
	Fluorescent lamp in room?	Take the remote controller close to indoor unit. Turn off the fluorescent lamp and then try it again.
No air emitted from indoor unit	Air inlet or air outlet of indoor unit is blocked?	Eliminate obstacles.
	Under heating mode, indoor temperature is reached to set temperature?	After reaching to set temperature, indoor unit will stop blowing out air.
	Heating mode is turned on just now?	In order to prevent blowing out cold air, indoor unit will be started after delaying for several minutes, which is a normal phenomenon.
Air conditioner can't operate	Power failure?	Wait until power recovery.
	Is plug loose?	Reinsert the plug.
	Air switch trips off or fuse is burnt out?	Ask professional to replace air switch or fuse.
	Wiring has malfunction?	Ask professional to replace it.
	Unit has restarted immediately after stopping operation?	Wait for 3min, and then turn on the unit again.
	Whether the function setting for remote controller is correct?	Reset the function.
Mist is emitted from indoor unit's air outlet	Indoor temperature and humidity is high?	Because indoor air is cooled rapidly. After a while, indoor temperature and humidity will decrease and mist will disappear.

Phenomenon	Check items	Solution
Odours are emitted	Whether there's odour source, such as furniture and cigarette, etc.	Eliminate the odour source. Clean the filter.
Set temperature can't be adjusted	Your required temperature exceeds the set temperature range?	Set temperature range: 16°C ~30°C. Set temperature range in HEAT mode: 8°C ~30°C.
Cooling (heating) effect is not good.	Voltage is too low?	Wait until the voltage resumes normal.
	Filter is dirty?	Clean the filter.
	Set temperature is in proper range?	Adjust temperature to proper range.
	Door and window are open?	Close door and window.
Air conditioner operates abnormally	Whether there's interference, such as thunder, wireless devices, etc.	Disconnect power, put back power, and then turn on the unit again.
"Water flowing" noise	Air conditioner is turned on or turned off just now?	The noise is the sound of refrigerant flowing inside the unit, which is a normal phenomenon.
Cracking noise	Air conditioner is turned on or turned off just now?	This is the sound of friction caused by expansion and or contraction of panel or other parts due to the change of temperature.
Air guide louver can't be closed normally	Whether the air guide louver has been adjusted?	Disconnect the power for 3s and then connect the power; if the problem still exists, disconnect the power, reinstall the air guide louver (install the upper air guide louver and then install the lower air guide louver) and then connect the power.

### WARNING

- When below phenomenon occurs, please turn off air conditioner and disconnect power immediately, and then contact the dealer or qualified professionals for service.
  - Power cord is overheating or damaged.
  - There's abnormal sound during operation.
  - Air switch trips off frequently.
  - Air conditioner gives off burning smell.
  - Indoor unit is leaking.
- Do not repair or refit the air conditioner by yourself.
- If the air conditioner operates under abnormal conditions, it may cause malfunction, electric shock or fire hazard.

## Installation notice

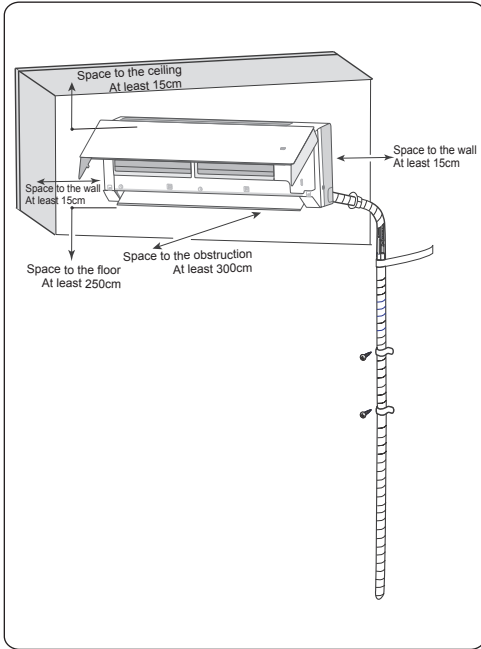

### ■ Safety precautions for installing and relocating the unit

To ensure safety, please be mindful of the following precautions.

#### ⚠ WARNING

- **When installing or relocating the unit, be sure to keep the refrigerant circuit free from air or substances other than the specified refrigerant.**

Any presence of air or other foreign substance in the refrigerant circuit will cause system pressure rise or compressor rupture, resulting in injury.

- **When installing or moving this unit, do not charge the refrigerant which is not comply with that on the nameplate or unqualified refrigerant.**

Otherwise, it may cause abnormal operation, wrong action, mechanical malfunction or even serious safety accident.

- **When refrigerant needs to be recovered during relocating or repairing the unit, be**

#### ⚠ WARNING

sure that the unit is running in cooling mode. Then, fully close the valve at high pressure side (liquid valve). About 30-40 seconds later, fully close the valve at low pressure side (gas valve), immediately stop the unit and disconnect power. Please note that the time for refrigerant recovery should not exceed 1 minute.

If refrigerant recovery takes too much time, air may be sucked in and cause pressure rise or compressor rupture, resulting in injury.

- **During refrigerant recovery, make sure that liquid valve and gas valve are fully closed and power is disconnected before detaching the connection pipe.**

If compressor starts running when stop valve is open and connection pipe is not yet connected, air will be sucked in and cause pressure rise or compressor rupture, resulting in injury.

- **When installing the unit, make sure that connection pipe is securely connected before the compressor starts running.**

If compressor starts running when stop valve is open and connection pipe is not yet connected, air will be sucked in and cause pressure rise or compressor rupture, resulting in injury.

- **Prohibit installing the unit at the place where there may be leaked corrosive gas or flammable gas.**

If there is leaked gas around the unit, it may cause explosion and other accidents.

- **Do not use extension cords for electrical connections. If the electric wire is not long enough, please contact a local service center authorized and ask for a proper electric wire.**

Poor connections may lead to electric shock or fire.

- **Use the specified types of wires for electrical connections between the indoor and outdoor units. Firmly clamp the wires so that their terminals receive no external stresses.**

Electric wires with insufficient capacity, wrong wire connections and insecure wire terminals may cause electric shock or fire.

### ■ Tools for installation

- |                 |                    |                         |
|-----------------|--------------------|-------------------------|
| ① Level meter   | ⑦ Open-end wrench  | ⑫ Universal meter       |
| ② Screw driver  | ⑧ Pipe cutter      | ⑬ Inner hexagon spanner |
| ③ Impact drill  | ⑨ Leakage detector | ⑭ Measuring tape        |
| ④ Drill head    | ⑩ Vacuum pump      |                         |
| ⑤ Pipe expander | ⑪ Pressure meter   |                         |
| ⑥ Torque wrench |                    |                         |

#### NOTICE

- Please contact the local agent for installation.
- Don't use unqualified power cold.

## ■ Selection of installation location

### Basic requirement

Installing the unit in the following places may cause malfunction. If it is unavoidable, please consult the local dealer:

1. The place with strong heat sources, vapors, flammable or explosive gas, or volatile objects spread in the air.
2. The place with high-frequency devices (such as welding machine, medical equipment).
3. The place near coast area.
4. The place with oil or fumes in the air.
5. The place with sulfureted gas.
6. Other places with special circumstances.
7. The appliance shall not be installed in the laundry.
8. It's not allowed to be installed on the unstable or motive base structure (such as truck) or in the corrosive environment (such as chemical factory).

### Indoor unit

1. There should be no obstruction near air inlet and air outlet.
2. Select a location where the condensation water can be dispersed easily and won't affect other people.
3. Select a location which is convenient to connect the outdoor unit and near the power socket.
4. Select a location which is out of reach for children.
5. The location should be able to withstand the weight of indoor unit and won't increase noise and vibration.
6. The appliance must be installed 2.5m above floor.
7. Don't install the indoor unit right above the electric appliance.
8. Please try your best to keep way from fluorescent lamp.

### Safety precaution

1. Must follow the electric safety regulations when installing the unit.
2. According to the local safety regulations, use qualified power supply circuit and air switch.
3. Make sure the power supply matches with the requirement of air conditioner. Unstable power supply or incorrect wiring or malfunction. Please install proper power supply cables before using the air conditioner.
4. Properly connect the live wire, neutral wire and grounding wire of power socket.
5. Be sure to cut off the power supply before proceeding any work related to electricity and safety.
6. Do not put through the power before finishing installation.

## ■ Requirements for electric connection

7. If the supply cord is damaged, it must be replaced by the manufacturer, its service agent or similarly qualified persons in order to avoid a hazard.
8. The temperature of refrigerant circuit will be high, please keep the interconnection cable away from the copper tube.
9. The appliance shall be installed in accordance with national wiring regulations.
10. Installation must be performed in accordance with the requirement of NEC and CEC by authorized personnel only.

### Grounding requirement

1. The air conditioner is the first class electric appliance. It must be properly grounded with specialized grounding device by a professional. Please make sure it is always grounded effectively, otherwise it may cause electric shock.
2. The yellow-green wire in air conditioner is grounding wire, which can't be used for other purposes.
3. The grounding resistance should comply with national electric safety regulations.
4. The appliance must be positioned so that the plug is accessible.
5. An all-pole disconnection switch having a contact separation of at least 3mm in all poles should be connected in fixed wiring.

Air-conditioner	Specification of connection wires for indoor units and outdoor units
24K	4×AWG18

# Installation of indoor unit

## Step 1:

### Choose installation location

Recommend the installation location to the client and then confirm it with the client.

## Step 2:

### Install wall-mounting frame

1. Hang the wall-mounting frame on the wall; adjust it in horizontal position with the level meter and then point out the screw fixing holes on the wall.
2. Drill the screw fixing holes on the wall with impact drill (the specification of drill head should be the same as the plastic expansion particle) and then fill the plastic expansion particles in the holes.
3. Fix the wall-mounting frame on the wall with tapping screws and then check if the frame is firmly installed by pulling the frame. If the plastic expansion particle is loose, please drill another fixing hole nearby.

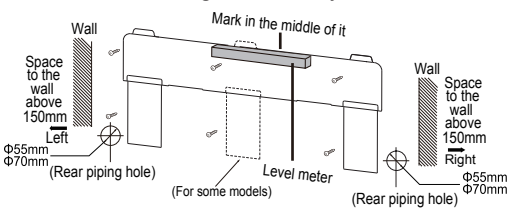

## Step 3:

### Open piping hole

1. Choose the position of piping hole according to the direction of outlet pipe. The position of piping hole should be a little lower than the wall-mounted frame, shown as below.

#### NOTE

- The wall panel is for illustrative purposes only, please refer to the actual installation.
- Please refer to the actual circumstances for the number of screws and the position of screws.

2. When installation is finished, pull the mounting plate with hand to confirm whether it is fixed tightly. The force distribution for all screws should be uniform.
3. Open a piping hole with the diameter of  $\phi 55$  or  $\phi 70$  on the selected outlet pipe position. In order to drain smoothly, slant the piping hole on the wall slightly downward to the outdoor side with the gradient of  $5-10^\circ$ .

#### NOTE

- Pay attention to dust prevention and take relevant safety measures when opening the hole.

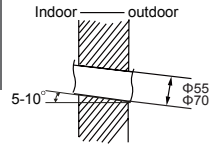

## Step 4:

### Outlet pipe

1. The pipe can be led out in the direction of right, rear right, left or rear left.

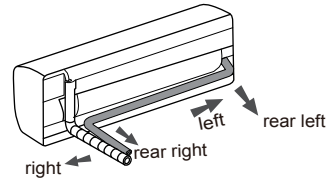

2. When select leading out the pipe from left or right, please cut off the corresponding hole on the bottom case.

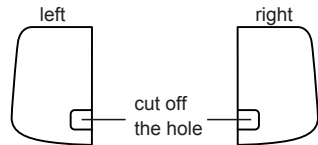

## Step 5:

### Connect the pipe of indoor unit

1. Aim the pipe joint at the corresponding bellmouth.
2. Pretighten the union nut with hand.

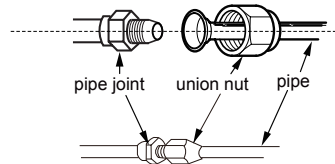

3. Adjust the torque force by referring to the following sheet. Place the open-end wrench on the pipe joint and place the torque wrench on the union nut. Tighten the union nut with torque wrench.

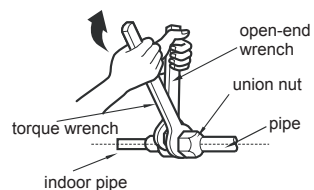

Hex nut diameter	Tightening torque (N.m)
1/4"	15~20
3/8"	30~40
1/2"	45~55
5/8"	60~65
3/4"	70~75

4. Wrap the indoor pipe and joint of connection pipe with insulating pipe, and then wrap it with tape.

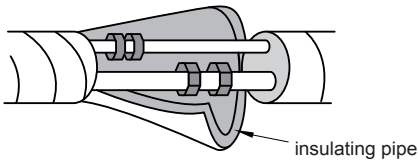

### Step 6: Install drain hose

1. Connect the drain hose to the outlet pipe of indoor unit.

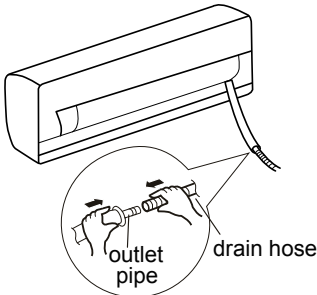

2. Bind the joint with tape.

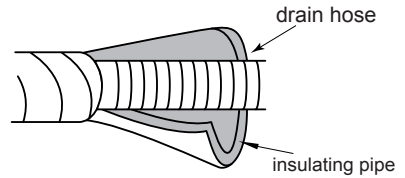
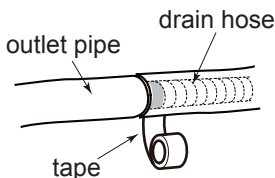

#### NOTE

- Add insulating pipe in the indoor drain hose in order to prevent condensation.
- The plastic expansion particles are not provided.

### Step 7: Connect wire of indoor unit

#### NOTICE

- All wires of indoor unit and outdoor unit should be connected by a professional.
- If the length of power connection wire is insufficient, please contact the supplier for a new one. Avoid extending the wire by yourself.
- For the air conditioner with plug, the plug should be reachable after finishing installation.
- For the air conditioner without plug, an air switch must be installed in the line. The air switch should be all-pole parting and the contact parting distance should be more than 3mm.

1. Open the panel, remove the screw on the wiring cover and then take down the cover.

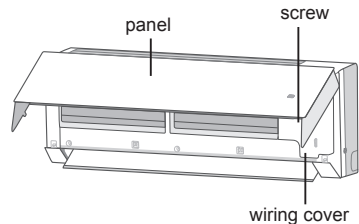

2. Make the power connection wire go through the cable-cross hole at the back of indoor unit and then pull it out from the front side.

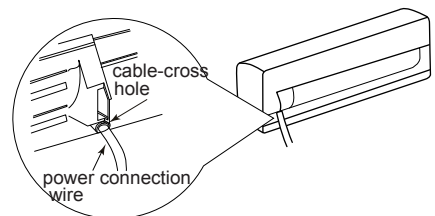

- Remove the wire clip; connect the power connection wire to the wiring terminal according to the color; tighten the screw and then fix the power connection wire with wire clip.

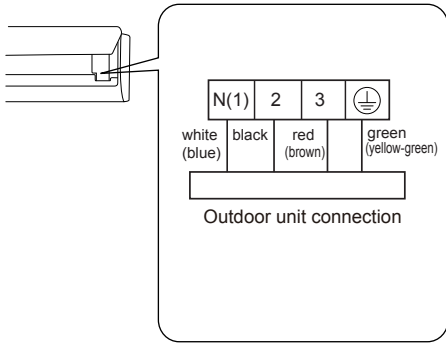

**NOTICE**

- The wiring board is for reference only, please refer to the actual one.

- Put wiring cover back and then tighten the screw.
- Close the panel.

**Step 8:  
Bind up pipe**

- Bind up the connection pipe, power cord and drain hose with the band.

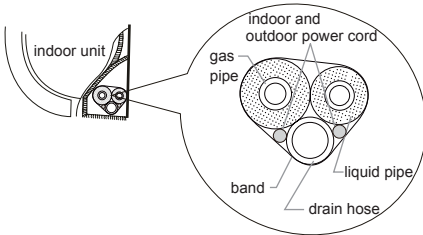

- Reserve a certain length of drain hose and power cord for installation when binding them. When binding to a certain degree, separate the indoor power and then separate the drain hose.

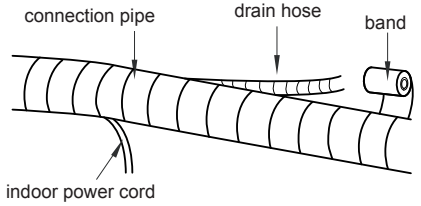

- Bind them evenly.
- The liquid pipe and gas pipe should be bound separately at the end.

**NOTICE**

- The power cord and control wire can't be crossed or winding.
- The drain hose should be bound at the bottom.

**Step 9:  
Hang the indoor unit**

- Put the bound pipes in the wall pipe and then make them pass through the wall hole.
- Hang the indoor unit on the wall-mounting frame.
- Stuff the gap between pipes and wall hole with sealing gum.
- Fix the wall pipe.
- Check if the indoor unit is installed firmly and closed to the wall.

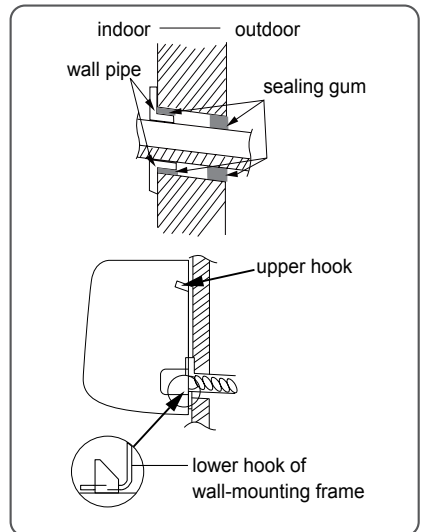

**NOTICE**

- Do not bend the drain hose too excessively in order to prevent blocking.

# Test and operation

## ■ Check after installation

- Check according to the following requirement after finishing installation.

Items to be checked	Possible malfunction
Has the unit been installed firmly?	The unit may drop, shake or emit noise.
Have you done the refrigerant leakage test?	It may cause insufficient cooling(heating) capacity.
Is heat insulation of pipeline sufficient?	It may cause condensation and water dripping.
Is water drained well?	It may cause condensation and water dripping.
Is the voltage of power supply according to the voltage marked on the nameplate?	It may cause malfunction or damage the parts.
Is electric wiring and pipeline installed correctly?	It may cause malfunction or damage the parts.
Is the unit grounded securely?	It may cause electric leakage.
Does the power cord follow the specification?	It may cause malfunction or damage the parts.
Is there any obstruction in the air inlet and outlet?	It may cause insufficient cooling(heating) capacity.
The dust and sundries caused during installation are removed?	It may cause malfunction or damage the parts.
The gas valve and liquid valve of connection pipe are open completely?	It may cause insufficient cooling (heating) capacity.
Is the inlet and outlet of piping hole been covered?	It may cause insufficient cooling (heating) capacity or waste electricity.

## ■ Test operation

### 1. Preparation of test operation

- The client approves the air conditioner.
- Specify the important notes for air conditioner to the client.

### 2. Method of test operation

- Put through the power, press On/Off button on the remote controller to start operation.
- Press MODE button to select AUTO, COOL, DRY, FAN and HEAT to check whether the operation is normal or not.
- If the ambient temperature is lower than 16°C(61°F), the air conditioner can't start cooling.

## Pipe expanding method

### NOTICE

Improper pipe expanding is the main cause of refrigerant leakage. Please expand the pipe according to the following steps:

### A: Cut the pipe

- Confirm the pipe length according to the distance of indoor unit and outdoor unit.
- Cut the required pipe with pipe cutter.

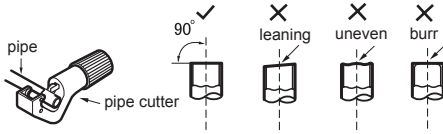

### B: Remove the burrs

- Remove the burrs with shaper and prevent the burrs from getting into the pipe.

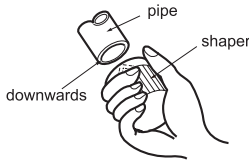

### C: Put on suitable insulating pipe

### D: Put on the union nut

- Remove the union nut on the indoor connection pipe and outdoor valve; install the union nut on the pipe.

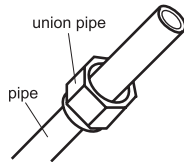

### E: Expand the port

- Expand the port with expander.

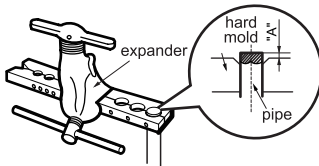

### NOTICE

- "A" is different according to the diameter, please refer to the sheet below:

Outer diameter (mm)	A(mm)	
	Max	Min
Φ6 - 6.35(1/4")	1.3	0.7
Φ9 - 9.52(3/8")	1.6	1.0
Φ12-12.7(1/2")	1.8	1.0
Φ15.8-16(5/8")	2.4	2.2

### F: Inspection

- Check the quality of expanding port. If there is any blemish, expand the port again according to the steps above.

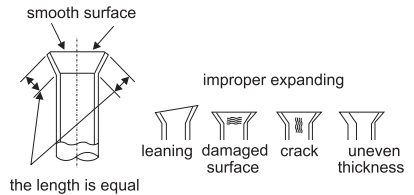

### Working temperature range

	Indoor side DB/WB(°C /°F)	Outdoor side DB/WB(°C /°F)
Maximum cooling	26.7/19.4 (80/67)	50/24 (122/75)
Maximum heating	26.7/- (80/-)	30/18 (86/65)

### NOTE

- The operating temperature range (indoor temperature):  
Cooling unit: 16°C(61°F)~40°C(104°F).  
Heat pump unit: for cooling mode is 16°C(61°F)~40°C(104°F);  
for heating mode is 5°C(41°F)~30°C(86°F).

### **Aptitude requirement for maintenance man(repairs should be done only be specialists).**

- a. Any person who is involved with working on or breaking into a refrigerant circuit should hold a current valid certificate from an industry-accredited assessment authority, which authorises their competence to handle refrigerants safely in accordance with an industry recognised assessment specification.
- b. Servicing shall only be performed as recommended by the equipment manufacturer. Maintenance and repair requiring the assistance of other skilled personnel shall be carried out under the supervision of the person competent in the use of flammable refrigerants.

Pipe-work including piping material, pipe routing, and installation shall include protection from physical damage in operation and service, and be in compliance with national and local codes and standards, such as ASHRAE 15, ASHRAE 15.2, IAPMO Uniform Mechanical Code, ICC International Mechanical Code, or CSA B52. All field joints shall be accessible for inspection prior to being covered or enclosed.

#### • Checks to the area

Prior to beginning work on systems containing flammable refrigerants, safety checks are necessary to ensure that the risk of ignition is minimised. For repair to the refrigerating system, the following precautions shall be complied with prior to conducting work on the system.

#### • Work procedure

Work shall be undertaken under a controlled procedure so as to minimise the risk of a flammable gas or vapour being present while the work is being performed.

#### • General work area

All maintenance staff and others working in the local area shall be instructed on the nature of work being carried out. Work in confined spaces shall be avoided.

#### • Checking for presence of refrigerant

The area shall be checked with an appropriate refrigerant detector prior to and during work, to ensure the technician is aware of potentially toxic or flammable atmospheres. Ensure that the leak detection equipment being used is suitable for use with all applicable refrigerants, i.e. non-sparking adequately sealed or intrinsically safe.

#### • Presence of fire extinguisher

If any hot work is to be conducted on the refrigerating equipment or any associated parts, appropriate fire extinguishing equipment shall be available to hand. Have a dry powder or CO<sub>2</sub> fire extinguisher adjacent to the charging area.

#### • No ignition sources

No person carrying out work in relation to a refrigerating system which involves exposing any pipe work shall use any sources of ignition in such a manner that it may lead to the risk of fire or explosion. All possible ignition sources, including cigarette smoking, should be kept sufficiently far away from the site of installation, repairing, removing and disposal, during which refrigerant can possibly be released to the surrounding space. Prior to work taking place, the area around the equipment is to be surveyed to make sure that there are no flammable hazards or ignition risks. "No Smoking" signs shall be displayed.

#### • Ventilated area

Ensure that the area is in the open or that it is adequately ventilated before breaking into the system or conducting any hot work. A degree of ventilation shall continue during the period that the work is carried out. The ventilation should safely disperse any released refrigerant and preferably expel it externally into the atmosphere.

#### • Checks to the refrigerating equipment

Where electrical components are being changed, they shall be fit for the purpose and to the correct specification. At all times the manufacturer's maintenance and service guidelines shall be followed. If in doubt, consult the manufacturer's technical department for assistance.

The following checks shall be applied to installations using flammable refrigerants:

- the actual refrigerant charge is in accordance with the room size within which the refrigerant containing parts are installed;
- the ventilation machinery and outlets are operating adequately and are not obstructed;
- if an indirect refrigerating circuit is being used, the secondary circuit shall be checked for the presence of refrigerant;
- marking to the equipment continues to be visible and legible. Markings and signs that are illegible shall be corrected;
- refrigerating pipe or components are installed in a position where they are unlikely to be exposed to any substance which may corrode refrigerant containing components, unless the components are constructed of materials which are inherently

resistant to being corroded or are suitably protected against being so corroded.

- **Checks to electrical devices**

Repair and maintenance to electrical components shall include initial safety checks and component inspection procedures. If a fault exists that could compromise safety, then no electrical supply shall be connected to the circuit until it is satisfactorily dealt with. If the fault cannot be corrected immediately but it is necessary to continue operation, an adequate temporary solution shall be used. This shall be reported to the owner of the equipment so all parties are advised.

Initial safety checks shall include:

- that capacitors are discharged: this shall be done in a safe manner to avoid possibility of sparking;
- that no live electrical components and wiring are exposed while charging, recovering or purging the system;
- that there is continuity of earth bonding.

- **Repairs to sealed components**

Sealed electrical components shall be replaced.

- **Repair to intrinsically safe components**

Intrinsically safe components must be replaced.

- **Cabling**

Check that cabling will not be subject to wear, corrosion, excessive pressure, vibration, sharp edges or any other adverse environmental effects. The check shall also take into account the effects of aging or continual vibration from sources such as compressors or fans.

- **Detection of flammable refrigerants**

Under no circumstances shall potential sources of ignition be used in the searching for or detection of refrigerant leaks. A halide torch (or any other detector using a naked flame) shall not be used.

The following leak detection methods are deemed acceptable for all refrigerant systems.

Electronic leak detectors may be used to detect refrigerant leaks but, in the case of flammable refrigerants, the sensitivity may not be adequate, or may need re-calibration. (Detection equipment shall be calibrated in a refrigerant-free area.) Ensure that the detector is not a potential source of ignition and is suitable for the refrigerant used. Leak detection equipment shall be set at a percentage of the LFL of the refrigerant and shall be calibrated to the refrigerant employed, and the appropriate percentage of gas (25% maximum) is confirmed.

Leak detection fluids are also suitable for use with

most refrigerants but the use of detergents containing chlorine shall be avoided as the chlorine may react with the refrigerant and corrode the copper pipe-work.

NOTE: Examples of leak detection fluids are

- bubble method,
- fluorescent method agents.

If a leak is suspected, all naked flames shall be removed/extinguished.

If a leakage of refrigerant is found which requires brazing, all of the refrigerant shall be recovered from the system, or isolated (by means of shut off valves) in a part of the system remote from the leak. Removal of refrigerant shall be according to clause Removal and evacuation.

- **Removal and evacuation**

When breaking into the refrigerant circuit to make repairs – or for any other purpose – conventional procedures shall be used. However, for flammable refrigerants it is important that best practice be followed, since flammability is a consideration. The following procedure shall be adhered to:

- safely remove refrigerant following local and national regulations;
  - evacuate;
  - purge the circuit with inert gas (optional for A2L);
  - evacuate (optional for A2L);
  - continuously flush or purge with inert gas when using flame to open circuit; and
  - open the circuit.

The refrigerant charge shall be recovered into the correct recovery cylinders if venting is not allowed by local and national codes. For appliances containing flammable refrigerants, the system shall be purged with oxygen-free nitrogen to render the appliance safe for flammable refrigerants. This process might need to be repeated several times. Compressed air or oxygen shall not be used for purging refrigerant systems.

For appliances containing flammable refrigerants, refrigerants purging shall be achieved by breaking the vacuum in the system with oxygen-free nitrogen and continuing to fill until the working pressure is achieved, then venting to atmosphere, and finally pulling down to a vacuum (optional for A2L). This process shall be repeated until no refrigerant is within the system (optional for A2L). When the final oxygen-free nitrogen charge is used, the system shall be vented down to atmospheric pressure to enable work to take place.

The outlet for the vacuum pump shall not be close to any potential ignition sources, and ventilation shall be available.

## • Charging procedures

In addition to conventional charging procedures, the following requirements shall be followed.

– Ensure that contamination of different refrigerants does not occur when using charging equipment. Hoses or lines shall be as short as possible to minimise the amount of refrigerant contained in them.

– Cylinders shall be kept in an appropriate position according to the instructions.

– Ensure that the refrigerating system is earthed prior to charging the system with refrigerant.

– Label the system when charging is complete (if not already).

– Extreme care shall be taken not to overfill the refrigerating system.

Prior to recharging the system, it shall be pressure-tested with the appropriate purging gas. The system shall be leak-tested on completion of charging but prior to commissioning. A follow up leak test shall be carried out prior to leaving the site.

## • Decommissioning

Before carrying out this procedure, it is essential that the technician is completely familiar with the equipment and all its detail. It is recommended good practice that all refrigerants are recovered safely. Prior to the task being carried out, an oil and refrigerant sample shall be taken in case analysis is required prior to re-use of recovered refrigerant. It is essential that electrical power is available before the task is commenced.

a) Become familiar with the equipment and its operation.

b) Isolate system electrically.

c) Before attempting the procedure, ensure that:

- mechanical handling equipment is available, if required, for handling refrigerant cylinders;
- all personal protective equipment is available and being used correctly;
- the recovery process is supervised at all times by a competent person;
- recovery equipment and cylinders conform to the appropriate standards.

d) Pump down refrigerant system, if possible.

e) If a vacuum is not possible, make a manifold so that refrigerant can be removed from various parts of the system.

f) Make sure that cylinder is situated on the scales before recovery takes place.

g) Start the recovery machine and operate in accordance with instructions.

h) Do not overfill cylinders. (No more than 80% volume liquid charge).

i) Do not exceed the maximum working pressure of the cylinder, even temporarily.

j) When the cylinders have been filled correctly and the process completed, make sure that the cylinders and the equipment are removed from site promptly and all isolation valves on the equipment are closed off.

k) Recovered refrigerant shall not be charged into another refrigerating system unless it has been cleaned and checked.

## • Labelling

Equipment shall be labelled stating that it has been de-commissioned and emptied of refrigerant. The label shall be dated and signed. For appliances containing flammable refrigerants, ensure that there are labels on the equipment stating the equipment contains flammable refrigerant.

## • Recovery

When removing refrigerant from a system, either for servicing or decommissioning, it is recommended good practice that all refrigerants are removed safely.

When transferring refrigerant into cylinders, ensure that only appropriate refrigerant recovery cylinders are employed. Ensure that the correct number of cylinders for holding the total system charge are available. All cylinders to be used are designated for the recovered refrigerant and labelled for that refrigerant (i.e. special cylinders for the recovery of refrigerant). Cylinders shall be complete with pressure-relief valve and associated shut-off valves in good working order. Empty recovery cylinders are evacuated and, if possible, cooled before recovery occurs.

The recovery equipment shall be in good working order with a set of instructions concerning the equipment that is at hand and shall be suitable for the recovery of the flammable refrigerant. If in doubt, the manufacturer should be consulted. In addition, a set of calibrated weighing scales shall be available and in good working order. Hoses shall be complete with leak-free disconnect couplings and in good condition.

The recovered refrigerant shall be processed according to local legislation in the correct recovery cylinder, and the relevant waste transfer note arranged. Do not mix refrigerants in recovery units and especially not in cylinders.

If compressors or compressor oils are to be removed, ensure that they have been evacuated

to an acceptable level to make certain that flammable refrigerant does not remain within the lubricant. The compressor body shall not be heated by an open flame or other ignition sources to accelerate this process. When oil is drained from a system, it shall be carried out safely.

### **Transportation, marking and storage for units** **Transport of equipment containing flammable refrigerants.**

Attention is drawn to the fact that additional transportation regulations may exist with respect to equipment containing flammable gas. The maximum number of pieces of equipment or the configuration of the equipment permitted to be transported together will be determined by the applicable transport regulations.

### **Marking of equipment using signs**

Signs for similar appliances used in a work area are generally addressed by local regulations and give the minimum requirements for the provision of safety and/or health signs for a work location.

All required signs are to be maintained and employers should ensure that employees receive suitable and sufficient instruction and training on the meaning of appropriate safety signs and the actions that need to be taken in connection with these signs.

The effectiveness of signs should not be diminished by too many signs being placed together.

Any pictograms used should be as simple as possible and contain only essential details.

### **Disposal of equipment using flammable refrigerants**

See national regulations.

### **Storage of equipment/appliances**

The storage of the appliance should be in accordance with the applicable regulations or instructions, whichever is more stringent.

Avoid other heat sources or direct sun light.

Avoid a place where is possible for inflammable gas to leak out.

### **Storage of packed (unsold) equipment**

Storage package protection should be constructed such a way that mechanical damage to the equipment inside the package will not cause a leak of the REFRIGERANT CHARGE.

The maximum number of pieces of equipment permitted to be stored together will be determined by local regulations.

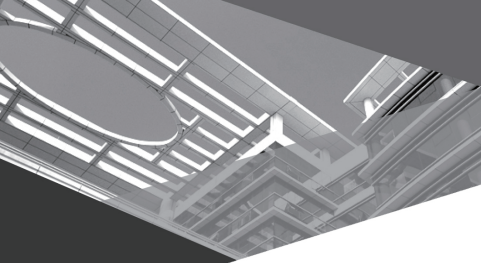

66139911819