

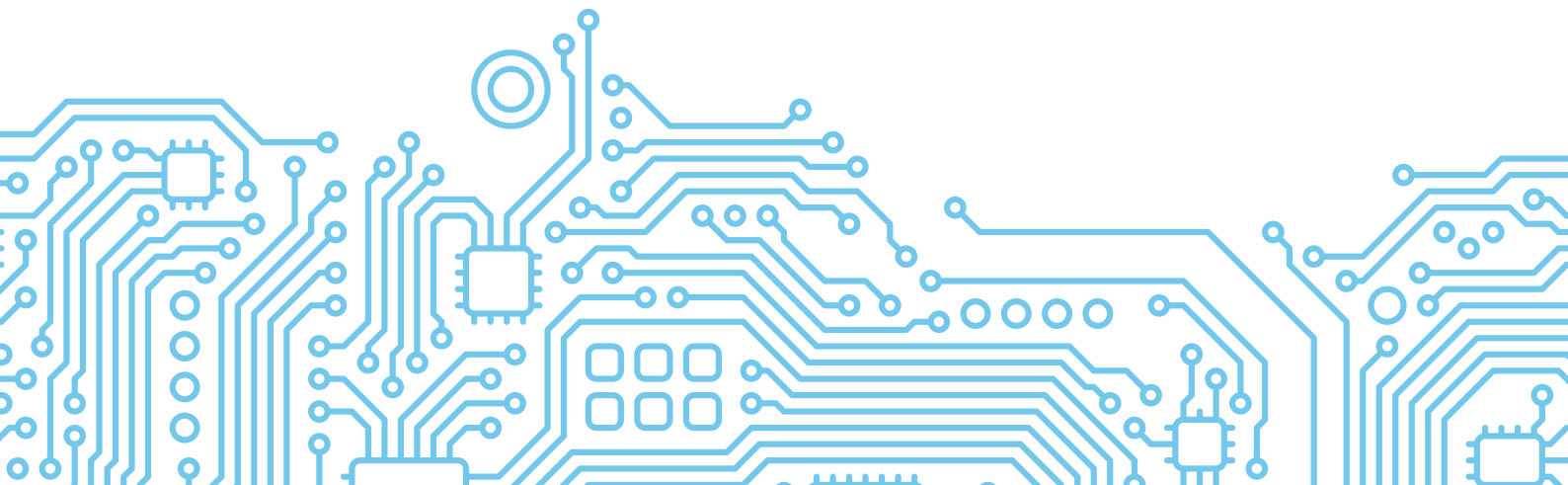

SM_AHU(GA)_R454B_3D INV_US1_NA_2406

AIR HANDLER 3D INVERTER SERIES

SERVICE MANUAL





A2L

Table of Contents

1. Safety Precautions

1. Precautions
2. Information servicing

2. Model Reference & External Appearance

1. Model Reference
2. External Appearance

3. Indoor Unit

1. Feature
2. Dimensional Drawings
3. Part names
4. Service Place
5. Accessories
6. Fan Performance
7. Sound Pressure Levels
8. Refrigerant System Diagram
9. Electrical Characteristics
10. Electrical Wiring Diagrams

4. Installation

5. Product Features

6. Troubleshooting

1. Safety Caution
2. General Troubleshooting
3. Information Inquiry
4. Error Diagnosis and Troubleshooting Without Error Code
5. Quick Maintenance by Error Code
6. Troubleshooting by Error Code
7. Check Procedures

Appendix

- i) Temperature Sensor Resistance Value Table for TP (°C – K)
- ii) Other Temperature Sensors Resistance Value Table (°C – K)
- iii) Pressure On Service Port

Safety Precautions

Contents

1.	Precautions.....	2
2.	Information servicing(For flammable materials).....	4

1. Precautions

To prevent personal injury, or property or unit damage, adhere to all precautionary measures and instructions outlined in this manual. Before servicing a unit, refer to this service manual and its relevant sections.

Failure to adhere to all precautionary measures listed in this section may result in personal injury, damage to the unit or to property, or in extreme cases, death.

 **WARNING** indicates a potentially hazardous situation which if not avoided could result in serious personal injury, or death.

 **CAUTION** indicates a potentially hazardous situation which if not avoided could result in minor or moderate personal injury, or unit damage.

ELECTRICAL WARNING

- Only use the specified wire. If the wire is damaged, it must be replaced by the manufacturer, its service agent or similarly qualified persons in order to avoid a hazard.
- The product must be properly grounded at the time of installation, or electric shock may occur.
- For all electrical work, follow all local and national wiring standards, regulations, and the Installation Manual. Connect cables tightly, and clamp them securely to prevent external forces from damaging the terminal. Improper electrical connections can overheat and cause fire, and may also cause shock. All electrical connections must be made according to the Electrical Connection Diagram located on the panels of the indoor and outdoor units.
- All wiring must be properly arranged to ensure that the control board cover can close properly. If the control board cover is not closed properly, it can lead to corrosion and cause the connection points on the terminal to heat up, catch fire, or cause electrical shock.
- Disconnection must be incorporated in the fixed wiring in accordance with the NEC, CEC or local codes.
- Do not share the electrical outlet with other appliances. Unit must be installed on dedicated electrical circuit.

WARNINGS FOR PRODUCT INSTALLATION

- Turn off the air conditioner and disconnect the power before performing any installation or repairs. Failure to do so can cause electric shock.
- Installation must be performed by an authorized dealer or specialist according to the installation instructions. Improper installation can cause water damage, electrical hazard or fire. Contact an authorized service technician for repair or maintenance.
- This appliance shall be installed in accordance with national wiring regulations. Only use the included accessories, parts, and specified parts for installation.
- Using non-standard parts can cause water leakage, electrical shock, fire, and can cause the unit to fail.
- Install the unit in a firm location that can support the unit's weight. If the chosen location cannot support the unit's weight, or the installation is not done properly, the unit may drop and cause serious injury and damage.
- Install drainage piping according to the instructions in this manual. Improper drainage may cause water damage to your home and property.
- For units that have an auxiliary electric heater, do not install the unit within 1 meter (3 feet) of any combustible materials.
- For the units that have a wireless network function, the USB device access, replacement, maintenance operations must be carried out by professional staff.
- Do not install the unit in a location that may be exposed to combustible gas leaks. If combustible gas accumulates around the unit, it may cause fire.
- Do not turn on the power until all work has been completed.
- When moving or relocating the air conditioner, consult experienced service technicians for disconnection and reinstallation of the unit.

WARNINGS FOR CLEANING AND MAINTENANCE

- Turn off the device and disconnect the power before cleaning. Failure to do so can cause electrical shock.
- Do not clean the air conditioner with excessive amounts of water.
- Do not clean the air conditioner with combustible cleaning agents. Combustible cleaning agents can cause fire or deformation.

WARNING FOR USING FLAMMABLE REFRIGERANT

1. Installation (Space)

- That the installation of pipe-work shall be kept to a minimum.
- That pipe-work shall be protected from physical damage.
- Where refrigerant pipes shall be compliance with national gas regulations.
- That mechanical connections shall be accessible for maintenance purposes.
- In cases that require mechanical ventilation, ventilation openings shall be kept clear of obstruction.
- When disposing of the product is used, be based on national regulations, properly processed.

2. Servicing

- Any person who is involved with working on or breaking into a refrigerant circuit should hold a current valid certificate from an industry-accredited assessment authority, which authorise their competence to handle refrigerants safely in accordance with an industry recognized assessment specification.

3. Maintenance and repair requiring the assistance of other skilled personnel shall be carried out under the supervision of the person competent in the use of flammable refrigerants.

4. Do not use any means to accelerate the defrosting process or to clean, other than those recommended by the manufacturer.

5. The appliance shall be stored in a room without continuously operating ignition sources (for example: open flames, an operating gas appliance or an operating electric heater).

6. Be more careful that foreign matter(oil, water,etc) does not enter the piping.

Also, when storing the piping, securely seal the opening by pinching, taping, etc.

7. Do not pierce or burn.

8. Be aware that refrigerants may not contain an odor.

9. All working procedure that affects safety means shall only be carried by competent persons.

10. Appliance shall be stored in a well ventilated area where the room size corresponds to the room area as specific for operation.

11. The appliance shall be stored so as to prevent mechanical damage from occurring.

12. Joints shall be tested with detection equipment with a capability of 5 g/year of refrigerant or better, with the equipment in standstill and under operation or under a pressure of at least these standstill or operation conditions after installation. Detachable joints shall NOT be used in the indoor side of the unit (brazed, welded joint could be used).

2. Information servicing(For flammable materials)

2.1 Installation(where refrigerant pipes are allowed)

- Any person who is involved with working on or breaking into a refrigerant circuit should hold a current valid certificate from an industry-accredited assessment authority, which authorizes their competence to handle refrigerants safely in accordance with an industry recognized assessment specification.
- Maintenance and repair requiring the assistance of other skilled personnel shall be carried out under the supervision of the person competent in the use of flammable refrigerants.
- That the installation of pipe-work shall be kept to a minimum.
- That pipe-work shall be protected from physical damage.
- Where refrigerant pipes shall be compliance with national gas regulations.
- That mechanical connections shall be accessible for maintenance purposes.
- Be more careful that foreign matter(oil, water,etc) does not enter the piping. Also, when storing the piping, securely seal the opening by pinching, taping, etc.
- All working procedure that affects safety means shall only be carried by competent persons.
- Appliance shall be stored in a well ventilated area where the room size corresponds to the room area as specified for operation.
- Joints shall be tested with detection equipment with a capability of 5 g/year of refrigerant or better, with the equipment in standstill and under operation or under a pressure of at least these standstill or operation conditions after installation. Detachable joints shall NOT be used in the indoor side of the unit(brazed, welded joint could be used).
- In cases that require mechanical ventilation, ventilation openings shall be kept clear of obstruction.
- LEAK DETECTION SYSTEM installed. Unit must be powered except for service.

For the unit with refrigerant sensor, when the refrigerant sensor detects refrigerant leakage, the indoor unit will display a error code and emit a buzzing sound, the compressor of outdoor unit will immediately stop, and the indoor fan will start running. The service life of the refrigerant sensor is 15 years. When the refrigerant sensor

malfunctions, the indoor unit will display the error code "FHCC".

The refrigerant sensor can not be repaired and can only be replaced by the manufacturer. It shall only be replaced with the sensor specified by the manufacturer.

2.2 When a FLAMMABLE REFRIGERANT is used,

the requirements for installation space of appliance and/or ventilation requirements are determined according to

- the mass charge amount(M) used in the appliance,
- the installation location,
- the type of ventilation of the location or of the appliance.
- piping material, pipe routing, and installation shall include protection from physical damage in operation and service, and be in compliance with national and local codes and standards, such as ASHRAE 15, IAPMO Uniform Mechanical Code, ICC International Mechanical Code, or CSA B52. All field joints shall be accessible for inspection prior to being covered or enclosed.
- that protection devices, piping, and fittings shall be protected as far as possible against adverse environmental effects, for example, the danger of water collecting and freezing in relief pipes or the accumulation of dirt and debris;
- that piping in refrigeration systems shall be so designed and installed to minimize the likelihood of hydraulic shock damaging the system;
- that steel pipes and components shall be protected against corrosion with a rustproof coating before applying any insulation;
- that precautions shall be taken to avoid excessive vibration or pulsation;
- the minimum floor area of the room shall be mentioned in the form of a table or a single figure without reference to a formula;
- after completion of field piping for split systems, the field pipework shall be pressure tested with an inert gas and then vacuum tested prior to refrigerant charging, according to the following requirements:

a. The minimum test pressure for the low side of the system shall be the low side design pressure and the minimum test pressure for the high side of the system shall be the high side design pressure, unless the high side of the system can not be isolated from the low side of the system in which case the entire system shall be pressure tested to the low side design pressure.

b. The test pressure after removal of pressure source shall be maintained for at least 1 h with no decrease of pressure indicated by the test gauge, with test gauge resolution not exceeding 5% of the test pressure.

c. During the evacuation test, after achieving a vacuum level specified in the manual or less, the refrigeration system shall be isolated from the vacuum pump and the pressure shall not rise above 1500 microns within 10 min. The vacuum pressure level shall be specified in the manual, and shall be the lessor of 500 microns or the value required for compliance with national and local codes and standards, which may vary between residential, commercial, and industrial buildings.

- field-made refrigerant joints indoors shall be tightness tested according to the following requirements: The test method shall have a sensitivity of 5 grams per year of refrigerant or better under a pressure of at least 0.25 times the maximum allowable pressure. No leak shall be detected.

2.3 Qualification of workers

Any maintenance, service and repair operations must be required qualification of the working personnel. Every working procedure that affects safety means shall only be carried out by competent persons that joined the training and achieved competence should be documented by a certificate. The training of these procedures is carried out by national training organizations or manufacturers that are accredited to teach the relevant national competency standards that may be set in legislation. All training shall follow the ANNEX HH requirements of UL 60335-2-40 4th Edition.

Examples for such working procedures are:

- breaking into the refrigerating circuit;
- opening of sealed components;
- opening of ventilated enclosures.

2.4 Checks to the area

- Prior to beginning work on systems containing flammable refrigerants, safety checks are necessary to ensure that the risk of ignition is minimized. For repair to the refrigerating system, the following precautions shall be complied with prior to conducting work on the system.

2.5 Work procedure

- Work shall be undertaken under a controlled procedure so as to minimise the risk of a flammable gas or vapour being present while the work is being performed.

2.6 General work area

- All maintenance staff and others working in the local area shall be instructed on the nature of work being carried out. Work in confined spaces shall be avoided.

2.7 Checking for presence of refrigerant

- The area shall be checked with an appropriate refrigerant detector prior to and during work, to ensure the technician is aware of potentially flammable atmospheres.
- Ensure that the leak detection equipment being used is suitable for use with flammable refrigerants, i.e. no sparking, adequately sealed or intrinsically safe.

2.8 Presence of fire extinguisher

- If any hot work is to be conducted on the refrigeration equipment or any associated parts, appropriate fire extinguishing equipment shall be available to hand. Have a dry powder or CO₂ fire extinguisher adjacent to the charging area.

2.9 No ignition sources

- No person carrying out work in relation to a REFRIGERATING SYSTEM which involves exposing any pipe work shall use any sources of ignition in such a manner that it may lead to the risk of fire or explosion. All possible ignition sources, including cigarette smoking, should be kept sufficiently far away from the site of installation, repairing, removing and disposal, during which refrigerant can possibly be released to the surrounding space. Prior to work taking place, the area around the equipment is to be surveyed to make sure that there are no flammable hazards or ignition risks.
- "No Smoking" signs shall be displayed.

2.10 Ventilated area

- Ensure that the area is in the open or that it is adequately ventilated before breaking into the system or conducting any hot work. A degree of ventilation shall continue during the period that the work is carried out. The ventilation should safely disperse any released refrigerant and preferably expel it externally into the atmosphere.

2.11 Checks to the refrigeration equipment

- Where electrical components are being changed, they shall be fit for the purpose and to the correct specification. At all times the manufacturer's maintenance and service guidelines shall be followed. If in doubt consult the manufacturer's technical department for assistance. The following checks shall be applied to installations using FLAMMABLE REFRIGERANTS:
 - the actual refrigerant charge is in accordance with the room size within which the refrigerant containing parts are installed;
 - the ventilation machinery and outlets are operating

adequately and are not obstructed;

- if an indirect refrigerating circuit is being used, the secondary circuits shall be checked for the presence of refrigerant;
- marking to the equipment continues to be visible and legible, marking and signs that are illegible shall be corrected;
- refrigeration pipe or components are installed in a position where they are unlikely to be exposed to any substance which may corrode refrigerant containing components, unless the components are constructed of materials which are inherently resistant to being corroded or are suitably protected against being so corroded.

2.12 Checks to electrical devices

- Repair and maintenance to electrical components shall include initial safety checks and component inspection procedures. If a fault exists that could compromise safety, then no electrical supply shall be connected to the circuit until it is satisfactorily dealt with. If the fault cannot be corrected immediately but it is necessary to continue operation, an adequate temporary solution shall be used. This shall be reported to the owner of the equipment so all parties are advised.

Initial safety checks shall include:

- that capacitors are discharged: this shall be done in a safe manner to avoid possibility of sparking;
- that there no live electrical components and wiring are exposed while charging, recovering or purging the system;
- that there is continuity of earth bonding;
- Sealed electrical components shall be replaced if it's damage;
- Intrinsically safe components must be replaced if it's damage.

2.13 Wiring

- Check that wiring will not be subject to wear, corrosion, excessive pressure, vibration, sharp edges or any other adverse environmental effects. The check shall also take into account the effects of aging or continual vibration from sources such as compressors or fans.

2.14 Detection of flammable refrigerants

- Under no circumstances shall potential sources of ignition be used in the searching for or detection of refrigerant leaks. A halide torch(or any other detector using a naked flame) shall not be used.
- The following leak detection methods are deemed acceptable for refrigerant systems. Electronic leak detectors may be used to detect refrigerant leaks but, in the case of FLAMMABLE REFRIGERANTS, the

sensitivity may not be adequate, or may need re-calibration. (Detection equipment shall be calibrated in a refrigerant-free area.) Ensure that the detector is not a potential source of ignition and is suitable for the refrigerant used. Leak detection equipment shall be set at a percentage of the LFL of the refrigerant and shall be calibrated to the refrigerant employed, and the appropriate percentage of gas (25 % maximum) is confirmed.

- Leak detection fluids are also suitable for use with most refrigerants but the use of detergents containing chlorine shall be avoided as the chlorine may react with the refrigerant and corrode the copper pipe-work.

NOTE Examples of leak detection fluids are

- bubble method,

- If a leak is suspected, all naked flames shall be removed/ extinguished.
- If a leakage of refrigerant is found which requires brazing, all of the refrigerant shall be recovered from the system, or isolated (by means of shut of valves) in a part of the system remote from the leak. See the following instructions of removal of refrigerant.

2.15 Removal and evacuation

- When breaking into the refrigerant circuit to make repairs or for any other purpose, conventional procedures shall be used. However, it is important that best practice is followed since flammability is a consideration.
- The following procedure shall be adhered to:
 - safely remove refrigerant following local and national regulations;
 - evacuate;
 - purge the circuit with inert gas(optional for A2L);
 - evacuate(optional for A2L);
 - continuously flush or purge with inert gas when using flame to open circuit; and open the circuit;
- The refrigerant charge shall be recovered into the correct recovery cylinders if venting is not allowed by local and national codes. For appliances containing flammable refrigerants, the system shall be purged with oxygen-free nitrogen to render the appliance safe for flammable refrigerants. This process might need to be repeated several times. Compressed air or oxygen shall not be used for purging refrigerant systems.
- For appliances containing flammable refrigerants, refrigerants purging shall be achieved by breaking the vacuum in the system with oxygen-free nitrogen and continuing to fill until the working pressure is achieved, then venting to atmosphere, and finally pulling down to a vacuum (optional for A2L). This process shall be repeated until no refrigerant is within the system (optional for A2L). When the final oxygen-free nitrogen charge is used, the system shall be vented down to atmospheric pressure to enable work to

take place.

- The outlet for the vacuum pump shall not be close to any potential ignition sources, and ventilation shall be available.

2.16 Charging procedures

- In addition to conventional charging procedures, the following requirements shall be followed:
 - Works shall be undertaken with appropriate tools only (In case of uncertainty, please consult the manufacturer of the tools for use with flammable refrigerants)
 - Ensure that contamination of different refrigerants does not occur when using charging equipment. Hoses or lines shall be as short as possible to minimize the amount of refrigerant contained in them.
 - Cylinders shall be kept upright.
 - Ensure that the refrigeration system is earthed prior to charging the system with refrigerant.
 - Label the system when charging is complete(if not already).
 - Extreme care shall be taken not to overfill the refrigeration system.
 - Prior to recharging the system it shall be pressure tested with oxygen free nitrogen(OFN). The system shall be leak tested on completion of charging but prior to commissioning. A follow up leak test shall be carried out prior to leaving the site.

2.17 Decommissioning

Before carrying out this procedure, it is essential that the technician is completely familiar with the equipment and all its detail. It is recommended good practice that all refrigerants are recovered safely. Prior to the task being carried out, an oil and refrigerant sample shall be taken in case analysis is required prior to re-use of recovered refrigerant. It is essential that electrical power is available before the task is commenced.

- a) Become familiar with the equipment and its operation.
- b) Isolate system electrically
- c) Before attempting the procedure ensure that:
 - mechanical handling equipment is available, if required, for handling refrigerant cylinders;
 - all personal protective equipment is available and being used correctly;
 - the recovery process is supervised at all times by a competent person;
 - recovery equipment and cylinders conform to the appropriate standards.
- d) Pump down refrigerant system, if possible.
- e) If a vacuum is not possible, make a manifold so that refrigerant can be removed from various parts of the system.
- f) Make sure that cylinder is situated on the scales before recovery takes place.

- g) Start the recovery machine and operate in accordance with instructions.
- h) Do not overfill cylinders (no more than 80 % volume liquid charge)
- i) Do not exceed the maximum working pressure of the cylinder, even temporarily.
- j) When the cylinders have been filled correctly and the process completed, make sure that the cylinders and the equipment are removed from site promptly and all isolation valves on the equipment are closed of.
- k) Recovered refrigerant shall not be charged into another refrigeration system unless it has been cleaned and checked.

2.18 Labelling

- Equipment shall be labelled stating that it has been de-commissioned and emptied of refrigerant. The label shall be dated and signed. For appliances containing FLAMMABLE REFRIGERANTS, ensure that there are labels on the equipment stating the equipment contains FLAMMABLE REFRIGERANT.

2.19 Recovery

- When removing refrigerant from a system, either for servicing or decommissioning,
- it is recommended good practice that all refrigerants are removed safely.
- When transferring refrigerant into cylinders, ensure that only appropriate refrigerant recovery cylinders are employed. Ensure that the correct number of cylinders for holding the total system charge is available. All cylinders to be used are designated for the recovered refrigerant and labelled for that refrigerant (i. e. special cylinders for the recovery of refrigerant). Cylinders shall be complete with pressure-relief valve and associated shut-of valves in good working order. Empty recovery cylinders are evacuated and, if possible, cooled before recovery occurs.
- The recovery equipment shall be in good working order with a set of instructions concerning the equipment that is at hand and shall be suitable for the recovery of the flammable refrigerant. If in doubt the manufacturer should be consulted. In addition, a set of calibrated weighing scales shall be available and in good working order. Hoses shall be complete with leak-free disconnect couplings and in good condition.
- The recovered refrigerant shall be processed according to local legislation in the correct recovery cylinder, and the relevant waste transfer note arranged. Do not mix refrigerants in recovery units and especially not in cylinders.
- If compressors or compressor oils are to be removed, ensure that they have been evacuated to an acceptable level to make certain that flammable refrigerant does not remain within the lubricant. The compressor body shall not be heated by an open flame or other ignition sources to accelerate this process. When oil is drained from a system, it shall be carried out safely.

2.20 Unventilated areas

- An unventilated area where the appliance using FLAMMABLE REFRIGERANTS is installed shall be so constructed that should any refrigerant leak, it will not stagnate so as to create a fire or explosion hazard.
- If appliances connected via an air duct system to one or more rooms with A2L REFRIGERANTS are installed in a room with an area less than Amin, that room shall be without continuously operating open flames (e.g. an operating gas appliance) or other POTENTIAL IGNITION SOURCES (for e.g. an operating electric heater, hot surfaces). A flame-producing device may be installed in the same space if the device is provided with an effective flame arrest.
- Auxiliary devices which may be a POTENTIAL IGNITION SOURCE shall not be installed in the duct work. Examples of such POTENTIAL IGNITION SOURCES are hot surfaces with a temperature exceeding 700 °C and electric switching devices.
- Only auxiliary devices (such as certificated heater kit) approved by the appliance manufacturer or declared suitable with the refrigerant shall be installed in connecting ductwork.
- For duct connected appliances, false ceilings or drop ceilings may be used as a return air plenum if a REFRIGERANT DETECTION SYSTEM is provided in the appliance and any external connections are also provided with a sensor immediately below the return air plenum duct joint.
- REFRIGERANT SENSORS for REFRIGERANT DETECTION SYSTEMS Shall Only be replaced with sensors specified by the appliance manufacture.
- LEAK DETECTION SYSTEM installed. Unit must be powered except for service.

2.21 Transportation, marking and storage for units that employ flammable refrigerants

a. General

The following information is provided for units that employ FLAMMABLE REFRIGERANTS.

b. Transport of equipment containing flammable refrigerants

Attention is drawn to the fact that additional transportation regulations may exist with respect to equipment containing flammable gas. The maximum number of pieces of equipment or the configuration of the equipment permitted to be transported together will be determined by the applicable transport regulations.

c. Marking of equipment using signs

Signs for similar appliances used in a work area are generally addressed by local regulations and give the minimum requirements for the provision of safety and/or health signs for a work location.

All required signs are to be maintained and employers should ensure that employees receive suitable and sufficient instruction and training on the meaning of appropriate safety signs and the actions that need to be taken in connection with these signs.

The effectiveness of signs should not be diminished by too many signs being placed together.

Any pictograms used should be as simple as possible and contain only essential details.

d. Disposal of equipment using flammable refrigerants

See national regulations.

e. Storage of equipment/appliances

The storage of the appliance should be in accordance with the applicable regulations or instructions, whichever is more stringent.

f. Storage of packed (unsold) equipment

Storage package protection should be constructed in such a way that mechanical damage to the equipment inside the package will not cause a leak of the REFRIGERANT CHARGE.

The maximum number of pieces of equipment permitted to be stored together will be determined by local regulations.

Model Reference

Contents

1.	Model Reference.....	2
2	External Appearance.....	2

1. Model Reference

	Indoor Unit Model	Capacity (Btu/h)	Power Supply
AHU	MVBC-18HWFN10-MB1	18k	1Phase, 208/230V~, 60Hz
	MVBC-24HWFN10-MB1	24k	
	MVBC-30HWFN10-MC1	30k	
	MVBC-36HWFN10-MC1	36k	
	MVBC-36HWFN10-MC2	36k	
	MVBC-48HWFN10-MD2	48k	
	MVBC-60HWFN10-MD2	60k	

2. External Appearance

2.1 Indoor Unit

Air handler



Indoor Unit-Air Handler

Contents

1.	Feature.....	2
2.	Dimensional Drawings	3
3.	Part names And Functions	4
4.	Service Place.....	5
5.	Accessories	6
6	Fan Performance	7
7.	Sound Pressure Levels	18
8.	Refrigerant System Diagram	21
9.	Electrical Characteristics	22
10.	Electrical Wiring Diagrams.....	22

1. Feature

1.1 Full Multi-position installation

- This AHU is capable of upflow, downflow, horizontal left, or horizontal right configurations.

1.2 Installation Convenience

- It simplifies the airflow volume adjustment process and saves lots of installation efforts. The traditional adjustment method needs the installers to manually set the motor speed, according to the installation instruction and ducting design. It takes lots of time if this thing doesn't go well and decreases the marginal profits.

1.3 Easy Fault Code Checking

- Thanks to advanced mutual data communication technology, the AHU system can intelligently self-detecting the failure cause and generate a corresponding code.
- Installer or user can easily check the fault code displayed on the electric function board by just opening the lid.
- It helps you proactively determine the failure cause, prepare for repairing parts ahead of field maintenance work, greatly improve the work efficiency.

1.4 Automatic Airflow Adjustment

- During the operation, when the dust filter or evaporator is clogged with dust, the load of the system and motor torque increases. The MPU(microprocessor) on the unit can detect this change and adjust the fan speed to keep the CFM stable.

2. Dimensional Drawings

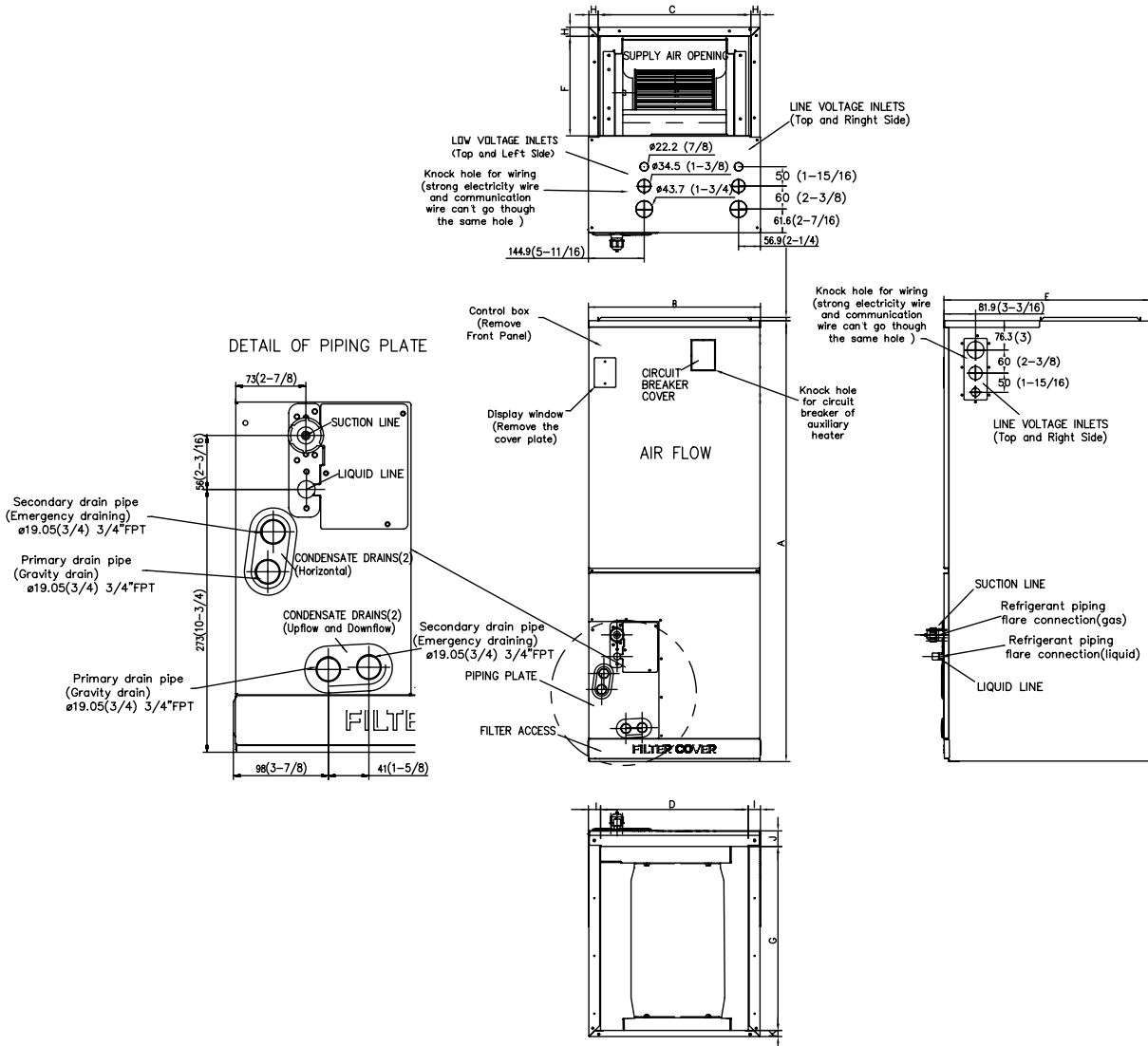

Dimensions	Model	18k/24k		30k/36k		48k/60k	
		inch	mm	inch	mm	inch	mm
A	Model Height	45	1143	49	1245	53	1346
B	Model Width	17-1/2	445	21	534	24-1/2	622
C	Supply Air Opening Width	15-5/8	397	19-1/8	486	22-5/8	575
D	Return Air Opening Width	15-1/8	384	18-5/8	473	22-1/8	562
E	Model Depth	21	534	21	534	21	534
F	Supply Air Opening Depth	10-1/4	260	10-1/4	260	10-1/4	260
G	Return Air Opening Depth	18-3/4	476	18-3/4	476	18-3/4	476
H	Supply Air Opening Clearance	15/16	24	15/16	24	15/16	24
I	Return Air Opening Side Clearance	1-1/4	32	1-1/4	32	1-1/8	28
J	Return Air Opening Front Clearance	1-1/2	38	1-5/8	41	1-5/8	41
K	Return Air Opening Back Clearance	5/8	16	5/8	16	3/4	19

3. Part names And Functions

(1) Vertical

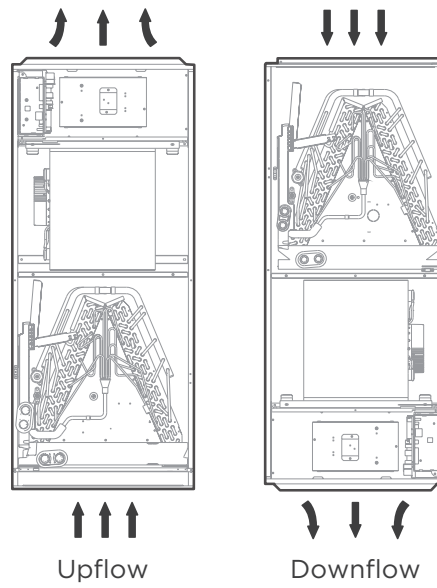

(2) Horizontal Right

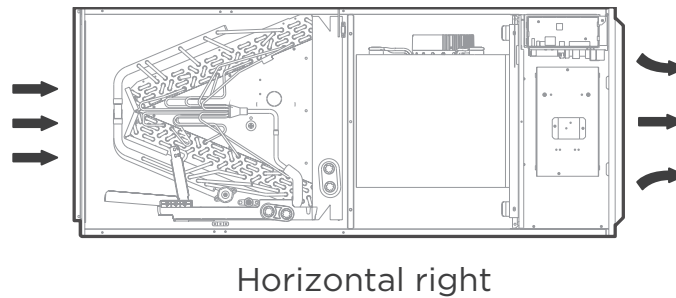

(3) Horizontal Left

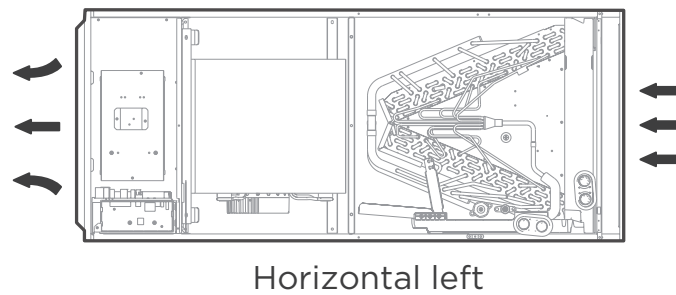

Note: Vertical up and horizontal left installation does not need to change the direction of evaporator.

4. Service Place

The distance between the mounted indoor unit should meet the specifications illustrated in the following diagram.

Horizontal installations

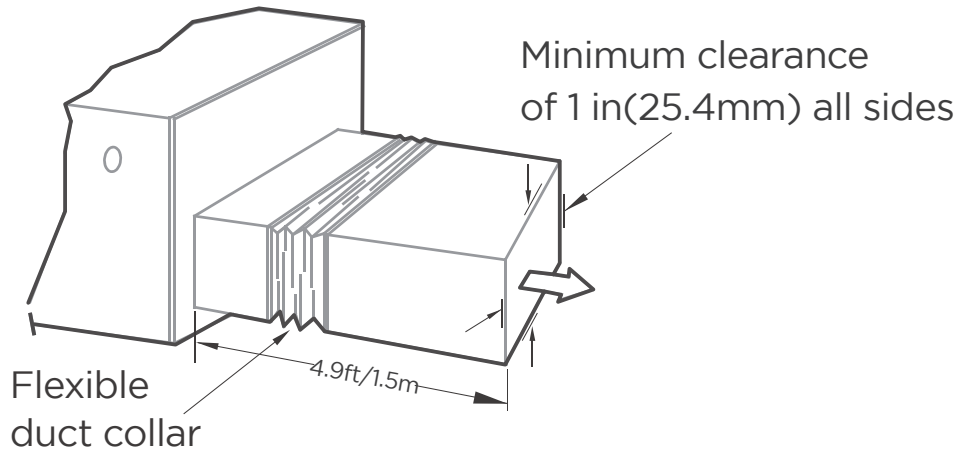





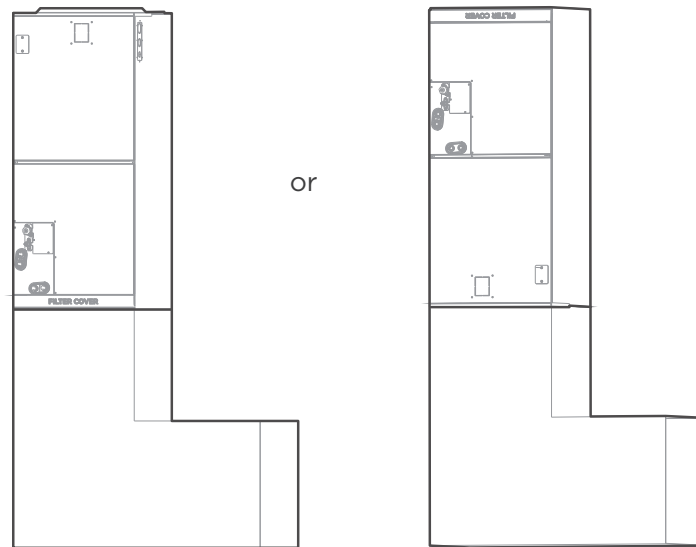



The outlet side pipe length 4.9ft/1.5m.

Vertical installations

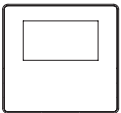

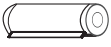
5. Accessories

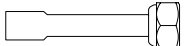
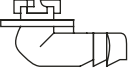
The air conditioning system comes with the following accessories. Use all of the installation parts and accessories to install the air conditioner. Improper installation may result in water leakage, electrical shock and fire, or equipment failure.

Name		Shape	Quantity
Manual			2
Remote controller			1
Battery			2
Wired remote controller			1
Cable ties			6
Insulation sleeve			2
Flare nut			2
Braze to flare adapter			2
Accessories (Packed with the outdoor unit)			
Packed with the outdoor unit	Drain joint		1
	Seal		1

Note: The remote control is only used to adjust the parameters.

Installation of Electric Auxiliary Heat Module (for some models) (not supplied)

Name	Quantity
Manual	2
Foam gasket	1
Screw	7
Silicone breaker cover	1
Electric auxiliary heating wiring diagram	1
Circuit breaker label	1

6. Fan Performance

6.1 18k

Vertical, Horizontal Right, Horizontal Left

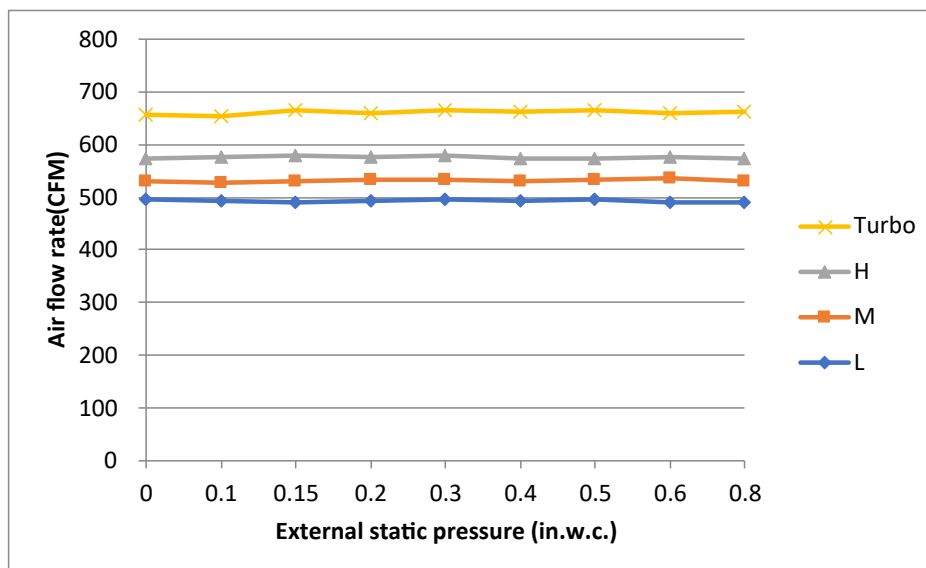

Use the remote controller

1. Indoor unit need to turn off for 5 minutes then power on(all of setting need to finish within 10 minutes)
2. Keep push for 7 seconds with ON/OFF and FAN SPEED together to get in Engineer mode
3. Choose channel 23(for cooling) and 25(for heating) with UP and Down button
4. After choose channel 23 or 25 then keep push ON/OFF for 2 seconds to select -41, -40,....., -1, 0, 1,2,3.....19 20(reference the matrix list to identify the relative CFM)
5. Push the button OK to confirm the adjustment value,the display board will display with CS mean success(for setting),then disconnect power after 5 seconds

Cooling	Default	-1	-2	-3	-4	-5	-6	-7
Turbo	618	598	578	558	538	518	498	478
High	576	556	536	516	496	476	456	436
Medium	529	509	489	469	449	429	418	418
Low	488	468	448	428	408	400	400	400
Cooling	Default	-8	-9 ~ -41	+1	+2	+3	+4	+5 ~ +20
Turbo	618	458	453	635	635	635	635	635
High	576	435	435	596	616	618	618	618
Medium	529	418	418	549	569	589	600	600
Low	488	400	400	508	528	548	568	582

Heating	Default	-1	-2	-3	-4	-5	-6 ~ -41	+1	+2
Turbo	565	545	525	505	485	465	453	585	605
High	541	521	501	481	461	441	435	561	581
Medium	435	418	418	418	418	418	418	455	475
Low	400	400	400	400	400	400	400	420	440
Heating	Default	+3	+4	+5	+6	+7	+8	+9	+10~+20
Turbo	565	625	635	635	635	635	635	635	635
High	541	601	618	618	618	618	618	618	618
Medium	435	495	515	535	555	575	595	600	600
Low	400	460	480	500	520	540	560	580	582

6.2 24k

Vertical, Horizontal Right, Horizontal Left

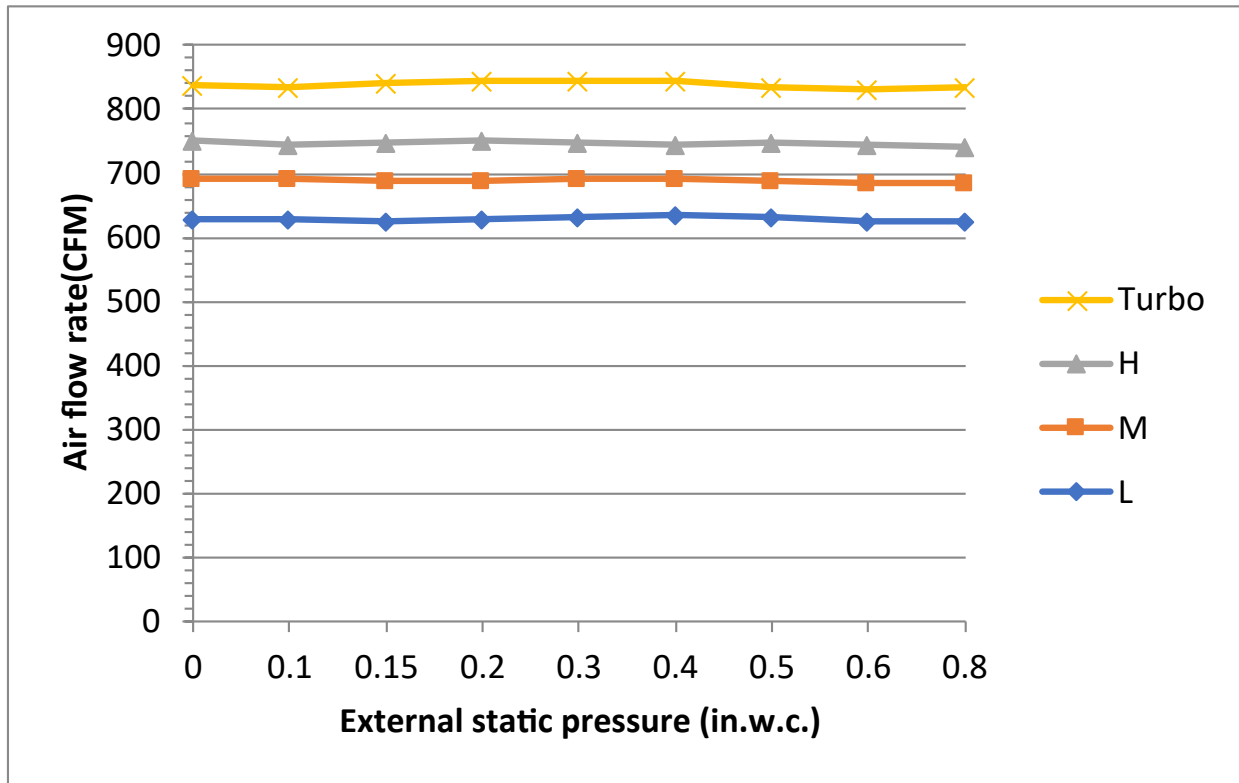

Use the remote controller

1. Indoor unit need to turn off for 5 minutes then power on (all of setting need to finish within 10 minutes)
2. Keep push for 7 seconds with ON/OFF and FAN SPEED together to get in Engineer mode
3. Choose channel 23 (for cooling) and 25 (for heating) with UP and Down button
4. After choose channel 23 or 25 then keep push ON/OFF for 2 seconds to select -41, -40, ..., -1, 0, 1, 2, 3, ..., 19, 20 (reference the matrix list to identify the relative CFM)
5. Push the button OK to confirm the adjustment value, the display board will display with CS mean success (for setting), then disconnect power after 5 seconds

Cooling	Default	-1	-2	-3	-4	-5	-6	-7	-8	-9	-10
Turbo	988	804	784	764	744	724	704	684	664	644	624
High	894	739	719	699	679	659	639	619	599	579	559
Medium	806	674	654	634	614	594	574	554	534	514	494
Low	712	609	589	569	549	529	509	489	469	449	429
Cooling	Default	-11	-12	-13	-14	-15	-16	-17	-18	-19 ~ -41	+1
Turbo	988	604	584	564	544	524	504	484	464	453	844
High	894	539	519	499	479	459	439	435	435	435	779
Medium	806	474	454	434	418	418	418	418	418	418	714
Low	712	409	400	400	400	400	400	400	400	400	649
Cooling	Default	+2	+3	+4	+5	+6	+7	+8	+9 ~ +20		
Turbo	988	853	853	853	853	853	853	853	853		
High	894	799	819	835	835	835	835	835	835		
Medium	806	734	754	774	794	814	818	818	818		
Low	712	669	689	709	729	749	769	789	800		

Heating	Default	-1	-2	-3	-4	-5	-6	-7	-8	-9	-10	-11
Turbo	788	768	748	728	708	688	668	648	628	608	588	568
High	753	733	713	693	673	653	633	613	593	573	553	533
Medium	641	621	601	581	561	541	521	501	481	461	441	421
Low	524	504	484	464	444	424	404	400	400	400	400	400
Heating	Default	-12	-13	-14	-15	-16	-17~-41	+1	+2	+3	+4	+5
Turbo	788	548	528	508	488	468	453	808	828	848	853	853
High	753	513	493	473	453	435	435	773	793	813	833	835
Medium	641	418	418	418	418	418	418	661	681	701	721	741
Low	524	400	400	400	400	400	400	544	564	584	604	624
Heating	Default	+6	+7	+8	+9	+10	+11	+12	+13	+14~+20		
Turbo	788	853	853	853	853	853	853	853	853	853		
High	753	835	835	835	835	835	835	835	835	835		
Medium	641	761	781	801	818	818	818	818	818	818		
Low	524	644	664	684	704	724	744	764	784	800		

6.3 30k

Vertical, Horizontal Right, Horizontal Left

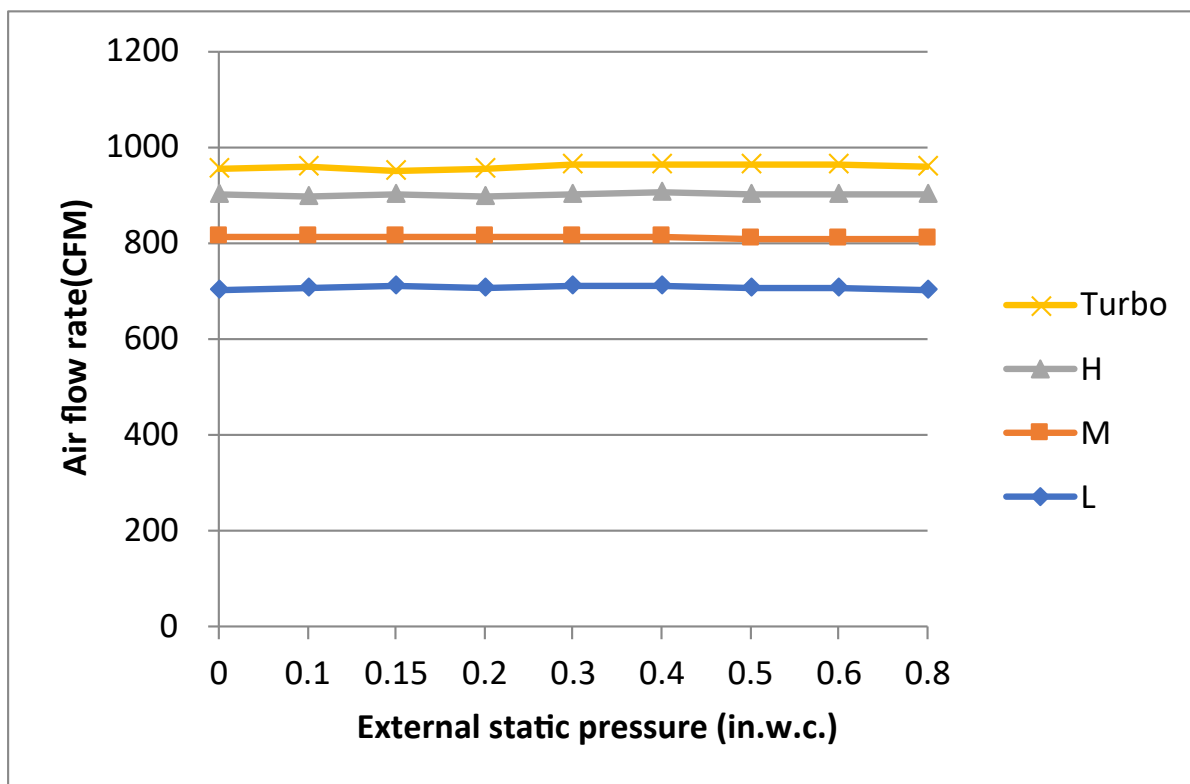

Use the remote controller

1. Indoor unit need to turn off for 5 minutes then power on(all of setting need to finish within 10 minutes)
2. Keep push for 7 seconds with ON/OFF and FAN SPEED together to get in Engineer mode
3. Choose channel 23(for cooling) and 25(for heating) with UP and Down button
4. After choose channel 23 or 25 then keep push ON/OFF for 2 seconds to select -41, -40,....., -1, 0, 1,2,3.....19 20(reference the matrix list to identify the relative CFM)
5. Push the button OK to confirm the adjustment value,the display board will display with CS mean success(for setting),then disconnect power after 5 seconds

Cooling	Default	-1	-2	-3	-4	-5	-6	-7	-8	-9	-10	-11
Turbo	988	968	948	928	908	888	868	848	828	808	788	768
High	894	874	854	834	814	794	774	754	734	714	694	674
Medium	806	786	766	746	726	706	686	666	646	626	606	586
Low	712	692	672	652	632	612	592	572	552	532	512	492
Cooling	Default	-12	-13	-14	-15	-16	-17	-18	-19	-20	-21	-22
Turbo	988	748	728	708	688	668	648	628	608	588	568	548
High	894	654	634	614	594	574	554	534	514	494	474	454
Medium	806	566	546	526	506	486	466	446	426	418	418	418
Low	712	472	452	432	412	400	400	400	400	400	400	400
Cooling	Default	-23	-24	-25	-26	-24-41	+1	+2	+3	+4	+5	+6
Turbo	988	528	508	488	468	453	988	1008	1028	1048	1068	1071
High	894	435	435	435	435	435	894	914	934	954	974	994
Medium	806	418	418	418	418	418	806	826	846	866	886	906
Low	712	400	400	400	400	400	712	732	752	772	792	812

Cooling	Default	+7	+8	+9	+10	+11	+12	+13	+14	+15	+16	+17~+20
Turbo	988	1071	1071	1071	1071	1071	1071	1071	1071	1071	1071	1071
High	894	1014	1034	1053	1053	1053	1053	1053	1053	1053	1053	1053
Medium	806	926	946	966	986	1006	1026	1035	1035	1035	1035	1035
Low	712	832	852	872	892	912	932	952	972	992	1012	1018

Heating	Default	-1	-2	-3	-4	-5	-6	-7	-8	-9	-10
Turbo	918	898	878	858	838	818	798	778	758	738	718
High	876	856	836	816	796	776	756	736	716	696	676
Medium	665	645	625	605	585	565	545	525	505	485	465
Low	453	433	413	400	400	400	400	400	400	400	400

Heating	Default	-11	-12	-13	-14	-15	-16	-17	-18	-19	-20
Turbo	918	698	678	658	638	618	598	578	558	538	518
High	876	656	636	616	596	576	556	536	516	496	476
Medium	665	445	425	418	418	418	418	418	418	418	418
Low	453	400	400	400	400	400	400	400	400	400	400

Heating	Default	-21	-22	-23	-24~-41	+1	+2	+3	+4	+5	+6
Turbo	918	498	478	458	453	938	958	978	998	1018	1038
High	876	456	436	435	435	896	916	936	956	976	996
Medium	665	418	418	418	418	685	705	725	745	765	785
Low	453	400	400	400	400	473	493	513	533	553	573

Heating	Default	+7	+8	+9	+10	+11	+12	+13	+14~+20		
Turbo	918	1058	1071	1071	1071	1071	1071	1071	1071		
High	876	1016	1036	1053	1053	1053	1053	1053	1053		
Medium	665	805	825	845	865	885	905	925	945		
Low	453	593	613	633	653	673	693	713	733		

6.4 36k

Vertical, Horizontal Right, Horizontal Left

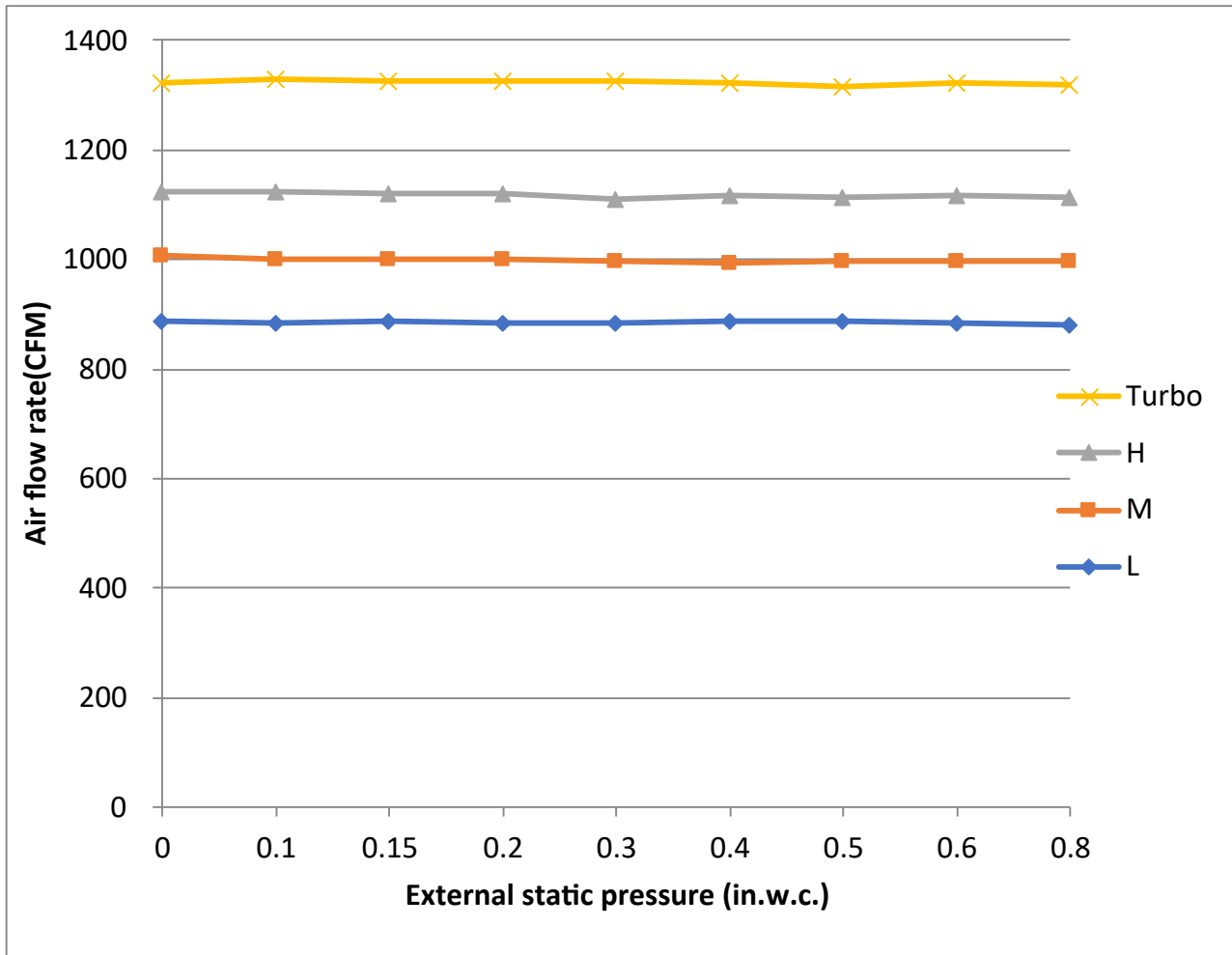

Use the remote controller

1. Indoor unit need to turn off for 5 minutes then power on(all of setting need to finish within 10 minutes)
2. Keep push for 7 seconds with ON/OFF and FAN SPEED together to get in Engineer mode
3. Choose channel 23(for cooling) and 25(for heating) with UP and Down button
4. After choose channel 23 or 25 then keep push ON/OFF for 2 seconds to select -41, -40,....., -1, 0, 1,2,3.....19 20(reference the matrix list to identify the relative CFM)
5. Push the button OK to confirm the adjustment value,the display board will display with CS mean success(for setting),then disconnect power after 5 seconds

Cooling	Default	-1	-2	-3	-4	-5	-6	-7	-8	-9	-10	-11	-12
Turbo	1188	1168	1148	1128	1108	1088	1068	1048	1028	1008	988	968	948
High	1082	1062	1042	1022	1002	982	962	942	922	902	882	862	842
Medium	971	951	931	911	891	871	851	831	811	791	771	751	731
Low	865	845	825	805	785	765	745	725	705	685	665	645	625
Cooling	Default	-13	-14	-15	-16	-17	-18	-19	-20	-21	-22	-23	-24
Turbo	1188	928	908	888	868	848	828	808	788	768	748	728	708
High	1082	822	802	782	762	742	722	702	682	662	642	622	602
Medium	971	711	691	671	651	631	611	591	571	551	531	511	491
Low	865	605	585	565	545	525	505	485	465	445	425	405	400

Cooling	Default	-25	-26	-27	-28	-29	-30	-31	-32	-33	-34	-35	-36
Turbo	1188	688	668	648	628	608	588	568	548	528	508	488	468
High	1082	582	562	542	522	502	482	462	442	435	435	435	435
Medium	971	471	451	431	418	418	418	418	418	418	418	418	418
Low	865	400	400	400	400	400	400	400	400	400	400	400	400
Cooling	Default	-37~-41	+1	+2	+3	+4	+5	+6	+7	+8	+9	+10	+11
Turbo	1188	453	1208	1228	1248	1268	1288	1288	1288	1288	1288	1288	1288
High	1082	435	1102	1122	1142	1162	1182	1202	1222	1242	1262	1271	1271
Medium	971	418	991	1011	1031	1051	1071	1091	1111	1131	1151	1171	1191
Low	865	400	885	905	925	945	965	985	1005	1025	1045	1065	1085
Cooling	Default	+12	+13	+14	+15	+16	+17	+18	+19~+20				
Turbo	1188	1288	1288	1288	1288	1288	1288	1288	1288				
High	1082	1271	1271	1271	1271	1271	1271	1271	1271				
Medium	971	1211	1231	1251	1253	1253	1253	1253	1253				
Low	865	1105	1125	1145	1165	1185	1205	1225	1235				

Heating	Default	-1	-2	-3	-4	-5	-6	-7	-8	-9	-10	-11
Turbo	1112	1092	1072	1052	1032	1012	992	972	952	932	912	892
High	1059	1039	1019	999	979	959	939	919	899	879	859	839
Medium	794	774	754	734	714	694	674	654	634	614	594	574
Low	582	562	542	522	502	482	462	442	422	402	400	400
Heating	Default	-12	-13	-14	-15	-16	-17	-18	-19	-20	-21	-22
Turbo	1112	872	852	832	812	792	772	752	732	712	692	672
High	1059	819	799	779	759	739	719	699	679	659	639	619
Medium	794	554	534	514	494	474	454	434	418	418	418	418
Low	582	400	400	400	400	400	400	400	400	400	400	400
Heating	Default	-23	-24	-25	-26	-27	-28	-29	-30	-31	-32	-33~-41
Turbo	1112	652	632	612	592	572	552	532	512	492	472	453
High	1059	599	579	559	539	519	499	479	459	439	435	435
Medium	794	418	418	418	418	418	418	418	418	418	418	418
Low	582	400	400	400	400	400	400	400	400	400	400	400
Heating	Default	+1	+2	+3	+4	+5	+6	+7	+8	+9	+10	+11
Turbo	1112	1132	1152	1172	1192	1212	1232	1252	1272	1288	1288	1288
High	1059	1079	1099	1119	1139	1159	1179	1199	1219	1239	1259	1271
Medium	794	814	834	854	874	894	914	934	954	974	994	1014
Low	582	602	622	642	662	682	702	722	742	762	782	802
Heating	Default	+12	+13	+14	+15	+16	+17	+18	+19	+20		
Turbo	1112	1288	1288	1288	1288	1288	1288	1288	1288	1288		
High	1059	1271	1271	1271	1271	1271	1271	1271	1271	1271		
Medium	794	1034	1054	1074	1094	1114	1134	1154	1174	1194		
Low	582	822	842	862	882	902	922	942	962	982		

6.5 48k

Vertical, Horizontal Right, Horizontal Left

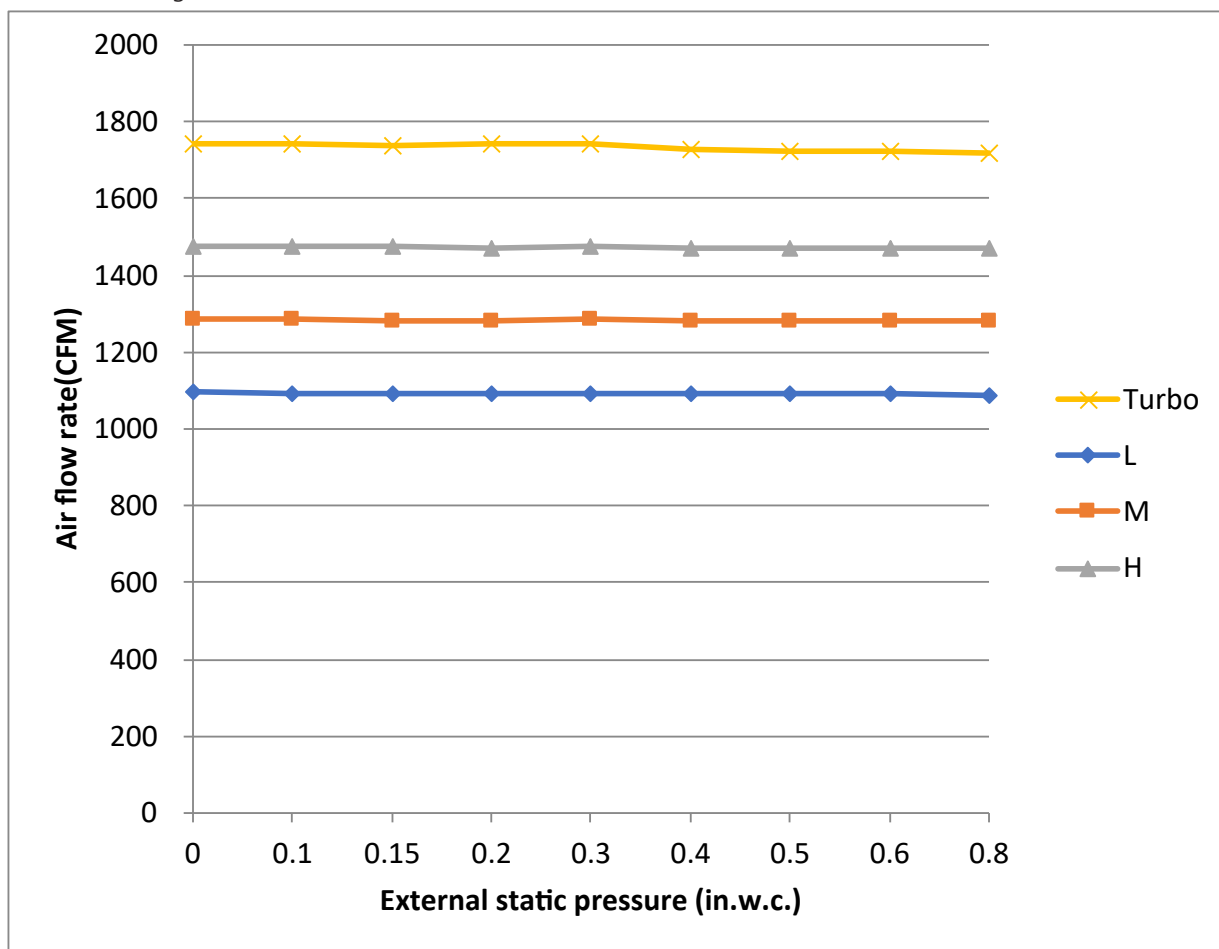

Use the remote controller

1. Indoor unit need to turn off for 5 minutes then power on(all of setting need to finish within 10 minutes)
2. Keep push for 7 seconds with ON/OFF and FAN SPEED together to get in Engineer mode
3. Choose channel 23(for cooling) and 25(for heating) with UP and Down button
4. After choose channel 23 or 25 then keep push ON/OFF for 2 seconds to select -41, -40,....., -1, 0, 1,2,3.....19 20(reference the matrix list to identify the relative CFM)
5. Push the button OK to confirm the adjustment value,the display board will display with CS mean success(for setting),then disconnect power after 5 seconds

Cooling	Default	-1	-2	-3	-4	-5	-6	-7	-8	-9	-10
Turbo	1600	1580	1560	1540	1520	1500	1480	1460	1440	1420	1400
High	1471	1451	1431	1411	1391	1371	1351	1331	1311	1291	1271
Medium	1282	1262	1242	1222	1202	1182	1162	1142	1122	1102	1082
Low	1094	1074	1054	1034	1014	994	974	954	934	914	894
Cooling	Default	-11	-12	-13	-14	-15	-16	-17	-18	-19	-20
Turbo	1600	1380	1360	1340	1320	1300	1280	1260	1240	1220	1200
High	1471	1251	1231	1211	1191	1171	1151	1131	1111	1091	1071
Medium	1282	1062	1042	1022	1002	982	962	942	922	902	882
Low	1094	874	854	834	814	794	774	754	734	714	694
Cooling	Default	-21	-22	-23	-24	-25	-26	-27	-28	-29	-30
Turbo	1600	1180	1160	1140	1120	1100	1080	1060	1040	1020	1000

High	1471	1051	1031	1011	991	971	951	931	911	891	871
Medium	1282	862	842	822	802	782	762	742	722	702	682
Low	1094	486	466	465	465	465	465	465	465	465	465
Cooling	Default	-31	-32	-33	-34	-35	-36	-37	-38	-39	-40~-41
Turbo	1600	980	960	940	920	900	880	860	840	820	800
High	1471	851	831	811	791	771	751	731	711	691	671
Medium	1282	662	642	622	602	582	562	542	522	502	482
Low	1094	465	465	465	465	465	465	465	465	465	465
Cooling	Default	+1	+2	+3	+4	+5	+6	+7	+8	+9	+10
Turbo	1600	1620	1640	1660	1680	1700	1720	1724	1724	1724	1724
High	1471	1491	1511	1531	1551	1571	1591	1611	1631	1651	1671
Medium	1282	1302	1322	1342	1362	1382	1402	1422	1442	1462	1482
Low	1094	1114	1134	1154	1174	1194	1214	1234	1254	1274	1294
Cooling	Default	+11	+12	+13	+14	+15	+16	+17	+18	+19	+20
Turbo	1600	1724	1724	1724	1724	1724	1724	1724	1724	1724	1724
High	1471	1691	1706	1706	1706	1706	1706	1706	1706	1706	1706
Medium	1282	1502	1522	1542	1562	1582	1602	1622	1642	1662	1682
Low	1094	1314	1334	1354	1374	1394	1414	1434	1454	1474	1494

Heating	Default	-1	-2	-3	-4	-5	-6	-7	-8	-9	-10
Turbo	1600	1580	1560	1540	1520	1500	1480	1460	1440	1420	1400
High	1382	1362	1342	1322	1302	1282	1262	1242	1222	1202	1182
Medium	1141	1121	1101	1081	1061	1041	1021	1001	981	961	941
Low	976	956	936	916	896	876	856	836	816	796	776
Heating	Default	-11	-12	-13	-14	-15	-16	-17	-18	-19	-20
Turbo	1600	1380	1360	1340	1320	1300	1280	1260	1240	1220	1200
High	1382	1162	1142	1122	1102	1082	1062	1042	1022	1002	982
Medium	1141	921	901	881	861	841	821	801	781	761	741
Low	976	756	736	716	696	676	656	636	616	596	576
Heating	Default	-21	-22	-23	-24	-25	-26	-27	-28	-29	-30
Turbo	1600	1180	1160	1140	1120	1100	1080	1060	1040	1020	1000
High	1382	962	942	922	902	882	862	842	822	802	782
Medium	1141	721	701	681	661	641	621	601	581	561	541
Low	976	556	536	516	496	476	465	465	465	465	465
Heating	Default	-31	-32	-33	-34	-35	-36	-37	-38	-39	-40~-41
Turbo	1600	980	960	940	920	900	880	860	840	820	800
High	1382	762	742	722	702	682	662	642	622	602	582
Medium	1141	521	501	482	482	482	482	482	482	482	482
Low	976	465	465	465	465	465	465	465	465	465	465
Heating	Default	+1	+2	+3	+4	+5	+6	+7	+8	+9	+10
Turbo	1600	1620	1640	1660	1680	1700	1720	1724	1724	1724	1724
High	1382	1402	1422	1442	1462	1482	1502	1522	1542	1562	1582
Medium	1141	1161	1181	1201	1221	1241	1261	1281	1301	1321	1341
Low	976	996	1016	1036	1056	1076	1096	1116	1136	1156	1176
Heating	Default	+11	+12	+13	+14	+15	+16	+17	+18	+19	+20
Turbo	1600	1724	1724	1724	1724	1724	1724	1724	1724	1724	1724
High	1382	1602	1622	1642	1662	1682	1702	1706	1706	1706	1706
Medium	1141	1361	1381	1401	1421	1441	1461	1481	1501	1521	1541
Low	976	1196	1216	1236	1256	1276	1296	1316	1336	1356	1376

6.6 60k

Vertical, Horizontal Right, Horizontal Left

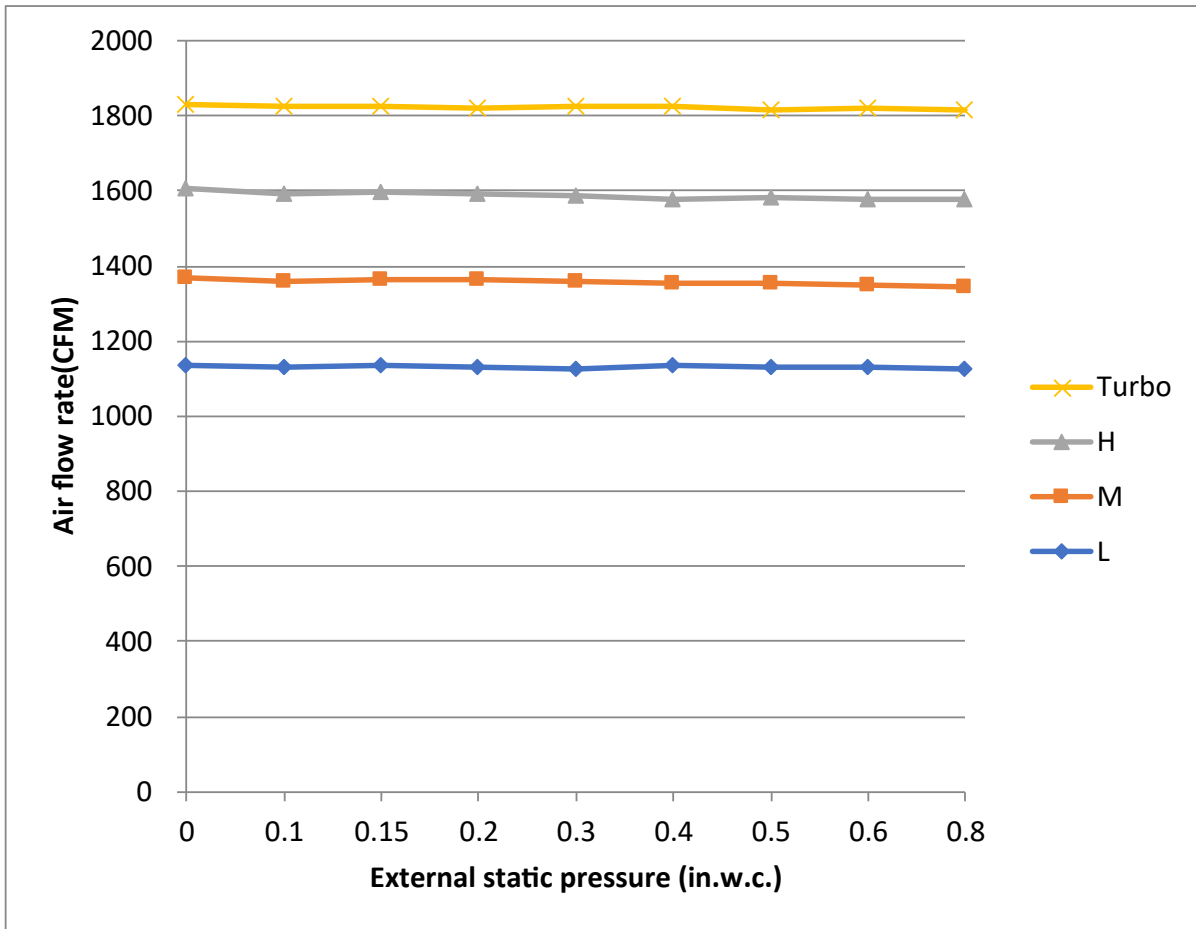

Use the remote controller

1. Indoor unit need to turn off for 5 minutes then power on(all of setting need to finish within 10 minutes)
2. Keep push for 7 seconds with ON/OFF and FAN SPEED together to get in Engineer mode
3. Choose channel 23(for cooling) and 25(for heating) with UP and Down button
4. After choose channel 23 or 25 then keep push ON/OFF for 2 seconds to select -41, -40,....., -1, 0, 1,2,3.....19 20(reference the matrix list to identify the relative CFM)
5. Push the button OK to confirm the adjustment value,the display board will display with CS mean success(for setting),then disconnect power after 5 seconds

Cooling	Default	-1	-2	-3	-4	-5	-6	-7	-8	-9	-10
Turbo	1806	1786	1766	1746	1726	1706	1686	1666	1646	1626	1606
High	1582	1562	1542	1522	1502	1482	1462	1442	1422	1402	1382
Medium	1359	1339	1319	1299	1279	1259	1239	1219	1199	1179	1159
Low	1135	1115	1095	1075	1055	1035	1015	995	975	955	935
Cooling	Default	-11	-12	-13	-14	-15	-16	-17	-18	-19	-20
Turbo	1806	1586	1566	1546	1526	1506	1486	1466	1446	1426	1406
High	1582	1362	1342	1322	1302	1282	1262	1242	1222	1202	1182
Medium	1359	1139	1119	1099	1079	1059	1039	1019	999	979	959
Low	1135	915	895	875	855	835	815	795	775	755	735
Cooling	Default	-21	-22	-23	-24	-25	-26	-27	-28	-29	-30
Turbo	1806	1386	1366	1346	1326	1306	1286	1266	1246	1226	1206

High	1582	1162	1142	1122	1102	1082	1062	1042	1022	1002	982
Medium	1359	939	919	899	879	859	839	819	799	779	759
Low	1135	715	695	694	694	694	694	694	694	694	694
Cooling	Default	-31	-32	-33	-34	-35	-36	-37	-38	-39	-40~-41
Turbo	1806	1186	1166	1146	1126	1106	1086	1066	1046	1026	1006
High	1582	962	942	922	902	882	862	842	822	802	782
Medium	1359	739	719	712	712	712	712	712	712	712	712
Low	1135	694	694	694	694	694	694	694	694	694	694
Cooling	Default	+1	+2	+3	+4	+5	+6	+7	+8	+9	+10
Turbo	1806	1826	1846	1866	1886	1906	1926	1946	1966	1986	2006
High	1582	1602	1622	1642	1662	1682	1702	1722	1742	1762	1782
Medium	1359	1379	1399	1419	1439	1459	1479	1499	1519	1539	1559
Low	1135	1155	1175	1195	1215	1235	1255	1275	1295	1315	1335
Cooling	Default	+11	+12	+13	+14	+15	+16	+17	+18	+19	+20
Turbo	1806	2026	2046	2066	2086	2106	2126	2146	2153	2153	2153
High	1582	1802	1822	1842	1862	1882	1902	1922	1942	1962	1982
Medium	1359	1579	1599	1619	1639	1659	1679	1699	1719	1739	1759
Low	1135	1355	1375	1395	1415	1435	1455	1475	1495	1515	1535

Heating	Default	-1	-2	-3	-4	-5	-6	-7	-8	-9	-10
Turbo	1659	1639	1619	1599	1579	1559	1539	1519	1499	1479	1459
High	1582	1562	1542	1522	1502	1482	1462	1442	1422	1402	1382
Medium	1247	1227	1207	1187	1167	1147	1127	1107	1087	1067	1047
Low	976	956	936	916	896	876	856	836	816	796	776
Heating	Default	-11	-12	-13	-14	-15	-16	-17	-18	-19	-20
Turbo	1659	1439	1419	1399	1379	1359	1339	1319	1299	1279	1259
High	1582	1362	1342	1322	1302	1282	1262	1242	1222	1202	1182
Medium	1247	1027	1007	987	967	947	927	907	887	867	847
Low	976	756	736	716	696	694	694	694	694	694	694
Heating	Default	-21	-22	-23	-24	-25	-26	-27	-28	-29	-30
Turbo	1659	1239	1219	1199	1179	1159	1139	1119	1099	1079	1059
High	1582	1162	1142	1122	1102	1082	1062	1042	1022	1002	982
Medium	1247	827	807	787	767	747	727	712	712	712	712
Low	976	694	694	694	694	694	694	694	694	694	694
Heating	Default	-31	-32	-33	-34	-35	-36	-37	-38	-39	-40~-41
Turbo	1659	1039	1019	999	979	959	939	919	899	879	859
High	1582	962	942	922	902	882	862	842	822	802	782
Medium	1247	712	712	712	712	712	712	712	712	712	712
Low	976	694	694	694	694	694	694	694	694	694	694
Heating	Default	+1	+2	+3	+4	+5	+6	+7	+8	+9	+10
Turbo	1659	1679	1699	1719	1739	1759	1779	1799	1819	1839	1859
High	1582	1602	1622	1642	1662	1682	1702	1722	1742	1762	1782
Medium	1247	1267	1287	1307	1327	1347	1367	1387	1407	1427	1447
Low	976	996	1016	1036	1056	1076	1096	1116	1136	1156	1176
Heating	Default	+11	+12	+13	+14	+15	+16	+17	+18	+19	+20
Turbo	1659	1879	1899	1919	1939	1959	1979	1999	2019	2039	2059
High	1582	1802	1822	1842	1862	1882	1902	1922	1942	1962	1982
Medium	1247	1467	1487	1507	1527	1547	1567	1587	1607	1627	1647
Low	976	1196	1216	1236	1256	1276	1296	1316	1336	1356	1376

7. Noise Criterion Curves

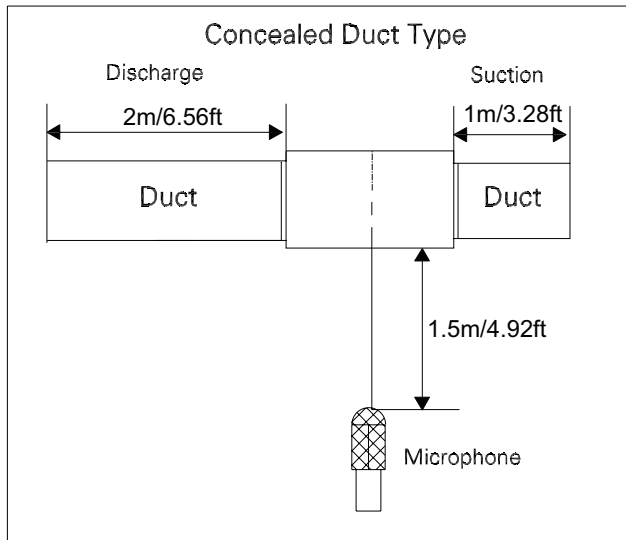

Horizontal installation

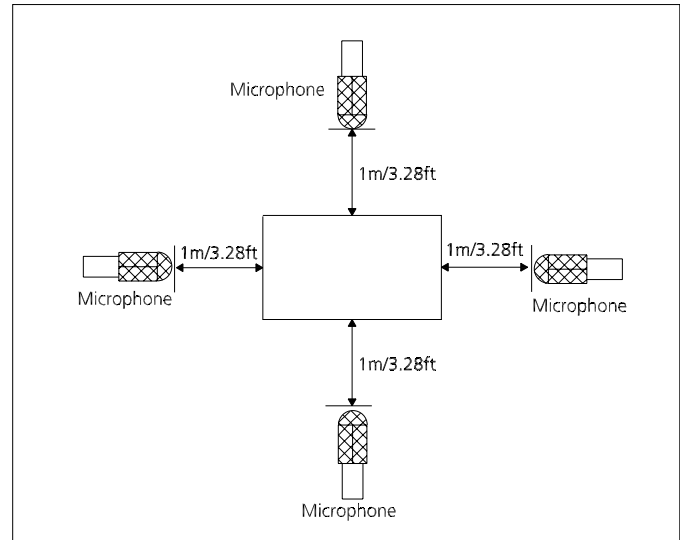

Vertical installation

$$(H = 0.5 \times (\text{height of unit} + 1))$$

Notes:

- Sound measured at 1.5m/4.92ft(Horizontal installation) /1m/3.28ft(Vertical installation) away from the center of the unit.
- Data is valid at free field condition
- Data is valid at nominal operation condition
- Reference acoustic pressure $OdB = 20\mu Pa$
- Sound level will vary depending on a range of factors such as the construction -(acoustic absorption coefficient) of particular room in which the equipment is installed.
- The operating conditions are assumed to be standard.

MVBC-18HWFN10-MB1

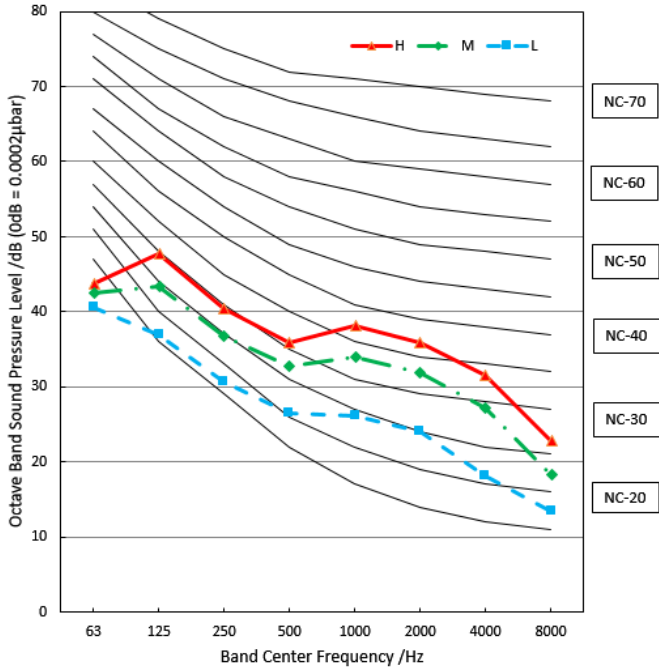

MVBC-24HWFN10-MB1

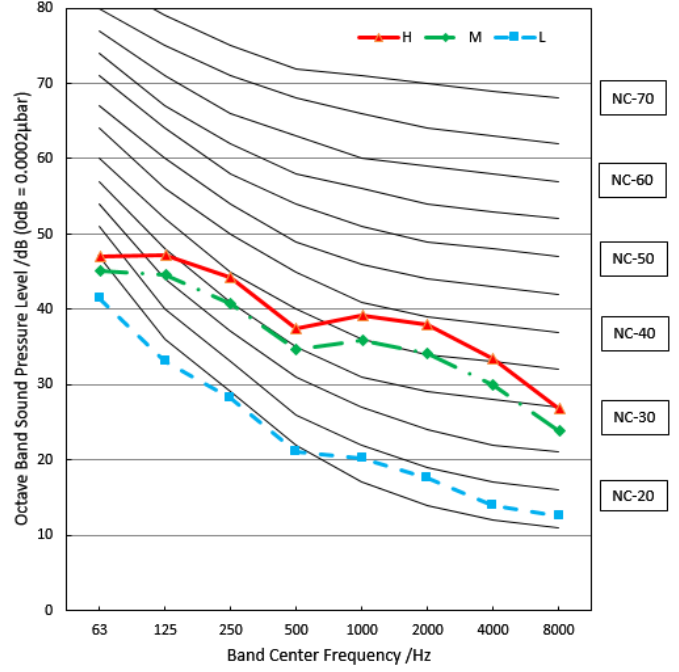

MVBC-30HWFN10-MC1

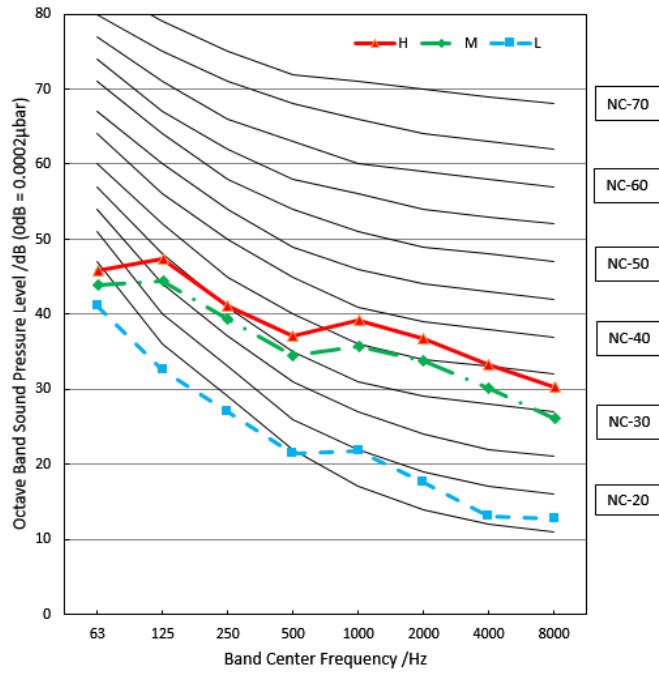

MVBC-36HWFN10-MC1

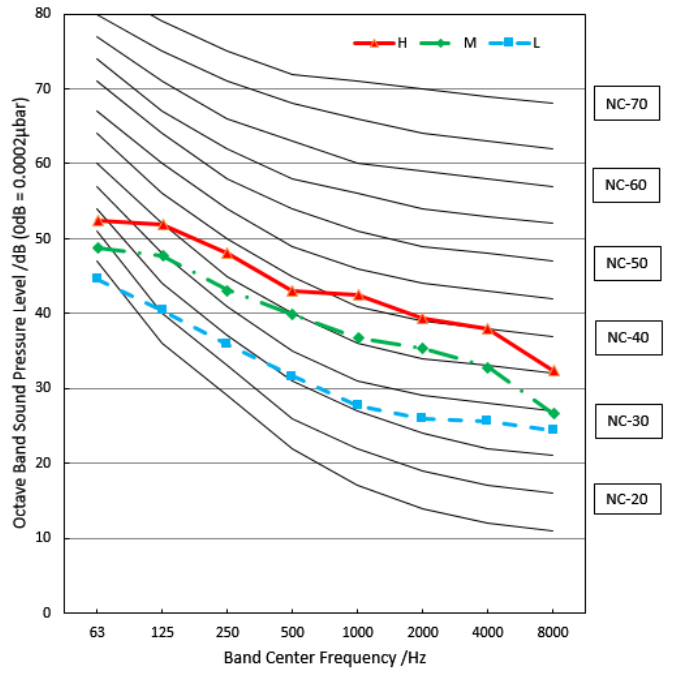

MVBC-36HWFN10-MC2

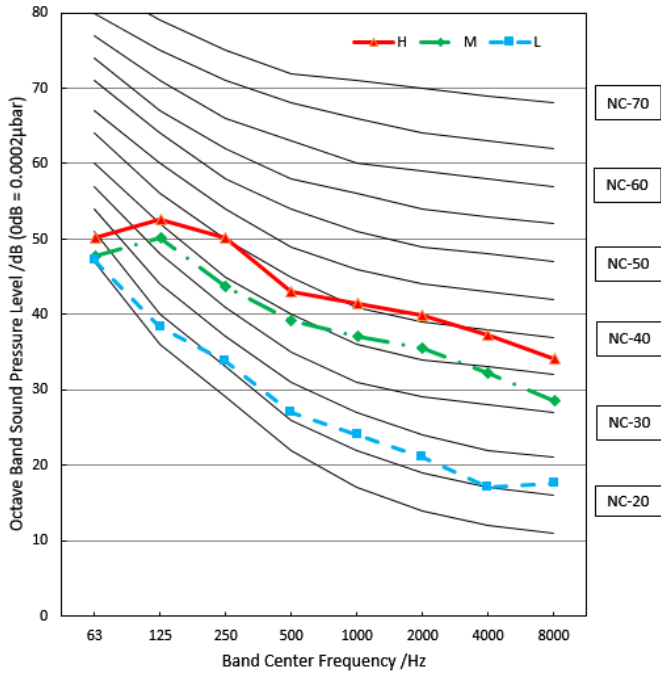

MVBC-48HWFN10-MD2

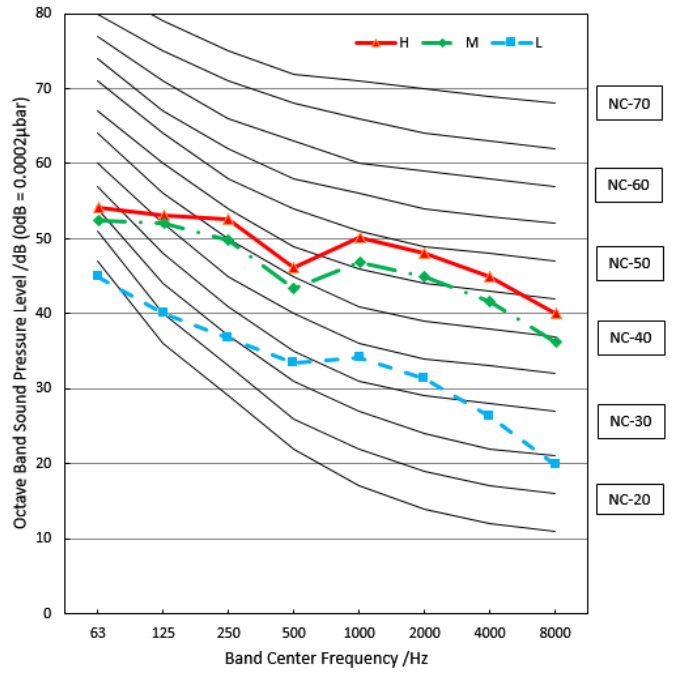

MVBC-60HWFN10-MD2

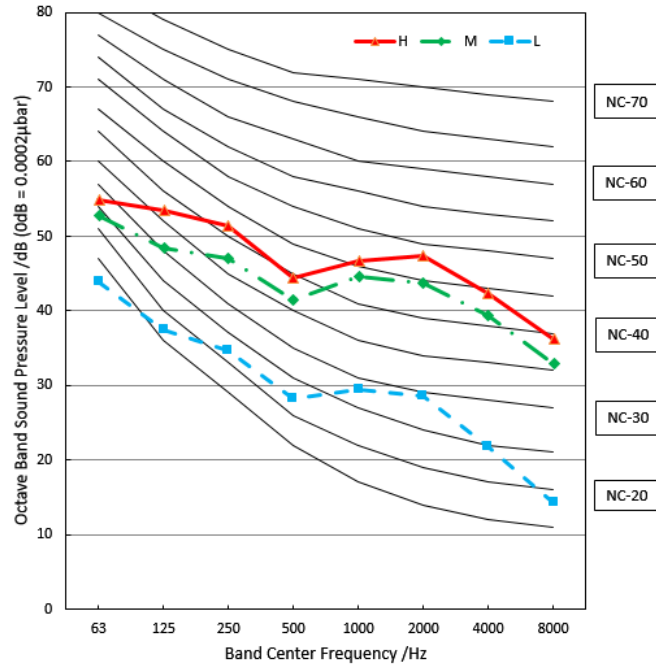

8. Refrigerant System Diagram

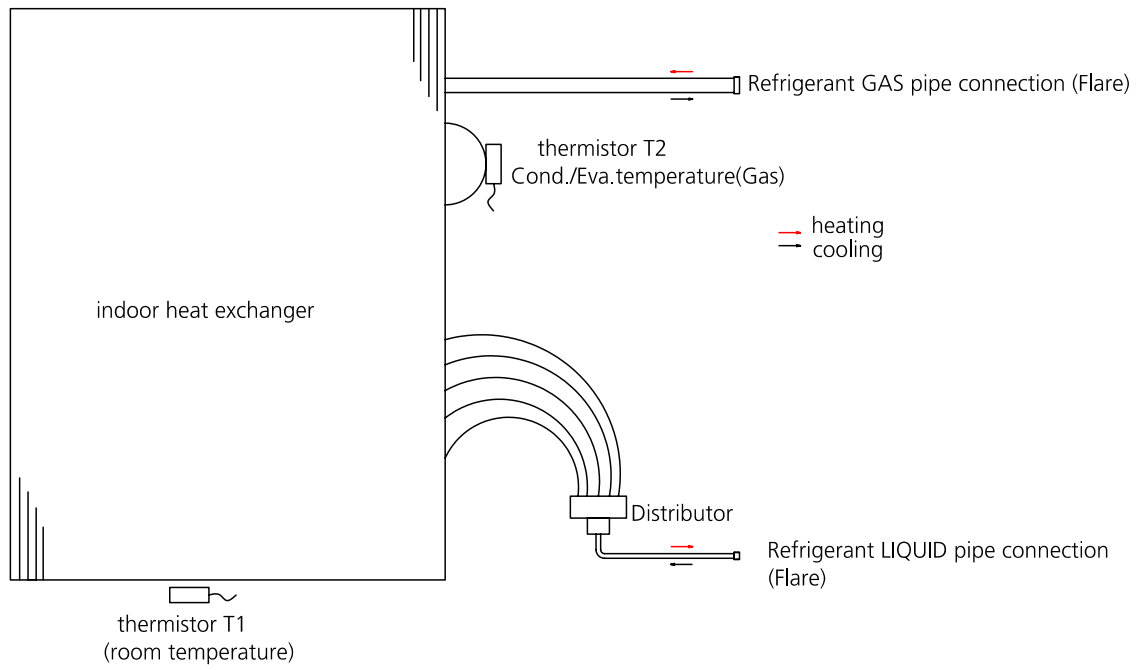

9. Electrical Characteristics

IDU Model		18k	24k	30k/36k	48k	60k
Power	Phase	1				
	Frequency And Volt	208/230V,60Hz				
Minimum Circuit Ampacity	A	3	4	6	9.75	11
Max Fuse	A	15	15	15	15	15

10. Electrical Wiring Diagrams

IDU Model	IDU Wiring Diagram
MVBC-18HWFN10-MB1	16023000014232
MVBC-24HWFN10-MB1	
MVBC-30HWFN10-MC1	16023000015672
MVBC-36HWFN10-MC1	
MVBC-36HWFN10-MC2	16023000015673
MVBC-48HWFN10-MD2	
MVBC-60HWFN10-MD2	

Abbreviation	Paraphrase
Y/G	Yellow-Green Conductor
FAN1	Indoor ECM Motor
TO CCM Comm.Bus	Central Controller
T1	Indoor Room Temperature Sensor
T2	Indoor Coil Temperature Sensor

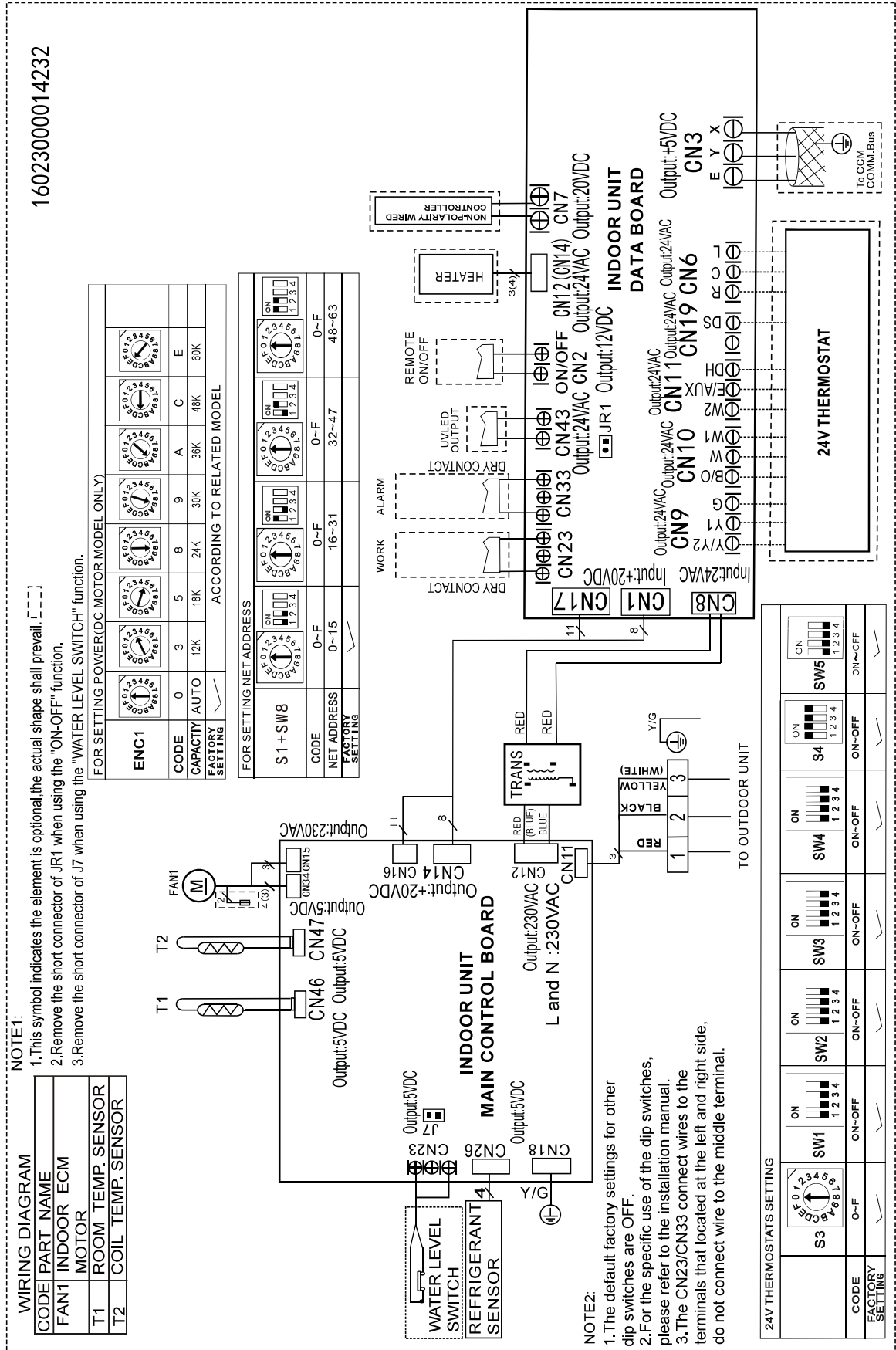

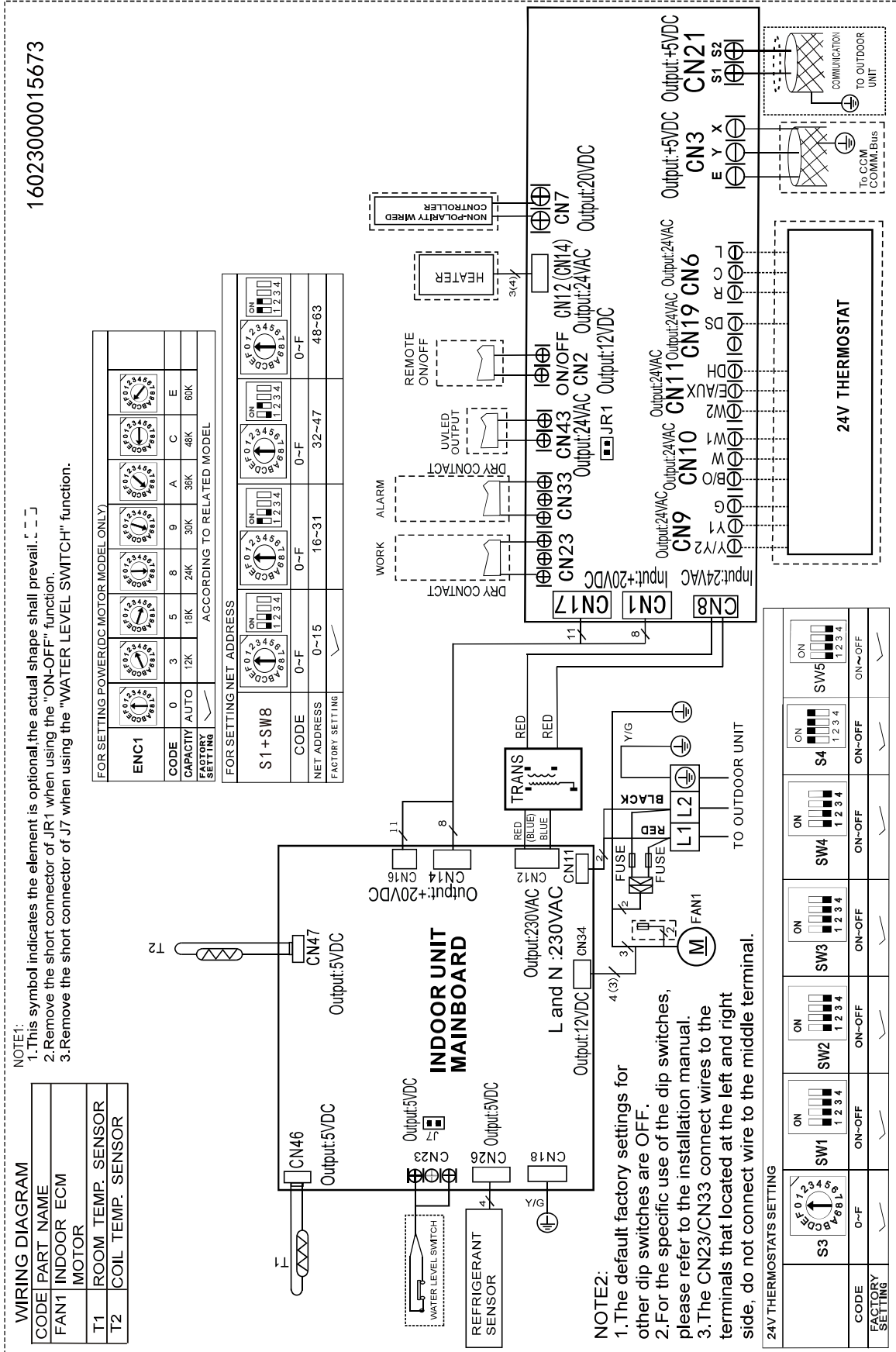

10.1 Micro-Switch Introduce:

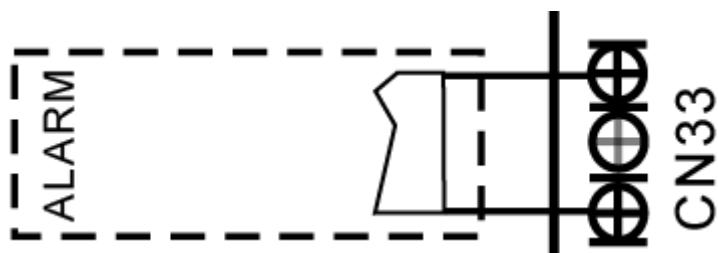

A For ALARM terminal port CN33

1. Provide the terminal port to connect ALARM, but no voltage of the terminal port , the power from the ALARM system (not from the unit)
2. Although design voltage can support higher voltage ,but we strongly ask you connect the power less than 24V, current less than 0.5A
3. When the unit occurs the problem , the relay would be closed , then ALARM works

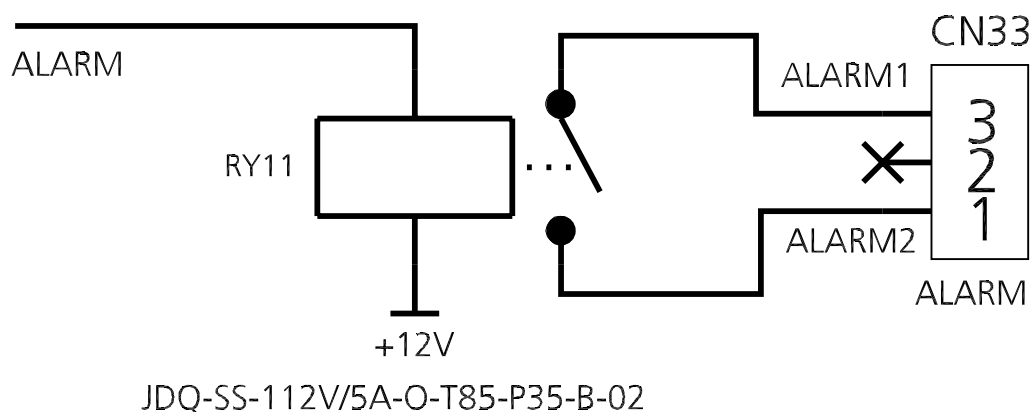

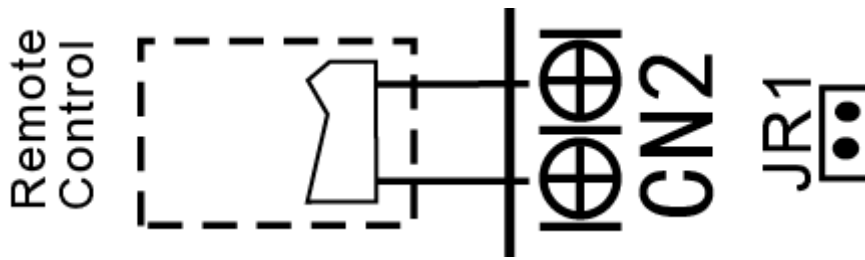

B. For remote control (ON-OFF) terminal port CN2 and short connector of JR1

1. Remove the short connector of JR1 when you use ON-OFF function;
2. When remote switch off (OPEN); the unit would be off;
3. When remote switch on (CLOSE); the unit would be on;
4. When close/open the remote switch, the unit would be responded the demand within 2 seconds;
5. When the remote switch on, you can use remote controller/ wire controller to select the mode what you want; when the remote switch off, the unit would not respond the demand from remote controller/wire controller. when the remote switch off, but the remote controller/wire controller are on, CP code would be shown on the display board.
6. The voltage of the port is 12V DC, design Max. current is 5mA.

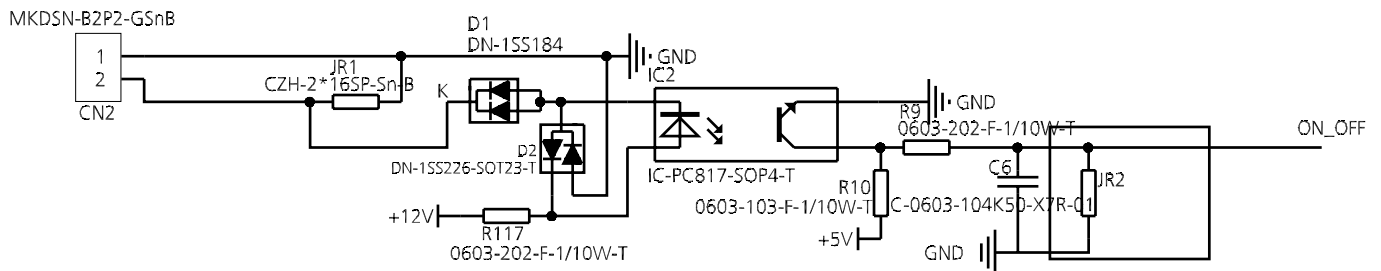

C. Function DIP Switch Settings

The 24V thermostat mode needs to refer to the following settings

No.	Dial code	Function	ON	OFF(Default)	Note
Control Scenario		24V Tstat, S1+S2			
1	SW1-2	Anti-cold blow protection option	No	[Default] Yes	
2	SW1-3	Single cooling / heating and cooling options	Cooling	[Default] Cooling & Heating	
3	SW2-1	Compressor Running (demand working with heat pump+ Electric heat)	Compressor slower speed	[Default] Faster Compressor	Only affects compressor and W1
4	SW2-4	Compressor	The operation of heat pump is limited by the outdoor temperature, and the operation of auxiliary heat is not limited. The system makes judgments according to the following rules:1) The compressor can be operated when the outdoor temperature is \geq S3 DIP switch temperature +2 °C. 2) The compressor cannot be operated when the outdoor temperature is lower than the S3 DIP switch temperature.	[Default] The operation of heat pump is limited by the outdoor temperature, and the operation of auxiliary heat is not limited. The system makes judgments based on the following rules:1) The compressor cannot be operated when the outdoor temperature is lower than the S3 DIP switch. 2) The compressor can be operated when the outdoor temperature is \geq S3 DIP switch temperature +2 °C.	SW2-4 and S3 need to working together
5	Rotary Switch S3	Set outdoor temperature Limitation (for auxiliary heating or compressor)	Table A		
6	SW3-1	Maximum continuous runtime allowed before system automatically stages up capacity to satisfy set point. This adds 1 to 5°F to the user set point in the calculated control point to increase capacity and satisfy user set point	30 minutes	[Default] 90 minutes	
7	SW3-2	Cooling and heating Y/ Y2 temperature differential adjustment.	Compressor slower speed	[Default] Faster Compressor	Only affects compressor
8	SW3-3	Compressor Running (demand working with heat pump+ Electric heat)	Compressor slower speed	[Default] Faster Compressor	Only affects compressor and W2
9	SW3-4	Fan speed of cooling mode when 24V Thermostat is applied for.	Turbo	High	
10	SW4-1 SW4-2 SW4-3	Electric heat nominal CFM adjustment	Available settings are 000/001/010/011. Each digit corresponds an individual switch position. For example [SW4-1 OFF, SW4-2 ON, SW4 -3 OFF] = 010		
11	S4-4	Default ON	[Default] For single stage supplemental heat, W1 and W2 are connected	For dual stage supplemental heat, W1 and W2 are controlled independently.	
12	S4-2	DH function selection	[Default] Dehumidification control not available	Dehumidification feature is enabled through thermostat	
13	SW5-3	L or Alarm relay selection	L output 24V or alarm relay close only when refrigerant sensor fault or R454B refrigerant leakage be detected	[Default] L output 24V or alarm relay close when any fault be detected	

14	SW5-4	R output selection	R stop output 24V when refrigerant sensor fault or R454B refrigerant leakage be detected	[Default] R keep output 24V even when refrigerant sensor fault or R454B refrigerant leakage be detected	
Control Scenario		Wired Controller S1+S2			
1	SW1-2	Anti-cold blow protection option	No	[Default] Yes	
2	SW1-3	Single cooling / heating and cooling options	Cooling	[Default] Cooling & Heating	
3	SW2-1	Temperature differential to activate first stage auxiliary heat(the GAP of T1 and Ts),Wire controller demand with heat pump+Electric heat working together	2°F(1°C)	[Default] 4°F(2°C)	
4	SW2-2	Electric heat on delay	Yes	[Default] No	
5	SW2-3	Electric auxiliary heating delay to start time	30 minutes	[Default] 15 minutes	Based on SW2-2 is ON
6	SW2-4	Compressor/Auxiliary heat outdoor ambient lockout	The operation of heat pump is limited by the outdoor temperature, and the operation of auxiliary heat is not limited. The system makes judgments according to the following rules:1) The compressor can be operated when the outdoor temperature is \geq S3 DIP switch temperature +2 °C. 2) The compressor cannot be operated when the outdoor temperature is lower than the S3 DIP switch temperature.	[Default] Only one heat pump or auxiliary heat can be operated .The system makes judgments according to the following rules:1) When the outdoor temperature is lower than the S3 DIP switch temperature,the compressor is not allowed to operated, but auxiliary heat is allowed to operated; 2) When the outdoor temperature is \geq S3 DIP switch temperature +2(°C), the compressor can be operated, but auxiliary heat cannot be operated.	SW2-4 and S3 need to working together
7	Rotary Switch S3	Set outdoor temperature Limitation (for auxiliary heating or compressor)	Table A		
8	SW3-3	Temperature differential to activate second stage auxiliary heating(the GAP of T1 and Ts) Wire controller demand with heat pump+Electric heat working together	4°F(2°C)	[Default] 6°F(3°C)	
9	SW4-1 SW4-2 SW4-3	Electric heat nominal CFM adjustment	Available settings are 000/001/010/011. Each digit corresponds an individual switch position. For example [SW4-1 OFF, SW4-2 ON, SW4 -3 OFF] = 010		
10	SW4-4	Temperature diferential to activate third stage auxiliary heating(the GAP of T1 and Ts) Wire controller demand with heat pump+ Electric heat working together	6°F(3°C)	[Default] 8°F(4°C)	Only valid for product which has three stage auxiliary heating.
11	SW5-3	L or Alarm relay selection	L output 24V or alarm relay close only when refrigerant sensor fault or R454B refrigerant leakage be detected	[Default] L output 24V or alarm relay close when any fault be detected	
12	SW5-4	R output selection	R stop output 24V when refrigerant sensor fault or R454B refrigerant leakage be detected	[Default] R keep output 24V even when refrigerant sensor fault or R454B refrigerant leakage be detected	

Control Scenario		Full 24V(Note: Control scenario 3 is not applicable for this unit.)			
1	SW1-2	Anti-cold blow protection option	No	[Default] Yes	
2	SW1-3	Single cooling / heating and cooling options	Cooling	[Default] Cooling & Heating	
3	SW3-4	Fan speed of cooling mode when 24V Thermostat is applied for.	Turbo	High	
4	SW4-1 SW4-2 SW4-3	Electric heat nominal CFM adjustment	Available settings are 000/001/010/011. Each digit corresponds an individual switch position. For example [SW4-1 OFF, SW4-2 ON, SW4 -3 OFF] = 010		
5	S4-4	Default ON	[Default] For single stage supplemental heat,W1 and W2 are connected	For dual stage supplemental heat, W1 and W2 are controlled independently.	
6	S4-2	DH function selection	[Default] Dehumidification control not available	Dehumidification feature is enabled through thermostat	
7	SW5-3	L or Alarm relay selection	L output 24V or alarm relay close only when refrigerant sensor fault or R454B refrigerant leakage be detected	[Default] L output 24V or alarm relay close when any fault be detected	
8	SW5-4	R output selection	R stop output 24V when refrigerant sensor fault or R454B refrigerant leakage be detected	[Default] R keep output 24V even when refrigerant sensor fault or R454B refrigerant leakage be detected	



Table A

S3	S3 (°F)	S3(°C)	S3	S3 (°F)	S3(°C)
0	OFF	OFF	8	10	-12
1	-22	-30	9	18	-8
2	-18	-28	A	25	-4
3	-15	-26	B	32	0
4	-11	-24	C	36	2
5	-8	-22	D	39	4
6	-4	-20	E	43	6
7	3	-16	F	46	8

SW4-1	000 is the default
SW4-2	000/001/010/011/100/101/110/111, internal machines with different abilities, electric heating and PSC classification for use
SW4-3	

Function combination table of SW1-1 and SW1-4

SW1	Control type	IDU and ODU Connection	Note
	Wired controller / 24V thermostat	(S1+S2) / 24V connection	Auto Discovery

 <p>ON 1 2 3 4</p>	Wired controller	S1+S2	Scenario 2
 <p>ON 1 2 3 4</p>	24V Thermostat	S1+S2	Scenario 1
 <p>ON 1 2 3 4</p>	24V Thermostat	24V Thermostat	Scenario 3

Installation

Contents

1. Location Selection
2. Indoor Unit Installation
3. Connecting the Wire And Pipes
4. Refrigerant Pipe Installation
5. Engineering of Insulation
6. Installation of Electric Auxiliary Heat Module(Only For Heat Function Models)
7. Engineering of Electrical Wiring

1. Location selection

1.1 Unit location selection can refer to installation manual.

1.2 DO NOT install the unit in the following locations:

- DO NOT install the indoor unit in a moist environment. Excessive moisture can corrode the equipment, electrical components, and cause electrical shorts.
- Areas with strong electromagnetic waves.
- Coastal areas with high salt content in the air.
- Areas with oil drilling or fracking.
- Areas that store flammable materials or gas.
- Areas where there may be detergent or other corrosive gases in the air, such as bathrooms, or laundry rooms.
- Areas where the air inlet and outlet may be obstructed.
- Danger of explosion. Keep flammable materials and vapors, such as gasoline, away from air handler.

1.3 WARNING: MUST BE INSTALLED IN A LOCATION THAT MEETS THE FOLLOWING REQUIREMENTS:



- ☑ Securely install the indoor unit on a structure that can support its weight. If the structure is too weak, the unit may fall and cause personal injury, unit and property damage, or death.



- ☑ Enough room for installation and maintenance.
- ☑ Enough room for the connecting pipe and drainpipe.

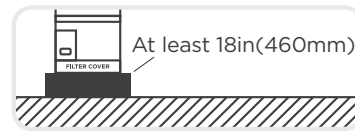

- ☑ Place air handler so that heating elements are at least 18in(460mm) above the floor for a garage installation. Failure to follow these instructions can result in death, explosion, or fire.

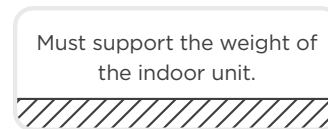

- ☑ The structure that the equipment is suspended from must support the weight of the indoor unit.

2. Indoor Unit Installation

2.1 Service space for indoor unit

Horizontal installation

Plenum Clearances:

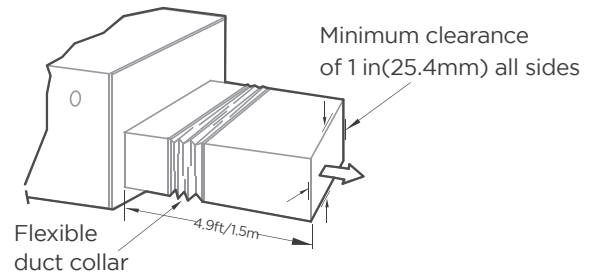

The outlet side pipe length 4.9ft/1.5m.

Vertical installation

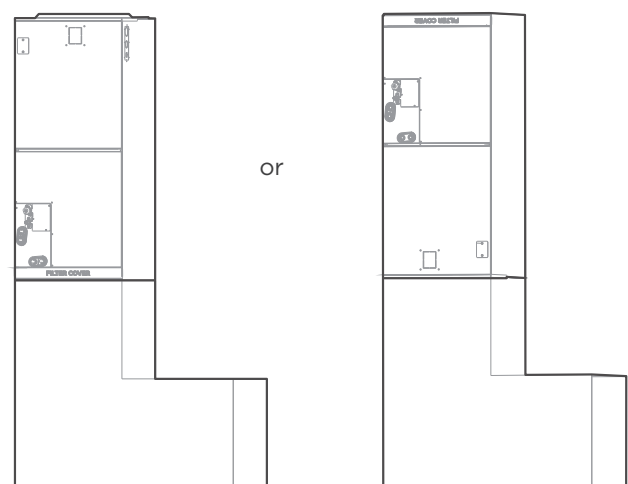

When installed vertically (upward or downward), the lower end of the air outlet needs to be connected to the L-shaped metal air duct and fastened by screws.

2.2 Installation place

Vertical installation

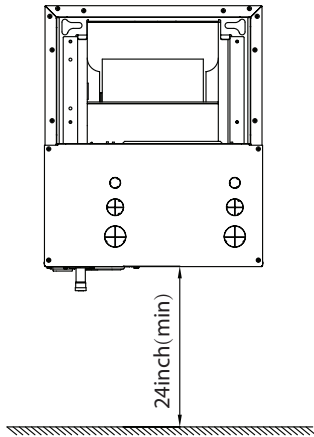

Horizontal installation

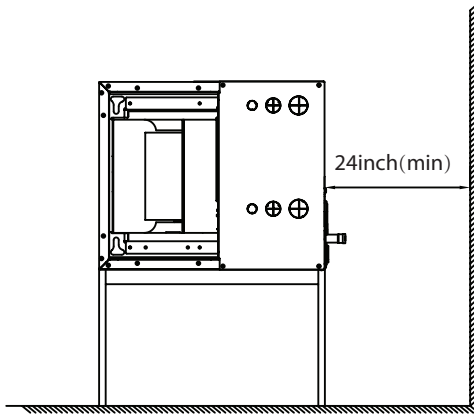

2.2 Install the main body

The units can be installed in a vertical (down and up) and Horizontal (right and left) configuration.

Vertical installation

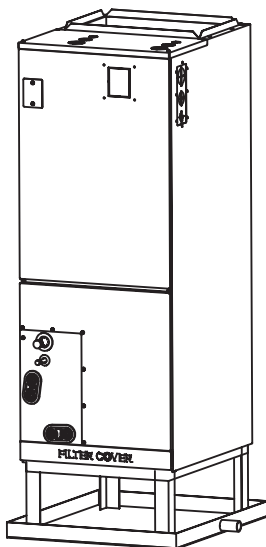

Horizontal installation

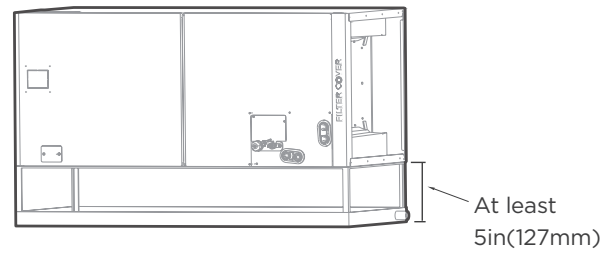

Horizontal

NOTICE: For horizontal installation, a secondary drain pan (not supplied) must be installed.

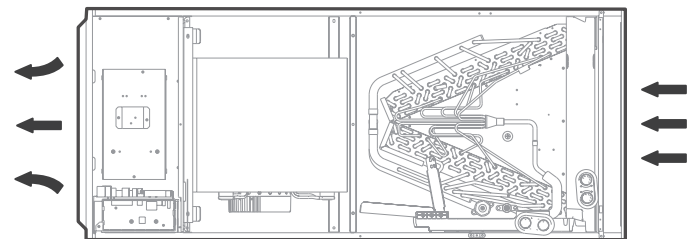
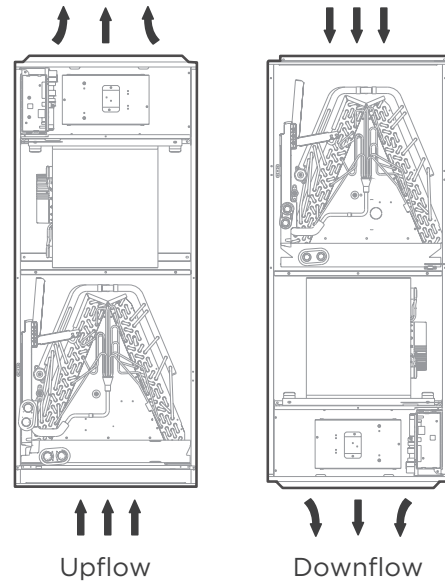

Horizontal left

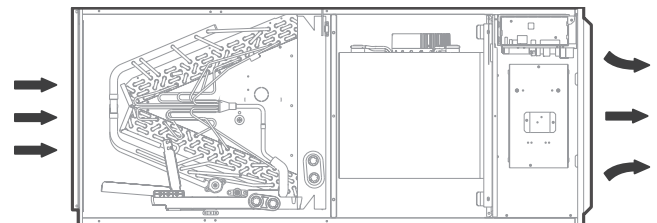

Horizontal right

Note: Vertical up and horizontal left installation does not need to change the direction of evaporator.

3. Connecting the wire and pipes (pipes and drainage pipes)

3.1 Please follow these steps to perform Vertical down installation and Horizontal right installation:

1. Open the upper cover.
2. Open the cover of the electronic control box.
3. Connect the wire according to the wiring diagram.
4. Connect the pipes and install the drainage pipes

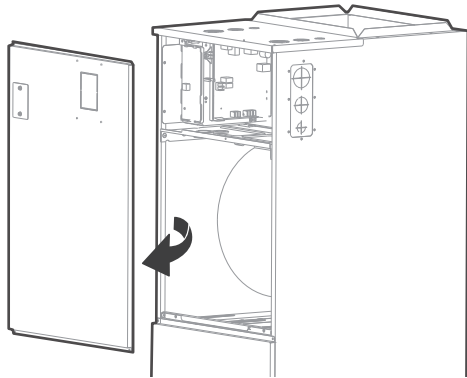

3. Remove evaporator cover plate.

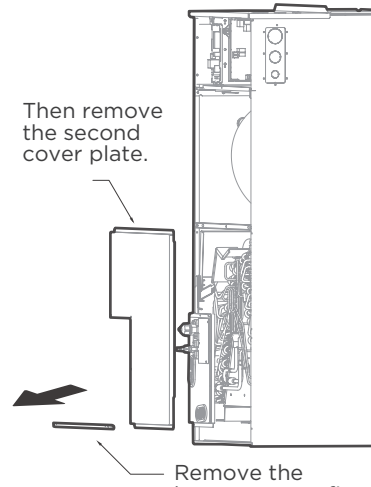

4. Indication of the position of each temperature sensor of the evaporator, confirm your model.

18-24K model

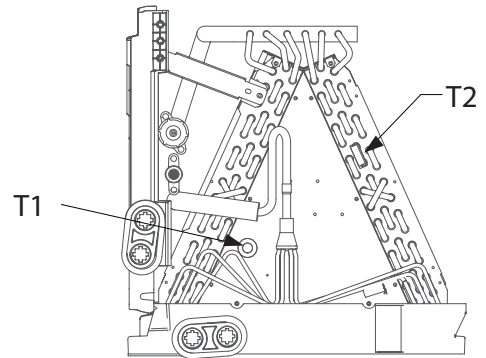

30-36K model

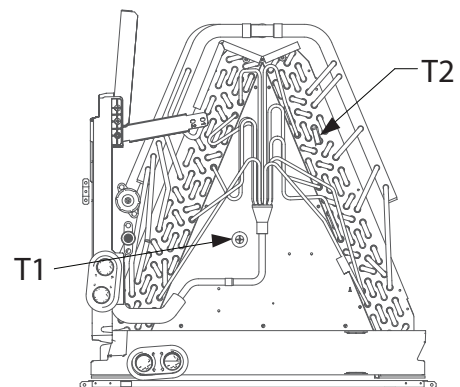

3.2 Down flow and horizontal right instructions

NOTICE: The unit may be installed in one of the upflow, downflow, horizontal left or horizontal right orientations

1. Remove the filter door, then take the filter off.

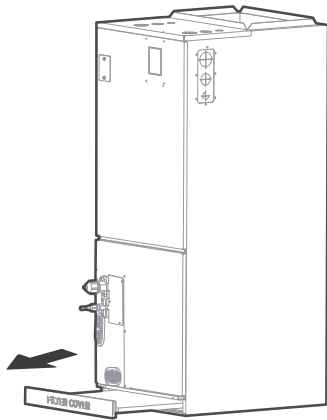

2. Remove the upper cover assembly.

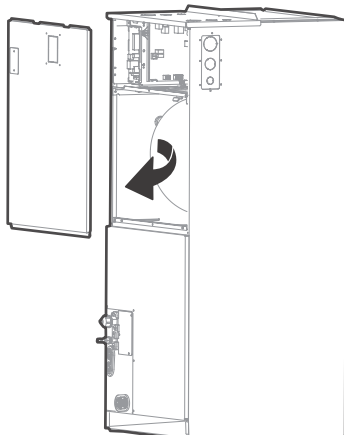

48-60K model

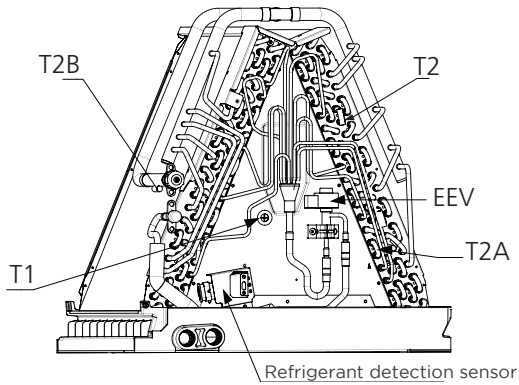

5. Unplug temperature sensors T1,T2,refrigerant detection sensor from the control board.

T1: Room temperature sensor

T2: Evaporator central sensor plug

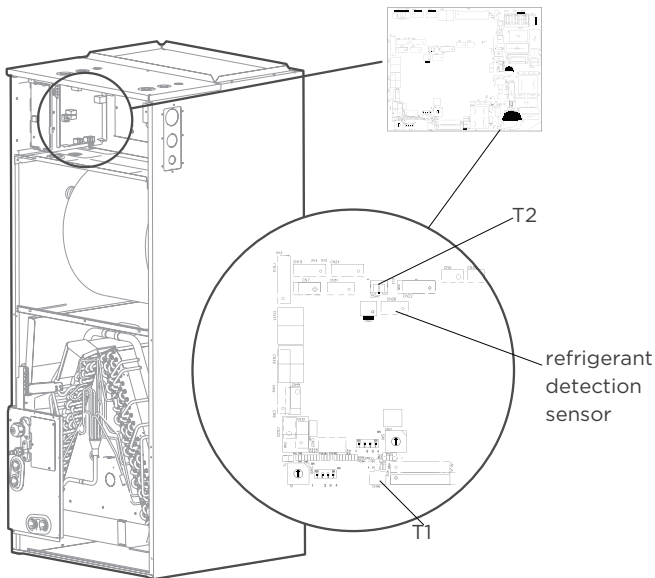

6. Remove T1, T2, refrigerant detection sensor wire ties.

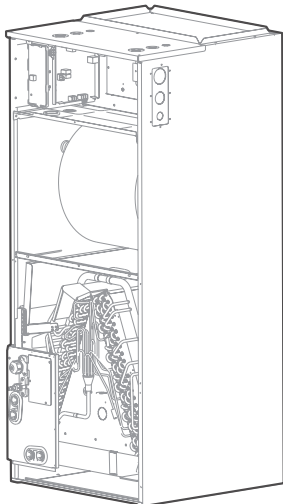

7. Take out the evaporator and drain pan and rotate 180° (when your equipment need to be vertical downed configuration)..

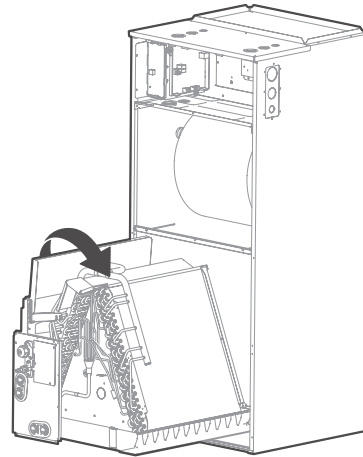

8.Adjust the mounting parts position according to the direction of equipment.

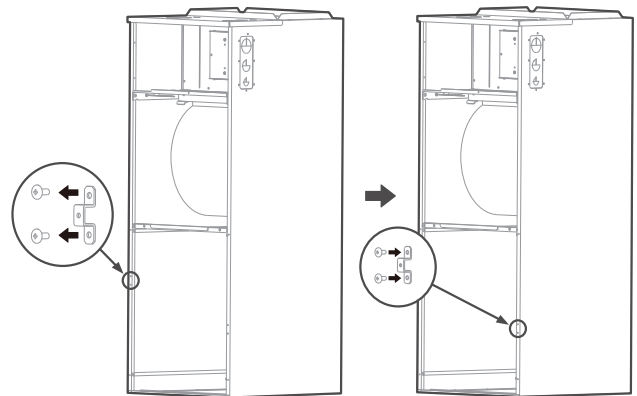

9. Reinstall the evaporator and drain pan.

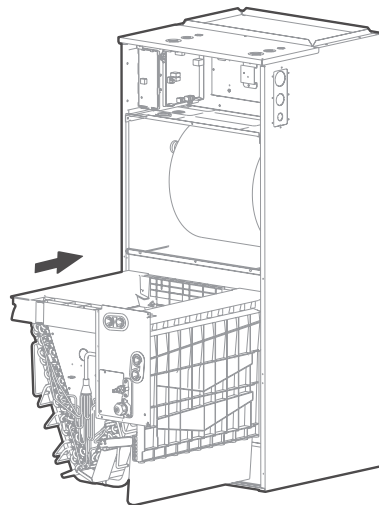

10. Reinstall T1,T2 sensor plug and tie up the sensor wires.

Note: The wire body needs to pass through the wire groove from the drain pan and be stuck on the hook of the drain pan

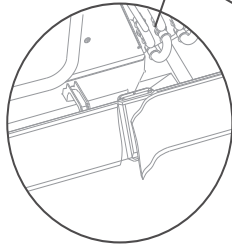
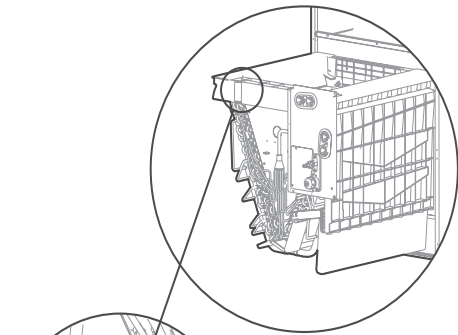

Cut the foam gasket.

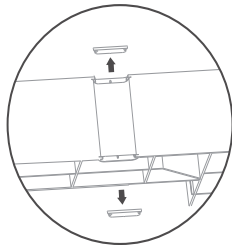

Remove knockouts as shown in the figure.

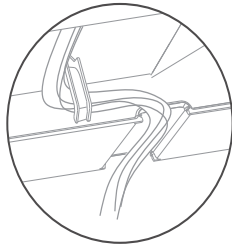

Hook the wire into the buckle and go down from the wire slot.

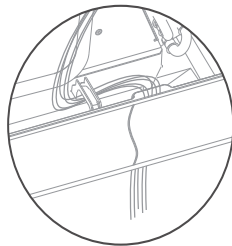

Replace foam gasket over wires.

11. The evaporator is assembled in place.

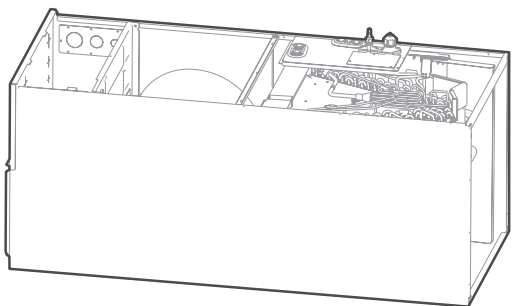

12. Use cable ties to fix the room temperature sensor as shown in the figure.

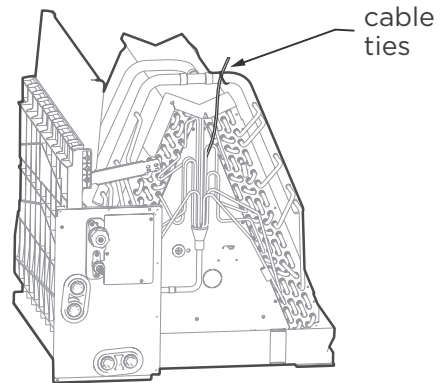

13. Reinstall evaporator cover plate.

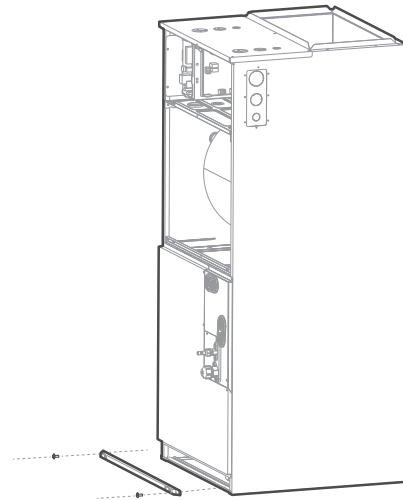

14. Connect the wire according to the wiring diagram.

15. Reassemble the upper cover and Reinstall the filter, filter cover plate.

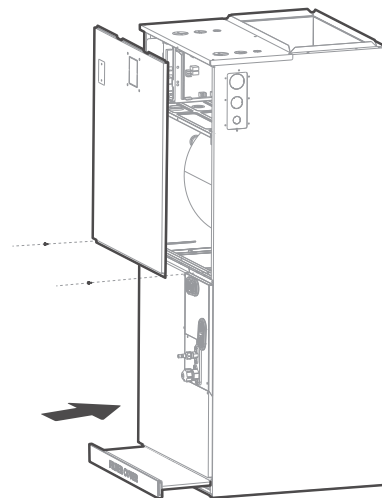

15. Connect the pipes and install the drainage pipes.

⚠ CAUTION FOR ALL PIPES INSTALLATION

- Insulate all piping to prevent condensation, which could lead to water damage.
- The drainpipe is used to drain water away from the unit. If the drainpipe is bent or installed incorrectly, water may leak and cause a water-level switch malfunction.
- In HEAT mode, the outdoor unit will discharge water. Ensure that the drain hose is placed in an appropriate area to avoid water damage and icy conditions on walkways.
- DO NOT pull the drainpipe forcefully. This could disconnect it.

NOTICE: If installed above a finished living space, a secondary drain pan (as required by many building codes), must be installed under the entire unit and its condensate drain line must be routed to a location such that the user will see the condensate discharge.

NOTICE ON PURCHASING PIPES:

Installation requires pvc pipe or other suitable material per local and national codes, which can be obtained at your local hardware store or dealer.

WARNING:

- After removal of drain pan plug(s), check drain hole(s) to verify that drain opening is fully open and free of any debris. Also check to make sure that no debris has fallen into the drain pan during installation that may plug up the drain opening. Seal around the exiting drain pipe, liquid and suction lines to prevent infiltration of humid air.
- On units of this type, where the blower “draws” rather than “blows” air through the coil, traps must be installed in the condensate drain lines (primary and auxiliary, if used). Traps prevent the blower from drawing air through the drain lines into the air supply.

3.3 Vertical Installations

- These units operate with a negative pressure at the drain connections and a drain trap is required. The trap needs to be installed as close to the unit as possible. Make sure the top of the trap is below the connection to the drain pan to allow complete drainage of the pan.

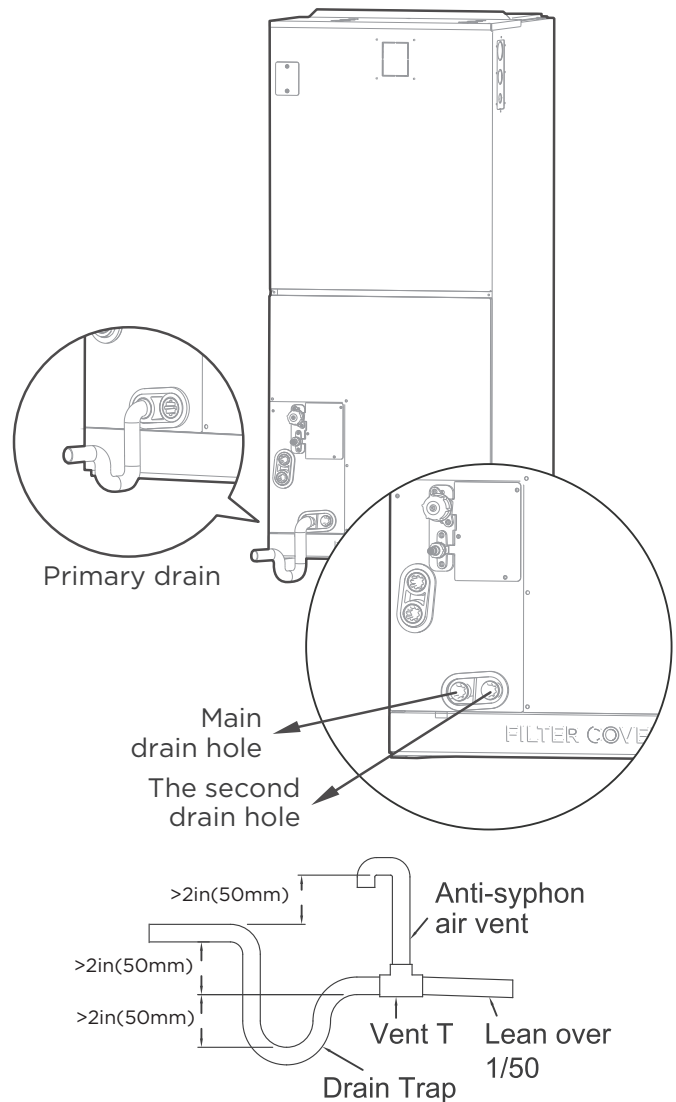

NOTICE:

Horizontal runs must also have an anti-siphon air vent(standpipe) install ahead of the horizontal run to eliminate air trapping.

NOTE ON DRAINPIPE INSTALLATION:

- The Figure shows how to trap or plug all drains during vertical discharge.
- The Figure shows how to trap or plug all drains during right-hand discharge.
- The seal plug are supplied as accessories and should be screwed tightly only by hand.
- Incorrect installation could cause water to flow back into the unit and flood.

⚠ CAUTION:

The drainpipe outlet should be at least 5cm(1.9in) above the ground. If it touches the ground, the unit may become blocked and malfunction.

4. Refrigerant Pipe Installation

4.1 Recommended copper pipe thickness

Pipe diameter (inch(mm))	Thickness(inch/mm)
Ø1/4 (Ø6.35)	0.024/0.6
Ø3/8 (Ø9.52)	0.028/0.7
Ø1/2 (Ø12.7)	0.03/0.75
Ø5/8 (Ø15.9)	0.03/0.75
Ø3/4 (Ø19)	0.031/0.8

4.2 Maximum length and drop height

Ensure that the length of the refrigerant pipe, the number of bends, and the drop height between the indoor and outdoor units meets the requirements shown in the following table.

Current Loop

Capacity (kBtu/h)	Max. Length (ft/m)	Max. Elevation (ft/m)
18	98.4/30	65.6/20
24~30	164/50	82/25
36	213.3/65	98.4/30

RS485

Capacity (kBtu/h)	Max. Length (ft/m)	Max. Elevation (ft/m)
36~60	246/75	98.4/30

Caution:

1. The capacity test is based on the standard length and the maximum permissible length is based on the system reliability.

2. Oil traps

-If oil flows back into the outdoor unit's compressor, this might cause liquid compression or deterioration of oil return. Oil traps in the rising gas piping can prevent this.

-An oil trap should be installed every 6m(20ft) of vertical suction line riser (<36000Btu/h unit).

-An oil trap should be installed every 10m(32.8ft) of vertical suction line riser (≥36000Btu/h unit).

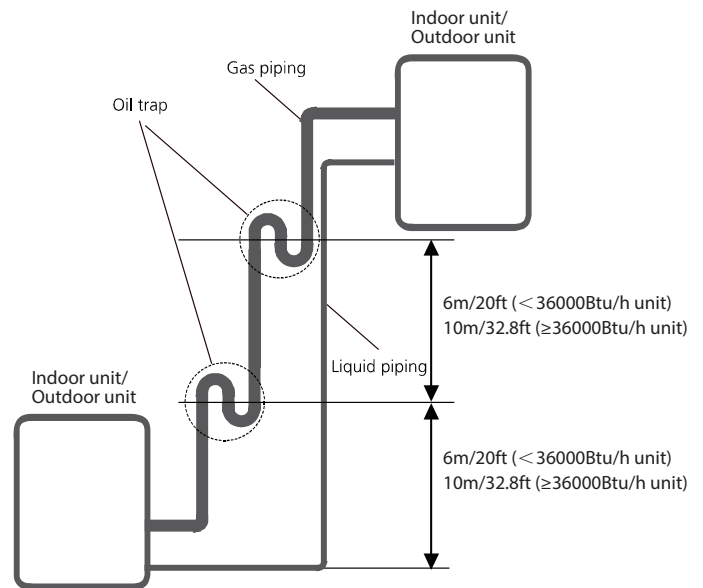

4.3 The procedure of connecting pipes

1. Choose the pipe size according to the specification table.
2. Confirm the cross way of the pipes.
3. Measure the necessary pipe length.
4. Cut the selected pipe with pipe cutter
 - Make the section flat and smooth.

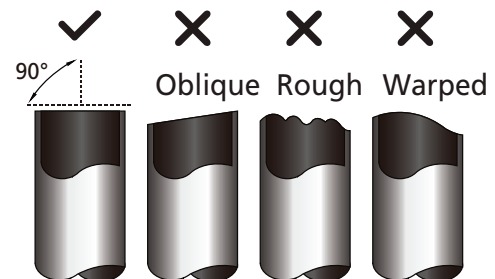

5. Insulate the copper pipe

- Before test operation, the joint parts should not be heat insulated.

6. Flare the pipe

- Insert a flare nut into the pipe before flaring the pipe
- According to the following table to flare the pipe.

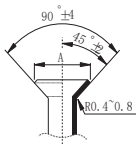
Pipe diameter (inch(mm))	Flare dimension A (inch/mm)		Flare shape
	Min	Max	
Ø1/4 (Ø6.35)	0.33/8.4	0.34/8.7	
Ø3/8 (Ø9.52)	0.52/13.2	0.53/13.5	
Ø1/2 (Ø12.7)	0.64/16.2	0.65/16.5	
Ø5/8 (Ø15.9)	0.76/19.2	0.78/19.7	
Ø3/4 (Ø19)	0.91/23.2	0.93/23.7	

NOTE: MINIMUM BEND RADIUS

Carefully bend the tubing in the middle according to the diagram below.

DO NOT bend the tubing more than 90° or more than 3 times.

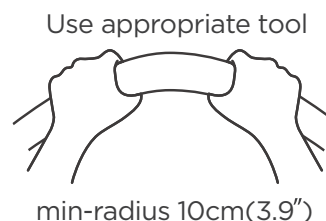

- After flared the pipe, the opening part must be seal by end cover or adhesive tape to avoid duct or exogenous impurity come into the pipe.

7. Drill holes if the pipes need to pass the wall.

8. According to the field condition to bend the pipes so that it can pass the wall smoothly.

9. Bind and wrap the wire together with the insulated pipe if necessary.

10. Set the wall conduit.

11. Set the supporter for the pipe.

12. Locate the pipe and fix it by supporter.

- For horizontal refrigerant pipe, the distance between supporters should not be exceed 1m.
- For vertical refrigerant pipe, the distance between supporters should not be exceed 1.5m.

13. Connect the pipe to indoor unit and outdoor unit by using two spanners.

- Be sure to use two spanners and proper torque to fasten the nut, too large torque will damage the bellmouthing, and too small torque may cause leakage. Refer the following table for different pipe connection.

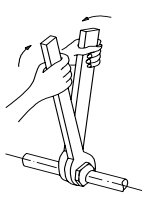
Pipe diameter (inch(mm))	Torque	Sketch map
	N.m(lb.ft)	
Ø1/4 (Ø6.35)	18~20 (13.3~14.8)	
Ø3/8 (Ø9.52)	32~39 (23.6~28.8)	
Ø1/2 (Ø12.7)	49~59 (36.1~43.5)	
Ø5/8 (Ø15.9)	57~71 (42~52.4)	
Ø3/4 (Ø19)	67~101 (49.4~74.5)	

5 . Engineering of Insulation

5.1 Insulation of refrigerant pipe

1. Operational procedure of refrigerant pipe insulation

Cut the suitable pipe → insulation (except joint section) → flare the pipe → piping layout and connection → vacuum drying → insulate the joint parts

2. Purpose of refrigerant pipe insulation

- During operation, temperature of gas pipe and liquid pipe shall be over-heating or over-cooling extremely. Therefore, it is necessary to carry out insulation; otherwise it shall debase the performance of unit and burn compressor.
- Gas pipe temperature is very low during cooling. If insulation is not enough, it shall form dew and cause leakage.
- Temperature of gas pipe is very high (generally 50-100°C/122-212°F) during heating. Insulation work must be carried out to prevent hurt by carelessness touching.

3. Insulation material selection for refrigerant pipe

- The burning performance should over 120°C/248°F
- According to the local law to choose insulation materials
- Recommended insulation casing thickness

Humidity < 80%RH	Humidity ≥ 80%RH
10mm/0.39in	15mm/0.59in

4. Installation highlights of insulation construction

- Gas pipe and liquid pipe shall be insulated separately, if the gas pipe and liquid pipe were insulated together; it will decrease the performance of air conditioner.

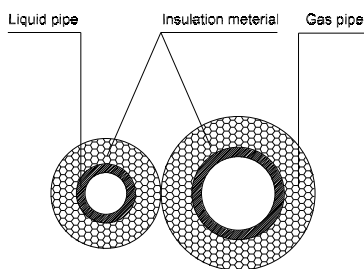

- The insulation material at the joint pipe shall be 5~10cm/1.97~3.97in longer than the gap of the insulation material.
- The insulation material at the joint pipe shall be inserted into the gap of the insulation material.
- The insulation material at the joint pipe shall be banded to the gas pipe and liquid pipe tightly.
- The linking part should be use glue to paste together
- Be sure not bind the insulation material over-tight, it

may extrude out the air in the material to cause bad insulation and cause easy aging of the material.

5.2 Insulation of drainage pipe

1. Operational procedure of refrigerant pipe insulation

Select the suitable pipe → insulation (except joint section) → piping layout and connection → drainage test → insulate the joint parts

2. Purpose of drainage pipe insulation

The temperature of condensate drainage water is very low. If insulation is not enough, it shall form dew and cause leakage to damage the house decoration.

3. Insulation material selection for drainage pipe

- The insulation material should be flame retardant material, the flame retardancy of the material should be selected according to the local law.
- Thickness of insulation layer is usually above 10mm/0.39in.
- Use specific glue to paste the seam of insulation material, and then bind with adhesive tape. The width of tape shall not be less than 5cm/1.97in. Make sure it is firm and avoid dew.

4. Installation and highlights of insulation construction

- The single pipe should be insulated before connecting to another pipe, the joint part should be insulated after the drainage test.
- There should be no insulation gap between the insulation material.

6. Installation Of Electric Auxiliary Heat Module(Only For Heat Function Models)

NOTICE:

Installation must be performed by an licensed contractor. Please make necessary precaution when performing the installation operation.

Preparations for Installation

Before installation, please confirm the electric auxiliary heat module and supplied accessories are complete and free of any damage. Do not attempt to install if damage is present.

Accessories

Name	Quantity
Manual	2
Foam gasket	1
Screws	7
Silicone breaker cover	1
Electric auxiliary heating wiring diagram	1
Circuit breaker label	1

Model size selection

For installations requiring supplemental heating, the optional Electric Auxiliary Heat Module is available in sizes from 3kW to 25kW to accommodate appropriate sizing given the specific heat load and electrical requirements of each installation. Please refer to the table below for selection of available sizes of each outdoor unit model, being sure to avoid improper matching.

Outdoor Unit Model(Btu/h)	3kW	5kW	8kW	10kW	15kW	20kW	25kW
18K	Y	Y	Y	Y	-	-	-
24K	-	Y	Y	Y	Y	-	-
30K	-	Y	Y	Y	Y	-	-
36K	-	Y	Y	Y	Y	Y	-
48K	-	-	Y	Y	Y	Y	-
60K	-	-	-	Y	Y	Y	Y

Electric Auxiliary Heat Module installation and Wiring Operation

1. Open the upper cover.

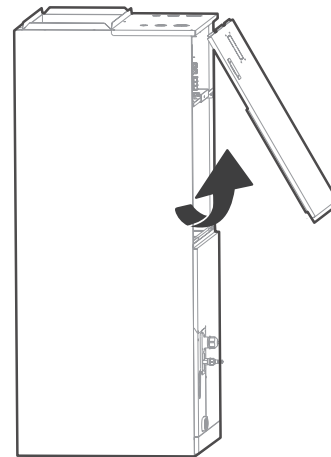

2. Use tools to remove the knock-out holes of upper cover.

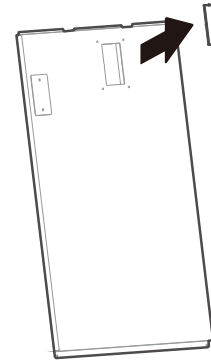

3. Remove the terminal block and power wires, loosen the screws, and remove the electric auxiliary heating cover.

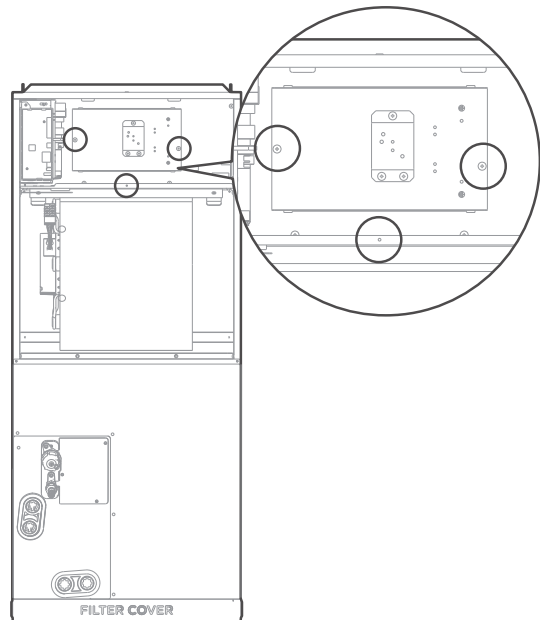

4. Install the electric auxiliary heating assembly the front, and note that the support assembly must lock into the support holes in the back of the cabinet.

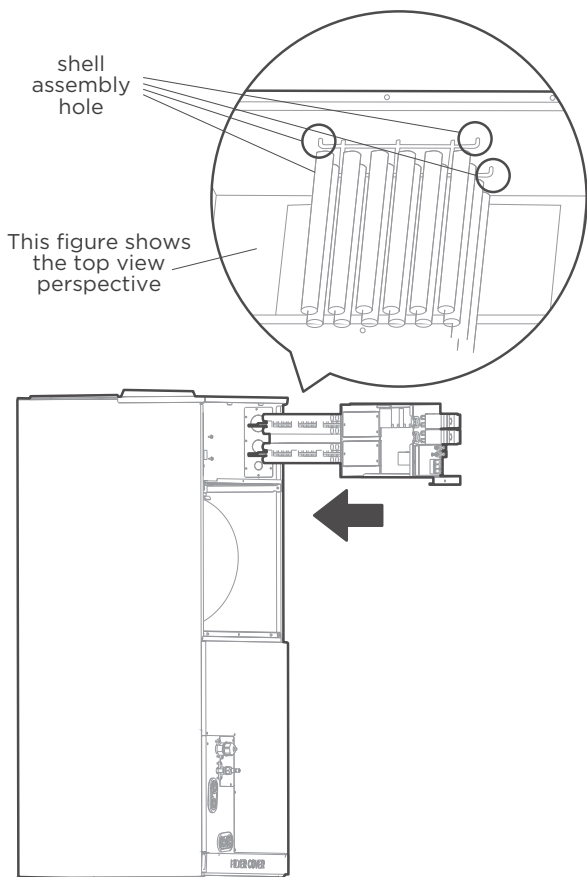

5. Tighten the mounting screws.

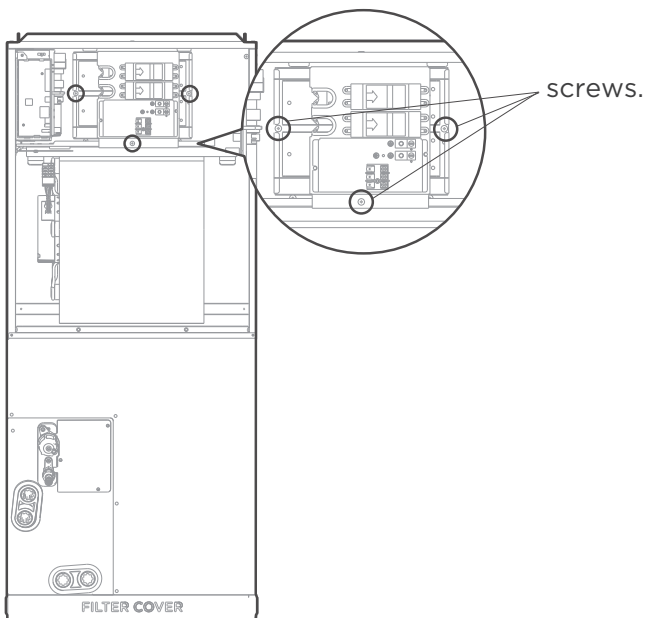

6. Wire according to the wiring nameplate.

Apply the wiring diagram to the inside cover wiring is completed for future reference and maintenance. Plug the electric heating plugs CN11 and CN12 into the main

board.

7. Install the upper cover, and the silicone breaker cover.

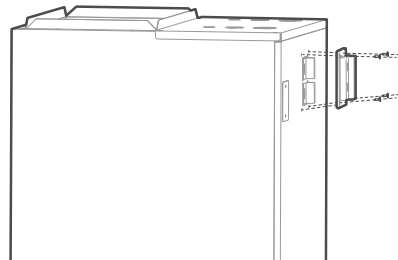

8. After installing the electric auxiliary heat module, apply the circuit breaker label near the silicone breaker cover that was just applied.

NOTE:

The circuit breaker cannot be operated by user.

CONFIRMATION OF INDOOR UNIT

After the electric heating wiring is connected, please confirm before power on:

- Check all wiring and ensure secure connection of all wiring.
- Ensure that wire size is properly selected per NEC or local codes.

Specifications	Number of circuit breakers	Number of relays	Number of power cord groups	Number of power cord grounding screws
3kW	1	1	2	2
5kW	1	1	2	2
8kW	1	2	2	2
10kW	1	2	2	2
15kW	2	3	3	3
20kW	2	4	3	3
25kW	3	5	4	4

NOTICE:

- Electric auxiliary heating wiring diagram packed with the accessories.
- If branch circuit wire length exceeds 100 ft, consult NEC 210-19a to determine maximum wire length. Use 2% voltage drop.

7. Engineering of Electrical Wiring

1. Highlights of electrical wiring installation

- All field wiring construction should be finished by qualified electrician.
- Air conditioning equipment should be grounded according to the local electrical regulations.
- Current leakage protection switch should be installed.
- Do not connect the power wire to the terminal of signal wire.
- When power wire is parallel with signal wire, put wires to their own wire tube and remain at least 300mm/11.8in gap.
- According to table in indoor part named "the specification of the power" to choose the wiring, make sure the selected wiring not small than the date showing in the table.
- Select different colors for different wire according to relevant regulations.
- Do not use metal wire tube at the place with acid or alkali corrosion, adopt plastic wire tube to replace it.
- There must be not wire connect joint in the wire tube If joint is a must, set a connection box at the place.
- The wiring with different voltage should not be in one wire tube.
- Ensure that the color of the wires of outdoor and the terminal No. are same as those of indoor unit respectively.

2. Specific wiring method

Connection method A(recommend):

Refer to the wiring method of internal and external machine communication and wired controller as follows:

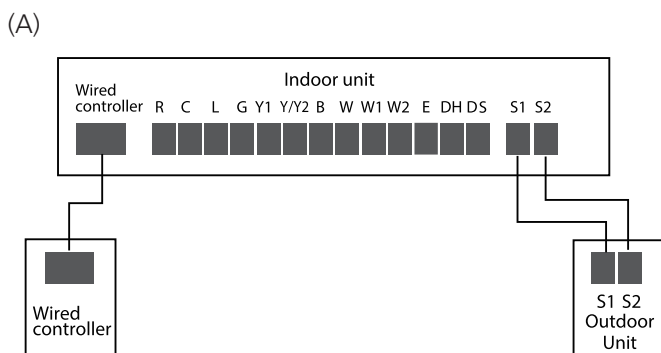

(B)

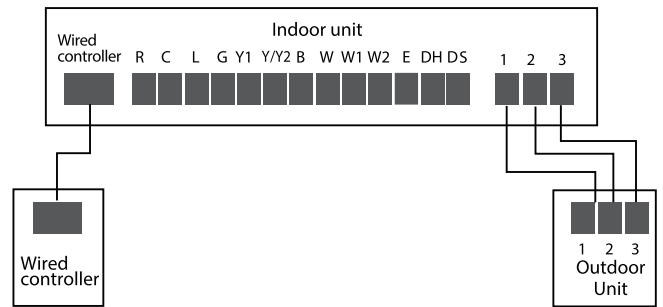

Connection method B:

To use a 24V thermostat, you need to refer to the following wiring:

(A)

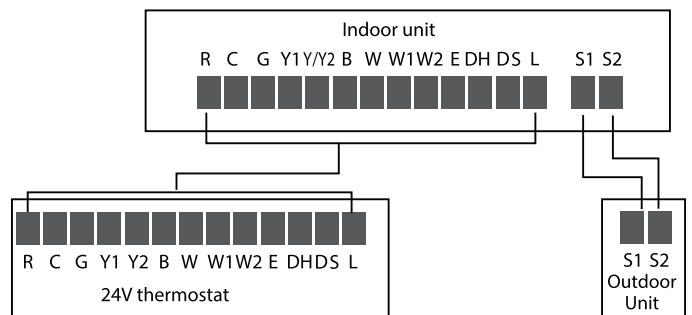

(B)

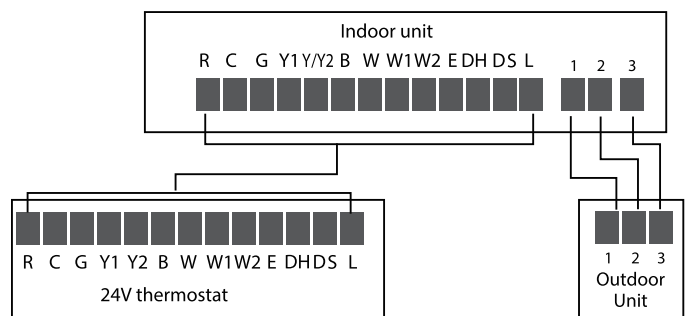

NOTE: The wiring method of the thermostat and the internal machine refers to the wiring of the non-communication scheme.

3. Optional function wiring

3.1 Condensate overflow switch

The unit will accommodate a remote condensate overflow switch. To enable, remove jumper J7, and connect the installer provided condensate overflow device to CN23 per below. When an overflow condition is present, the device should open connection signaling the unit to turn of the system.

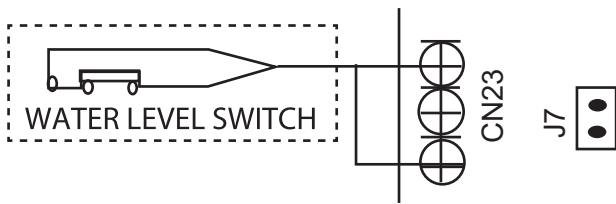

3.2 The fault warning

Alarm output:

An alarm output(CN33) can be utilized if actions are required when a fault is present. This is a passive outlet port, so you will need to input a voltage signal. The relay is normally-open for normal operation, and closed when a fault condition is active.

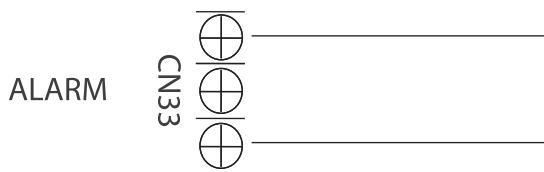

3.3 Humidifier control

- To connect a humidifier, utilize the passive signal "WORK" output (CN23) port as well as the G and C wires on the controller, and wire the humidistat and humidifier per above wiring diagram. When the fan is running, the CN23 relay will be closed, which will allow power to the humidifier when the humidistat is below humidity setpoint. If the thermostat or zone controller has an HUM interface, connect the humidifier directly to the HUM and C ports.

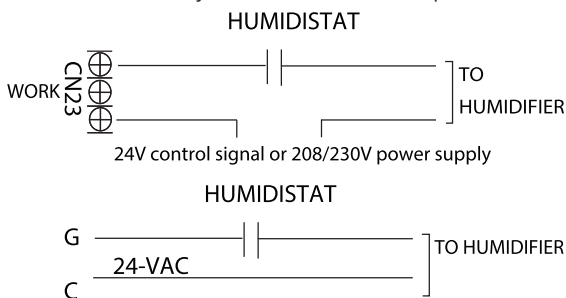

3.4 UV, fresh air or negative ion wiring

The WORK port is linked with the fan. When the fan is running, the relay is closed; if an active 24V signal is required, it can be directly connected to the G and C ports.

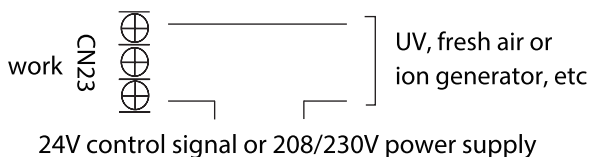

4. Control Logic

Indoor unit Connector

Connector	Purpose
R	24V Power Connection
C	Common
G	Fan Control
Y1	Low Cooling
Y/Y2	High Cooling
B	Heating Reversing Valve
W	Heating Control
W1	Stage 1 Electric heating
W2	Stage 2 Electric heating
E/AUX	Emergency heating
DS	Reserved Signal
L	System Fault Signal

5. KEY1 Instructions (For Wired Controller only)

- Press KEY1 to enter the forced automatic mode, press KEY1 again to enter the forced cooling mode (LED display FC), and press KEY1 again to shut down.
- Long press KEY1 under forced cooling mode (LED display FC) 5s to enter forced defrost mode.

Product Features

Contents

1. 24V Signal Chart	2
2. Safety Features	3
3. Basic Functions.....	3
3.1 Abbreviation	3
3.2 Fan Mode	3
3.3 Cooling Mode.....	3
3.4 Heating Mode(Heat Pump Units).....	4
3.5 Auto Mode	4
3.7 Forced Operation Function	5
3.8 Timer Function	5
3.9 Sleep Function	5
3.10 Auto-Restart Function	5

1. 24V Signal Chart

Mode	Priority	G	Y1	Y/Y2	B	W	W1	W2	E/AUX	DH	Fan speed	Display
OFF	/	0	0	0	0	0	0	0	0	*	OFF	00
FAN	7	1	0	0	*	0	0	0	0	*	Low	01
Cooling stage 1	6	*	1	0	0	0	0	0	0	1	Mid	02
Cooling stage 2		*	*	1	0	0	0	0	0	1	High	03
Dehumidification 1		*	1	0	0	0	0	0	0	0	Low	04
Dehumidification 2		*	*	1	0	0	0	0	0	0	Low	05
Heat pump stage 1	5	*	1	0	1	0	0	0	0	1	Mid	06
Heat pump stage 2		*	*	1	1	0	0	0	0	1	High	
Heat pump stage 2		*	*	*	*	1	0	0	0	1	High	07
Electric heater kit 1	3	*	0	0	*	0	1	0	0	*	Turbo	08
Electric heater kit 2		*	0	0	*	0	0	1	0	*	Turbo	
Electric heater kit 1 and kit 2		*	0	0	*	0	1	1	0	*	Turbo	09
Heat pump stage 1 + Electric heater kit 1	4	*	1	0	1	0	1	0	0	1	Turbo	10
Heat pump stage 1 + Electric heater kit 2		*	1	0	1	0	0	1	0	1	Turbo	
Heat pump stage 2 + Electric heater kit 1		*	*	1	1	0	1	0	0	1	Turbo	
Heat pump stage 2 + Electric heater kit 1		*	*	*	*	1	1	0	0	1	Turbo	
Heat pump stage 2 + Electric heater kit 2		*	*	1	1	0	0	1	0	1	Turbo	
Heat pump stage 2 + Electric heater kit 2		*	*	*	*	1	0	1	0	1	Turbo	
Heat pump stage 1 + Electric heater kit 1 and kit 2	*	1	0	1	0	1	1	0	1	Turbo	11	
Heat pump stage 2 + Electric heater kit 1 and kit 2	*	*	1	1	0	1	1	0	1	Turbo		
Heat pump stage 2 + Electric heater kit 1 and kit 2	*	*	*	*	1	1	1	0	1	Turbo		
Emergency heat	1	*	*	*	*	*	*	*	1	*	Turbo	12
Heating zone control	2	*	1	0	1	0	*	*	0	0	Low	13
Heating zone control		*	*	1	1	0	*	*	0	0	Low	
Heating zone control		*	*	*	*	1	*	*	0	0	Low	

NOTE:

1 : 24V signal 0 : No 24V signal * : 1 or 0

The AHU will turn off if the 24V input cannot meet the table.

Matching With Multi Zone Outdoor Unit

When matching with multi zone outdoor unit, the indoor unit cannot be started due to the mode conflict in the following cases.

Mode Of AHU	Mode Of other IDU zones	Mode Conflict Unit
Fan	Heating/ Electric heat/ Emergency heat	AHU
Cooling		AHU
Dehumidification		AHU
Heating	Fan/Cooling/Dehumidification	Other IDU zones
Electric heat		Other IDU zones
Emergency heat		Other IDU zones

Note:

- When Heating reaches the temperature and shuts down with other IDU zones heating normally, the AHU fan will stop running, and the Fan-ON mode is invalid.
- The heat pump will start synchronously when Emergency heat or Electric heat is started.
- When two AHU units are connected by multi zone outdoor unit, the above rules are applicable while one of the AHU unit regarded as other IDU zones.

2. Safety Features

Indoor fan delayed operation

- When the unit starts, the indoor fan will operate after a period of setting time.
- If the unit is in heating mode, the indoor fan is regulated by the anti-cold wind function.

Sensor redundancy and automatic shutoff

- If one temperature sensor malfunctions, the air conditioner continues operation and displays the corresponding error code, allowing for emergency use.
- When more than one temperature sensor is malfunctioning, the air conditioner ceases operation.

3. Basic Functions

3.1 Abbreviation

Unit element abbreviations

Abbreviation	Element
T1	Indoor room temperature
T2	Coil temperature of evaporator
T3	Coil temperature of condenser
T4	Outdoor ambient temperature
TP	Compressor discharge temperature
TS	Setting temperature
Tsc	Adjusted setting temperature

In this manual, such as CDIFTEMP, HDIFTEMP2, TEH2, TCE1, TCE2...etc., they are well-setting parameter of EEPROM.

3.2 Fan Mode

When fan mode is activated:

- Temperature control is disabled and no temperature setting is displayed.
- The indoor fan speed can be set to low, medium, high, turbo and auto.
- Auto fan: In fan-only mode, AC operates the same as auto fan in cooling mode with the temperature set at 24°C(75°F).
- Under 24V control, when only G signal is available, when switching from heating mode or emergency heating mode to fan mode, $T4 < 10^{\circ}\text{C}(50^{\circ}\text{F})$, the heating mode is sent to the outdoor; when $T4 > 12^{\circ}\text{C}(54^{\circ}\text{F})$, the normal outdoor control is resumed, the fan mode is sent to the outdoor.

3.3 Cooling Mode

3.3.1 Indoor Fan Control

1) In cooling mode, the indoor fan operates continuously. The fan speed can be set to low, medium, high, turbo and auto.

2) Auto fan action in cooling mode:

- Descent curve
 - When T1-Tsc is lower than 3.5°C/6°F, fan speed reduces to high;
 - When T1-Tsc is lower than 1°C/2°F, fan speed reduces to medium;
 - When T1-Tsc is lower than 0.5°C/1°F, fan speed reduces to low;
- Rise curve
 - When T1-Tsc is higher than or equal to 1°C/2°F, fan speed increases to medium;
 - When T1-Tsc is higher than or equal to 1.5°C/3°F, fan speed increases to high;
 - When T1-Tsc is higher than or equal to 4°C/7°F, fan speed increases to turbo.

3.3.2 Condenser Temperature Protection

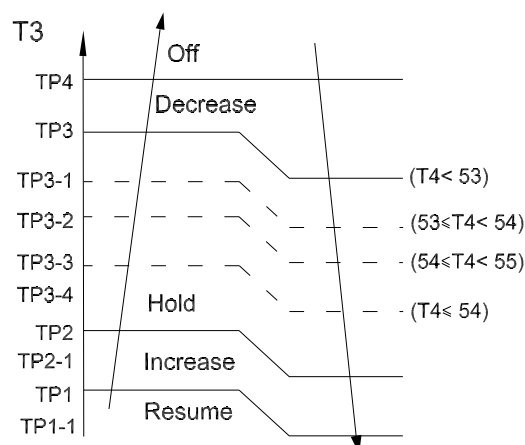

- Off: Compressor stops.
- Decrease: Decrease the running frequency to the lower level at 0.04Hz/s.
- Hold: Keep the current frequency.
- Increase: Increase the running frequency to the higher level at 1Hz/s
- Resume: No limitation for frequency.

3.3.3 Evaporator Temperature Protection

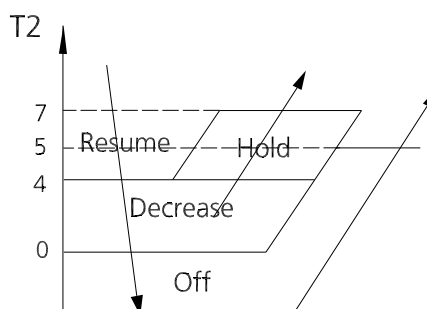

- Off: Compressor stops.
- Decrease: Decrease the running frequency to the lower level per 1 minute.
- Hold: Keep the current frequency.
- Resume: No limitation for frequency.

3.4 Heating Mode(Heat Pump Units)

3.4.1 Indoor Fan Control:

1) In heating mode, the indoor fan operates continuously. The fan speed can be set to low, medium, high, turbo and auto.

- Anti-cold air function
 - The indoor fan is controlled by the indoor temperature T1 and indoor unit coil temperature T2.

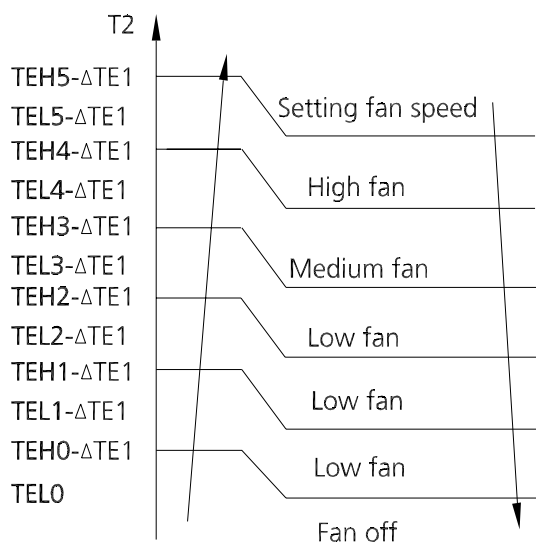

$T1 \geq 19^{\circ}\text{C}(66^{\circ}\text{F})$	$\Delta\text{TE1}=0$
$15^{\circ}\text{C}(59^{\circ}\text{F}) \leq T1 < 19^{\circ}\text{C}(66^{\circ}\text{F})$	$\Delta\text{TE1}=19^{\circ}\text{C}-T1$ ($66^{\circ}\text{F}-T1$)
$T1 < 15^{\circ}\text{C}(59^{\circ}\text{F})$	$\Delta\text{TE1}=4^{\circ}\text{C}(7^{\circ}\text{F})$

2) Auto fan action in heating mode:

- Rise curve
 - When T1-Tsc is higher than $-1.5^{\circ}\text{C}/-3^{\circ}\text{F}$, fan speed reduces to high;
 - When T1-Tsc is higher than $0^{\circ}\text{C}/0^{\circ}\text{F}$, fan speed reduces to medium;
 - When T1-Tsc is higher than $0.5^{\circ}\text{C}/1^{\circ}\text{F}$, fan speed reduces to low;
- Descent curve
 - When T1-Tsc is lower than or equal to $0^{\circ}\text{C}/0^{\circ}\text{F}$, fan speed increases to medium;
 - When T1-Tsc is lower than or equal to $-1.5^{\circ}\text{C}/-3^{\circ}\text{F}$,

fan speed increases to high;

- When T1-Tsc is lower than or equal to $-3^{\circ}\text{C}/-5^{\circ}\text{F}$, fan speed increases to turbo.

3.4.2 Evaporator Coil Temperature Protection

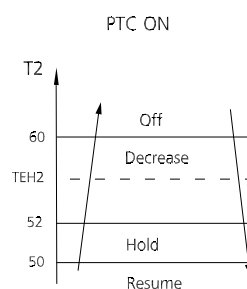
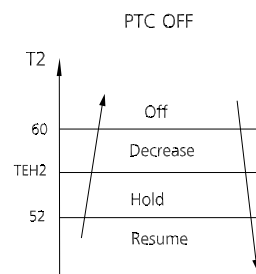

- Off: Compressor stops.
- Decrease: Decrease the running frequency to the lower level per 20 seconds.
- Hold: Keep the current frequency.
- Resume: No limitation for frequency.

3.5 Auto Mode

- This mode can be selected with the remote controller and the temperature setting can be adjusted between $16^{\circ}\text{C}\sim 30^{\circ}\text{C}(61^{\circ}\text{F}\sim 86^{\circ}\text{F})$.
- In auto mode, the machine selects cooling, heating, or fan-only mode on the basis of ΔT ($\Delta\text{T} = T1 - T5$).

ΔT	Running mode
$\Delta\text{T} > 2^{\circ}\text{C}(4^{\circ}\text{F})$	Cooling
$-3^{\circ}\text{C}(-5^{\circ}\text{F}) < \Delta\text{T} \leq 2^{\circ}\text{C}(4^{\circ}\text{F})$	Fan-only
$\Delta\text{T} \leq -3^{\circ}\text{C}(-5^{\circ}\text{F})$	Heating*

Heating*: In auto mode, cooling only models run the fan

- Indoor fan will run at auto fan speed.
- If the machine switches mode between heating and cooling, the compressor will keep stopping for certain time and then choose mode according to ΔT .

3.6 Drying Mode

- In drying mode, AC operates the same as auto fan in cooling mode.
- All protections are activated and operate the same as

they do that in cooling mode.

- Low Room Temperature Protection

If the room temperature is lower than 10°C/50°F, the compressor ceases operations and does not resume until room temperature exceeds 12°C/54°F.

3.7 Forced Operation Function

Press the AUTO/COOL button, the AC will run as below sequence:

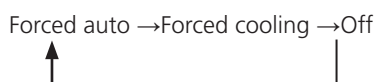

- Forced cooling mode:

The compressor and outdoor fan continue to run and the indoor fan runs at breeze speed. After running for 30 minutes, the AC will switch to auto mode with a preset temperature of 24°C(76°F).

- Forced auto mode:

Forced auto mode operates the same as normal auto mode with a preset temperature of 24°C(76°F).

- The unit exits forced operation when it receives the following signals:
 - Switch off
 - Receive the remote signal to change the running mode:

3.8 Timer Function

- The timing range is 24 hours.
- Timer On. The machine turns on automatically at the preset time.
- Timer Off. The machine turns off automatically at the preset time.
- Timer On/Off. The machine turns on automatically at the preset On Time, and then turns off automatically at the preset Off Time.
- Timer Off/On. The machine turns off automatically at the preset Off Time and then turns on automatically at the preset On Time.
- The timer does not change the unit operation mode. If the unit is off now, it does not start up immediately after the "timer off" function is set. When the setting time is reached, the timer LED switches off and the unit running mode remains unchanged.
- The timer uses relative time, not clock time

3.9 Sleep Function

- The sleep function is available in cooling, heating, auto mode or Heat pump + Electric heater.
- The operational process for sleep mode is as follows:
 - When cooling, the set temperature rises by 1°C/2°F

(to not higher than 30°C/86°F) every hour. After 2 hours, the temperature stops rising and the indoor fan is fixed at low speed.

- When heating, the set temperature decreases by 1°C/2°F(to not lower than 16°C/61°F) every hour. After 2 hours, the temperature stops decreasing and the indoor fan is fixed at low speed. Anti-cold wind function takes priority.
- When in auto mode, the fan speed is also fixed at low speed. After 1 hour, if the actual operation mode is cooling mode, the set temperature will rise by 1°C/2°F, if it is heating mode, the set temperature will decrease by 1°C/2°F, if it is fan mode, the set temperature will not change, and the set temperature will not change after two hours of operation.
- The timer setting is available in this mode.

3.10 Auto-Restart Function

- The indoor unit has an auto-restart module that allows the unit to restart automatically. The module automatically stores the current settings and in the case of a sudden power failure, will restore those setting automatically within 3 minutes after power returns.

Troubleshooting

Contents

1. Safety Caution	3
2. General Troubleshooting.....	4
2.1 Error Display (Indoor Unit)	4
2.2 Error Display on Two Way Communication Wired Controller	5
3. Engineering Mode	6
3.1 Information Inquiry	6
3.2 Advanced Function Setting	9
4. Error Diagnosis and Troubleshooting Without Error Code.....	12
4.1 Remote maintenance	12
4.2 Field maintenance.....	13
5. Quick Maintenance by Error Code.....	18
6. Troubleshooting by Error Code.....	19
6.1 EH 00/ EH 0A / EC 51 (EEPROM Malfunction Error Diagnosis and Solution)	19
6.2 EL 01 (Indoor and Outdoor Unit Communication Error Diagnosis and Solution)	20
6.3 EH 03 / EC 07 (Fan Speed Is Operating Outside of Normal Range Diagnosis and Solution) 23	
6.4 EH 60/EH 61/EH 62/EH 66/EH 65/EC 53/EC 52/EC 54/EC 56 (Open Circuit or Short Circuit of Temperature Sensor Diagnosis and Solution)	25
6.5 EL 0C (System lacks refrigerant Diagnosis and Solution)	26
6.6 EH 0E(Water-Level Alarm Malfunction Diagnosis and Solution)	27
6.7 PC 00(ODU IPM module protection Diagnosis and Solution).....	28
6.8 PC 01(ODU voltage protection Diagnosis and Solution).....	29

Troubleshooting

Contents

6.9	PC 04(Inverter compressor drive error Diagnosis and Solution).....	30
6.10	PC 03(Pressure protection(low or high pressure) Diagnosis and Solution).....	31
6.11	PC 02(Compressor top (or IPM) temp. protection diagnosis and solution).....	34
6.12	PC 0L (Low ambient temperature protection)	35
6.13	EH b3 (Communication malfunction between wire and master control) Diagnosis and Solution 36	
6.14	EH bA(Communication malfunction between indoor unit and external fan module)/EH 3A(External fan DC bus voltage is too low protection)/ EH 3b(External fan DC bus voltage is too high fault) diagnosis and solution.....	37
6.15	FH CC(Refrigerant sensor error) or EH C3(Refrigerant sensor is out of range) diagnosis and solution	38
6.16	EH C1(Refrigerant sensor detects leakage) or EH C2(Refrigerant sensor is out of range and leakage is detected) diagnosis and solution	39
6.17	EC 0d(ODU malfunction Diagnosis and Solution).....	40
6.18	EH 0b(IDU main control board and display board communication error diagnosis and solution)41	
6.19	EL 16(Communication malfunction between adapter board and outdoor main board diagnosis and solution).....	42
6.20	FL 09(Mismatch between the new and old platforms diagnosis and solution).....	42

7. Check Procedures

1. Safety Caution

WARNING

Be sure to turn off all power supplies or disconnect all wires to avoid electric shock. While checking indoor/outdoor PCB, please equip oneself with antistatic gloves or wrist strap to avoid damage to the board.

WARNING

Electricity remains in capacitors even when the power supply is off. Ensure the capacitors are fully discharged before troubleshooting.

2. General Troubleshooting

2.1 Error Display (Indoor Unit)

When the indoor unit encounters a recognized error, the operation lamp will flash in a corresponding series, the timer lamp may turn on or begin flashing, and an error code will be displayed. These error codes are described in the following table:

Display	Error Information	Solution
EC 01	ODU fan speed out of control	TS23
EC 0d	ODU malfunction	TS40
EC 51	ODU EEPROM parameter error	TS19
EC 52	ODU coil temp. sensor (T3) error	TS25
EC 53	ODU ambient temp. sensor (T4) error	TS25
EC 54	COMP. discharge temp. sensor(TP) error	TS25
EC 56	IDU coil outlet temp. sensor(T2B) error(Multi-zone)	TS25
EC C1	Other IDU refrigerant sensor detects leakage (Multi-zone)	TS39
EH 00	IDU EEPROM malfunction	TS19
EH 03	IDU fan speed out of control	TS23
EH 0A	IDU EEPROM parameter error	TS19
EH 0b	IDU main control board and display board communication error	TS41
EH 0E	Water-level alarm malfunction	TS27
EH 3A	External fan DC bus voltage is too low protection	TS37
EH 3b	External fan DC bus voltage is too high fault	TS37
EH 60	IDU room temp. sensor (T1) error	TS25
EH 61	IDU coil temp. sensor(T2) error	TS25
EH 62/EH 66	Evaporator coil inlet temperature sensor T2B is in open circuit or short circuit	TS25
EH 65	Evaporator coil temperature sensor T2A is in opencircuit or short circuit	TS25
EH bA	Communication malfunction between indoor unit and external fan module	TS37
EH C1	Refrigerant sensor detects leakage	TS39

EH C2	Refrigerant sensor is out of range and leakage is detected	TS39
EH C3	Refrigerant sensor is out of range	TS38
EL 01	IDU & ODU communication error	TS20
EL 0C	System lacks refrigerant	TS24
EL 16	Communication malfunction between adapter board and outdoor main board	TS42
FH CC	Refrigerant sensor error	TS38
FL 09	Mismatch between the new and old platforms	TS42
PC 00	ODU IPM module protection	TS28
PC 01	ODU voltage protection	TS29
PC 02	Compressor top (or IPM) temp. protection	TS34
PC 03	Pressure protection (low or high pressure)	TS31
PC 04	Inverter compressor drive error	TS30
PC 0L	Low ambient temperature protection	TS35
----	IDUs mode conflict(Multi-zone)	--

For other errors:

The display board may show a garbled code or a code undefined by the service manual. Ensure that this code is not a temperature reading.

Troubleshooting:

Test the unit using the remote control. If the unit does not respond to the remote, the indoor PCB requires replacement. If the unit responds, the display board requires replacement.

LED flash frequency:

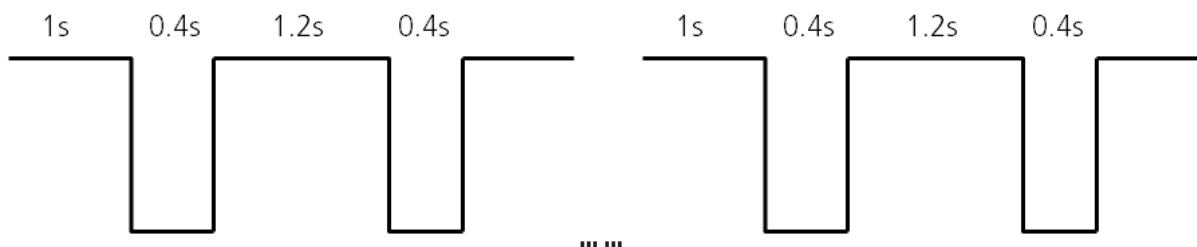

2.2 Error Display on Two Way Communication Wired Controller

Display	Malfunction or Protection	Solution
EH b3	Communication malfunction between wire and master control((for KJR-120X/KJR-120M/ KJR-120N series wired controller)	TS36

The other error codes displayed on the wire controller are same from those on the unit.

3. Engineering Mode

3.1 Information Inquiry

In order to enter to the engineering mode, and check the data of the system (data checking mode), Please make the following steps:

- Make sure that the AC is on the standby status, or working normally in a non-locked conditions.
- Press "Power" + "Fan" buttons together for 7s until the remote controller screen shows "0", and also "Auto, Cool, Dry, Heat, Battery" icons will be displayed at the same time.
- Press "Up" or "Down" button to choose different channel number that you want to check (from 0-30) on the remote controller, and then the display will show the parameter value

Channel	Code	Meaning	Remark
0		Error code	Refer to next list of error code Empty means no error
1	T1	Room temperature	Actual data, °C/°F
2	T2	Indoor coil temperature	Actual data, °C/°F
3	T3	Outdoor coil temperature	Actual data, °C/°F
4	T4	Ambient temperature	Actual data, °C/°F
5	TP	Discharge temperature	Actual data, °C/°F
6	FT	Targeted frequency	Actual data
7	Fr	Actual frequency	Actual data
8	dL	Running current	3.2A=3
9	Ac	AC voltage	
10	Sn	Reserved	
11	nA	Reserved	
12	Pr	Indoor air flow	Actual data/10
13	Lr	EXV opening steps	Actual data/8
14	lr	Indoor fan speed	Actual data/8
15	Hu	Humidity (if a sensor there)	Actual data, %
16	TT	Set temperature including compensation	Actual data, °C
17	nA	Reserved	
18	nA	Reserved	
19	Uo	Outdoor DC bus voltage	
20	oT	Target Frequency calculated by indoor	Without limitation
21~30	nA	Reserved	

Please note that:

1-The Channel number indicates a certain parameter value (Check the below table).

2-The indoor unit display will show the code for 2s, and then the parameter value.

3-In the engineering mode, the other keys or operations are invalid except for the following buttons "Power", "Up", "Down", and "OK".

4-In order to exit from the engineering mode, press "Power" + "Fan" buttons together for 2s to quit Checking and back to the home screen.

5-The engineering mode will be exited if there is no valid input data for 60s.

Error code of engineer mode

Display	Error Information
E400	IDU EEPROM malfunction
E40A	IDU EEPROM parameter error
E401	IDU & ODU communication error
E46A	Communication error between indoor unit and external fan module
E430	Parameters error of indoor external fan
E435	Phase failure of indoor external fan
E436	Indoor external fan current sampling bias fault
E437	Indoor external fan zero speed failure
E438	Indoor external fan stall failure
E439	Out of step failure of indoor external fan
E43A	Low voltage protection of indoor external fan DC bus
E43B	Indoor external fan DC bus voltage is too high fault
E43E	Indoor external fan overcurrent fault
E43F	Indoor external fan module protection/hardware overcurrent protection
E403	IDU fan speed out of control
E451	ODU EEPROM parameter error
E452	ODU coil temp. sensor (T3) error
E453	ODU ambient temp. sensor (T4) error
E454	COMP. discharge temp. sensor(TP) error
E455	IGBT temperature sensor TH is in open circuit or short circuit
E40d	Outdoor unit malfunction
E460	IDU room temp. sensor (T1) error
E461	IDU coil temp. sensor(T2) error
E471	Outdoor external fan overcurrent fault
E475	Outdoor external fan module protection/hardware overcurrent protection
E472	Outdoor external fan phase failure
E474	Outdoor external fan current sampling bias fault
E473	Zero speed failure of outdoor unit DC fan
E407	ODU fan speed out of control
E4b5	Intelligent eye communication failure
E40C	Refrigerant leak detected
E40E	Water-level alarm malfunction
E40F	Intelligent eye malfunction
F407	Communication malfunction between indoor unit and auto-lifting panel
P400	ODU IPM module protection
P410	Over low voltage protection
P411	Over voltage protection
P412	DC voltage protection
P402	Top temperature protection of compressor or High temperature protection of IPM module
P440	Communication error between outdoor main chip and compressor driven chip

PC 41	Current Input detection protection
PC 42	Compressor start error
PC 43	Lack of phase (3 phase) protection
PC 44	Outdoor unit zero speed protection
PC 45	341PWM error
PC 46	Compressor speed malfunction
PC 49	Compressor over current protection
PC 06	Compressor discharge temperature protection
PC 08	Outdoor current protection
PH 09	Anti-cold air in heating mode
PC 0F	PFC module malfunction
PC 30	System overpressure protection
PC 31	System pressure is too low protection
PC 03	Pressure protection
PC 0L	Outdoor low ambient temperature protection
PH 90	Evaporator coil temperature over high protection
PH 91	Evaporator coil temperature over low Protection
PC 0R	Condenser high temperature protection
PH 0C	Indoor unit humidity sensor failure
LM 00	Frequency limit caused by T2
LM 30	Indoor external fan current limit
LM 31	Indoor external fan voltage limit
LC 01	Frequency limit caused by T3
LC 02	Frequency limit caused by TP
LC 05	Frequency limit caused by voltage
LC 03	Frequency limit caused by current
LC 06	Frequency limit caused by PFC
LC 30	Frequency limit caused by high pressure
LC 31	Frequency limit caused by low pressure
LM 07	Frequency limit caused by remote controller
--	IDUs mode conflict(match with multi outdoor unit)
NR	No malfunction and protection

3.2 Advanced Function Setting

In order to enter to the engineering mode, and check the advanced function settings, Please make the following steps:

If you want to check the current functions set value (Presetting Page):

- 1- Firstly, you need to disconnect the power supply from the unit, and wait for 1 minute.
- 2- Then connect the power supply again to the unit (the unit should be under the standby state).
- 3- Press "Power" + "Fan" buttons together for 7s until the remote controller screen shows "0", and also "Auto, Cool, Dry, Heat, Battery" icons will be displayed at the same time.
- 4- Press "Up" or "Down" button to choose different channel number that you want to check (from 0-30) on the remote controller.
- 5- Then Press "Power" button for 2s until the remote controller screen shows "Ch" .
- 6- Press "OK" button to query the current function set value while the remote controller shows "CH", and the function set value will be shown on the indoor unit display.

If you want to change the current functions set value:

- 1- Firstly, you need to disconnect the power supply from the unit, and wait for 1 minute.
- 2- Then connect the power supply again to the unit (the unit should be under the standby state).
- 3- Press "Power" + "Fan" buttons together for 7s until the remote controller screen shows "0", and also "Auto, Cool, Dry, Heat, Battery" icons will be displayed at the same time.
- 4- Press "Up" or "Down" button to choose different channel number that you want to change (from 0-30) on the remote controller.
- 5- Then Press "Power" button for 2s until the remote controller screen shows "Ch" .
- 6- Press "Up" or "Down" button to choose the desired set value from the screen of the remote control.
- 7- Then Press "OK" to send the new set value to the indoor unit, and the indoor unit will display "CS", which means that the new set value is uploaded successfully.
- 8- Finally, disconnect the power supply again from the unit, and wait for 10 minutes, then connect it again.

Please note that:

- 1- The Channel number indicates a certain function, and each number will be showed on the indoor unit screen indicates the current function set value (Check the below table).
- 2- In the engineering mode, the other keys or operations are invalid except for the following buttons "Power", "Up", "Down", and "Ok".
- 3- In order to set a new set value successfully, you need to finish the steps (from 2 to 7) within 1 minute only.
- 4- The engineering mode will be exited if there is no valid input data for 60s.
- 5- In order to exit from the engineering mode, Please follow the following steps:
 - Press "Power" button for 2s press until the remote controller screen shows "0".
 - Then Press "Power" + "Fan" buttons together for 2s to quit the engineering mode and back to the home screen.

Channel	Function	Parameter Value Meaning	Remark
0	Capacity setting (Btu/h)	1-100K	
1	Auto-restart function	0 – Inactive 1 – Active	
2	Fan control when Ts reached	1- Fan stop 2 - Fan runs at lowest RPM 3 - Fan runs at setting RPM 4 - Fan stops for 4 mins and runs for 1mins 5 - Fan stops for 8 mins and runs for 1mins 6 - Fan stops for 16 mins and runs for 1mins 7 - Fan stops for 24 mins and runs for 1mins 8 - Fan stops for 48 mins and runs for 1mins 9 - Fan stops for 15 mins and runs for 2.5mins 10 - Fan stops for 30 mins and runs for 2.5mins 11 - Fan stops for 60 mins and runs for 2.5 12- Fan runs at setting RPM, but stop if choose Automatic speed 13- Fan runs at the lowest speed, but stop if choose Automatic speed	
3	Mode lock	CH–Cooling and heating (all modes) HH–Heating only (Heating + Fan only) CC–Cooling only (Cooling + Drying + Fan only) nU–Cooling and heating without Auto	Remote controller will change as well.
4	Lowest setting temperature	16-24	Remote controller will change as well.
5	Highest setting temperature	25-30	Remote controller will change as well.
6	Reserved	Nothing to set	
7	/	Nothing to set	
8	/	Nothing to set	
9	/	Nothing to set	
10	/	Nothing to set	
11	Min. frequency limitation in cooling mode	10, 11, 12, ..., 49, 50, -- (Cancel)	
12	Min. frequency limitation in heating mode	10, 11, 12, ..., 49, 50, -- (Cancel)	
13	Max frequency selection in T4 limitation of Zone6	20, 21, 22, ..., 149, 150, -- (Cancel)	
14	/	Nothing to set	
15	Frequency selection of outdoor forced-operation	10, 11, 12, ..., 249, 250, -- (Cancel)	
16	One button reset	rS – Reset	
17	nA	Nothing to set	

18	Capacity setting(kW)	23,26,32,35,51,72,120,-- (Cancel)	
19	Max. frequency selection in cooling mode	40, 41, 42, ..., 83, 84, -- (Cancel)	
20	Max. frequency selection in heating mode	40, 41, 42, ..., 83, 84, -- (Cancel)	Without limitation
21	Cooling temperature compensation	-3.0, -2.5, -2.0, ..., 3.0, 3.5, -- (Cancel)	
22	Heating temperature compensation	-6.5, -6.0, -5.5, ..., 0.5, 1.0, 1.5, ..., 7.0, 7.5, -- (Cancel)	
23	Fan volume selection in cooling	Fan volume will add set data*20cfm.	
24	Reserved	Nothing to set	
25	Fan volume selection in heating	Fan volume will add set data*20cfm.	
26	Reserved	Nothing to set	
27	Defrosting type	A0-Normal defrosting A1-Enhanced defrosting	
28	Anti-cold air Stop Fan Temperature	16~28	
29	Reserved	Nothing to set	
30	Reserved	Nothing to set	

4. Error Diagnosis and Troubleshooting Without Error Code



WARNING

Be sure to turn off unit before any maintenance to prevent damage or injury.

4.1 Remote maintenance

SUGGESTION: When troubles occur, please check the following points with customers before field maintenance.

No.	Problem	Solution
1	Unit will not start	TS14 - TS15
2	The power switch is on but fans will not start	TS14 - TS15
3	The temperature on the display board cannot be set	TS14 - TS15
4	Unit is on but the wind is not cold(hot)	TS14 - TS15
5	Unit runs, but shortly stops	TS14 - TS15
6	The unit starts up and stops frequently	TS14 - TS15
7	Unit runs continuously but insufficient cooling(heating)	TS14 - TS15
8	Cool can not change to heat	TS14 - TS15
9	Unit is noisy	TS14 - TS15

4.2 Field maintenance

	Problem	Solution
1	Unit will not start	TS16 - TS17
2	Compressor will not start but fans run	TS16 - TS17
3	Compressor and condenser (outdoor) fan will not start	TS16 - TS17
4	Evaporator (indoor) fan will not start	TS16 - TS17
5	Condenser (Outdoor) fan will not start	TS16 - TS17
6	Unit runs, but shortly stops	TS16 - TS17
7	Compressor short-cycles due to overload	TS16 - TS17
8	High discharge pressure	TS16 - TS17
9	Low discharge pressure	TS16 - TS17
10	High suction pressure	TS16 - TS17
11	Low suction pressure	TS16 - TS17
12	Unit runs continuously but insufficient cooling	TS16 - TS17
13	Too cool	TS16 - TS17
14	Compressor is noisy	TS16 - TS17
15	Horizontal louver can not revolve	TS16 - TS17

1.Remote Maintenance	Electrical Circuit				Refrigerant Circuit															
Possible causes of trouble	Power failure																			
	The main power tripped																			
	Loose connections																			
	Faulty transformer																			
	The voltage is too high or too low																			
	The remote control is powered off																			
	Broken remote control																			
	Dirty air filter																			
	Dirty condenser fins																			
	The setting temperature is higher/lower than the room's(cooling/heating)																			
	The ambient temperature is too high/low when the mode is cooling/heating																			
	Fan mode																			
SILENCE function is activated(optional function)																				
Frosting and defrosting frequently																				
Unit will not start	☆	☆	☆	☆																
The power switch is on but fans will not start			☆	☆	☆															
The temperature on the display board cannot be set						☆	☆													
Unit is on but the wind is not cold(hot)										☆	☆	☆								
Unit runs, but shortly stops					☆					☆	☆									
The unit starts up and stops frequently					☆						☆	☆						☆		
Unit runs continuously but insufficient cooling(heating)									☆	☆	☆	☆			☆					
Cool can not change to heat																				
Unit is noisy																				
Test method / remedy	Test voltage																			
	Close the power switch																			
	Inspect connections - tighten																			
	Change the transformer																			
	Test voltage																			
	Replace the battery of the remote control																			
	Replace the remote control																			
	Clean or replace																			
	Clean																			
	Adjust the setting temperature																			
	Turn the AC later																			
	Adjust to cool mode																			
Turn off SILENCE function.																				
Turn the AC later																				

1.Remote Maintenance	Others					
Possible causes of trouble	Heavy load condition	Loosen hold down bolts and / or screws	Bad airproof	The air inlet or outlet of either unit is blocked	Interference from cell phone towers and remote boosters	Shipping plates remain attached
	Unit will not start					
	The power switch is on but fans will not start				☆	
	The temperature on the display board cannot be set					
	Unit is on but the wind is not cold(hot)					
	Unit runs, but shortly stops					
The unit starts up and stops frequently				☆		
Unit runs continuously but insufficient cooling(heating)	☆		☆	☆		
Cool can not change to heat						
Unit is noisy		☆			☆	
Test method / remedy	Check heat load	Tighten bolts or screws	Close all the windows and doors	Remove the obstacles	Reconnect the power or press ON/OFF button on remote control to restart operation	Remove them

2.Field Maintenance	Refrigerant Circuit														Others									
Possible causes of trouble	Compressor stuck	Shortage of refrigerant	Restricted liquid line	Dirty air filter	Dirty evaporator coil	Insufficient air through evaporator coil	Overcharge of refrigerant	Dirty or partially blocked condenser	Air or incompressible gas in refrigerant cycle	Short cycling of condensing air	High temperature condensing medium	Insufficient condensing medium	Broken compressor internal parts	Inefficient compressor	Expansion valve obstructed	Expansion valve or capillary tube closed completely	Leaking power element on expansion valve	Poor installation of feeler bulb	Heavy load condition	Loosen hold down bolts and / or screws	Shipping plates remain attached	Poor choices of capacity	Contact of piping with other piping or external plate	
Unit will not start																								
Compressor will not start but fans run	☆																							
Compressor and condenser (outdoor) fan will not start																								
Evaporator (indoor) fan will not start																								
Condenser (Outdoor) fan will not start																								
Unit runs, but shortly stops		☆	☆				☆	☆								☆	☆							
Compressor short-cycles due to overload		☆					☆	☆																
High discharge pressure							☆	☆	☆	☆	☆	☆												
Low discharge pressure		☆												☆										
High suction pressure							☆							☆				☆	☆					
Low suction pressure		☆	☆	☆	☆	☆								☆	☆	☆								
Unit runs continuously but insufficient cooling		☆	☆	☆	☆	☆		☆	☆	☆				☆					☆			☆		
Too cool																								
Compressor is noisy							☆						☆							☆	☆		☆	
Horizontal louver can not revolve																								
Test method / remedy	Replace the compressor	Leak test	Replace restricted part	Clean or replace	Clean coil	Check fan	Change charged refrigerant volume	Clean condenser or remove obstacle	Purge, evacuate and recharge	Remove obstruction to air flow	Remove obstruction in air or water flow	Remove obstruction in air or water flow	Replace compressor	Test compressor efficiency	Replace valve	Replace valve	Replace valve	Fix feeler bulb	Check heat load	Tighten bolts or screws	Remove them	Choose AC of larger capacity or add the number of AC	Rectify piping so as not to contact each other or with external plate	

2.Field Maintenance	Electrical Circuit														
Possible causes of trouble	Power failure	Blown fuse or varistor	Loose connections	Shorted or broken wires	Safety device opens	Faulty thermostat / room temperature sensor	Wrong setting place of temperature sensor	Faulty transformer	Shorted or open capacitor	Faulty magnetic contactor for compressor	Faulty magnetic contactor for fan	Low voltage	Faulty stepping motor	Shorted or grounded compressor	Shorted or grounded fan motor
Unit will not start	☆	☆	☆	☆	☆			☆							
Compressor will not start but fans run				☆		☆			☆	☆				☆	
Compressor and condenser (outdoor) fan will not start				☆		☆				☆					
Evaporator (indoor) fan will not start				☆					☆		☆				☆
Condenser (Outdoor) fan will not start				☆		☆			☆		☆				☆
Unit runs, but shortly stops										☆		☆			
Compressor short-cycles due to overload										☆		☆			
High discharge pressure															
Low discharge pressure															
High suction pressure															
Low suction pressure															
Unit runs continuously but insufficient cooling															
Too cool						☆	☆								
Compressor is noisy															
Horizontal louver can not revolve			☆	☆									☆		
Test method / remedy	Test voltage	Inspect fuse type & size	Inspect connections - tighten	Test circuits with tester	Test continuity of safety device	Test continuity of thermostat / sensor & wiring	Place the temperature sensor at the central of the air inlet grille	Check control circuit with tester	Check capacitor with tester	Test continuity of coil & contacts	Test continuity of coil & contacts	Test voltage	Replace the stepping motor	Check resistance with multimeter	Check resistance with multimeter

5. Quick Maintenance by Error Code

If you do not have the time to test which specific parts are faulty, you can directly change the required parts according to the error code.

You can find the parts to replace by error code in the following table.

Part requiring replacement	Error Code										
	EH00/EH0R	EH01	EH03	EH60	EH61	EH62/EH66	EH65	EH0C	EH0I/EH0E	EH0E	EH0b
Indoor PCB	✓	✓	✓	✓	✓	✓	✓	✓	x	✓	✓
Outdoor PCB	x	✓	x	x	x	x	x	x	x	x	x
Indoor fan motor	x	x	✓	x	x	x	x	x	x	x	x
T1 sensor	x	x	x	✓	x	x	x	x	x	x	x
T2 sensor	x	x	x	x	✓	x	x	✓	x	✓	x
T2B sensor	x	x	x	x	x	✓	x	x	x	x	x
T2A sensor	x	x	x	x	x	x	✓	x	x	x	x
Reactor	x	✓	x	x	x	x	x	x	x	x	x
Compressor	x	x	x	x	x	x	x	x	x	x	x
Additional refrigerant	x	x	x	x	x	x	x	✓	✓	✓	x
Water-level switch	x	x	x	x	x	x	x	x	x	✓	x
Water pump	x	x	x	x	x	x	x	x	x	✓	x
Display board	x	x	x	x	x	x	x	x	x	x	✓

Part requiring replacement	EC54	EC51	EC52	EC53	EC56	EC07	PC00	PC01	PC02	PC04	PC03	PH0C/PH0E
Indoor PCB	x	x	x	x	x	x	x	x	x	x	x	✓
Outdoor PCB	✓	✓	✓	✓	✓	✓	✓	✓	✓	✓	✓	x
Outdoor fan motor	x	x	x	x	x	✓	✓	x	✓	✓	x	x
T3 sensor	x	x	✓	x	x	x	x	x	x	x	x	x
T4 sensor	x	x	x	✓	x	x	x	x	x	x	x	x
TP sensor	✓	x	x	x	x	x	x	x	x	x	x	x
T2B sensor	x	x	x	x	✓	x	x	x	x	x	x	x
Refrigerant sensor	x	x	x	x	x	x	x	x	x	x	x	✓
Reactor sensor	x	x	x	x	x	x	x	✓	x	x	x	x
Compressor	x	x	x	x	x	x	✓	x	x	✓	x	x
IPM module board	x	x	x	x	x	x	✓	✓	✓	✓	x	x
Pressure protector	x	x	x	x	x	x	x	x	x	x	✓	x
Additional refrigerant	x	x	x		x	x	x	x	x	x	✓	x

6. Troubleshooting by Error Code

6.1 EH 00/ EH 0A / EC 51 (EEPROM Malfunction Error Diagnosis and Solution)

Description: Indoor or outdoor PCB main chip does not receive feedback from EEPROM chip.

Recommended parts to prepare:

- Indoor PCB
- Outdoor PCB

Troubleshooting and repair:

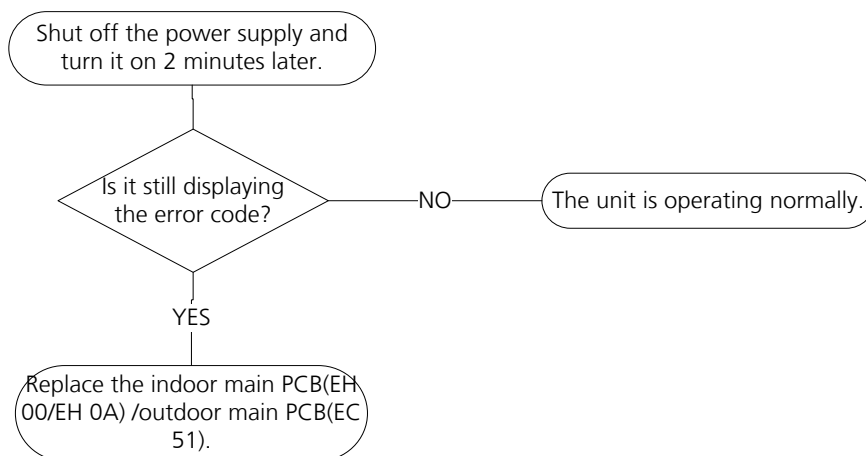

Remarks:

EEPROM: A read-only memory whose contents can be erased and reprogrammed using a pulsed voltage.

The location of the EEPROM chip on the indoor and outdoor PCB is shown in the following two images:

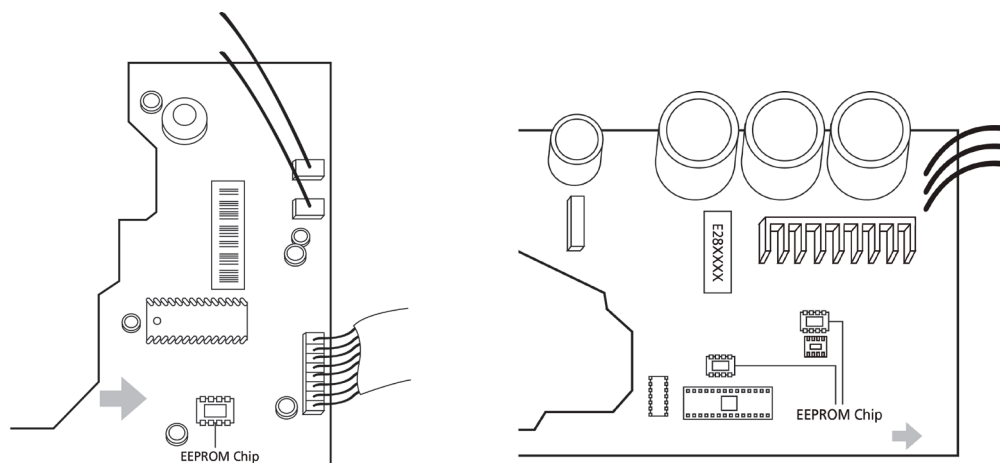

This pictures are only for reference, actual appearance may vary.

Troubleshooting and repair of compressor driven chip EEPROM parameter error and communication error between outdoor main chip and compressor driven chip are same as EC 51.

6.2 EL 01 (Indoor and Outdoor Unit Communication Error Diagnosis and Solution)

Description: Indoor unit can not communicate with outdoor unit

Recommended parts to prepare:

- Indoor PCB
- Outdoor PCB
- Reactor

Troubleshooting and repair:

Current loop Communication(S Communication):

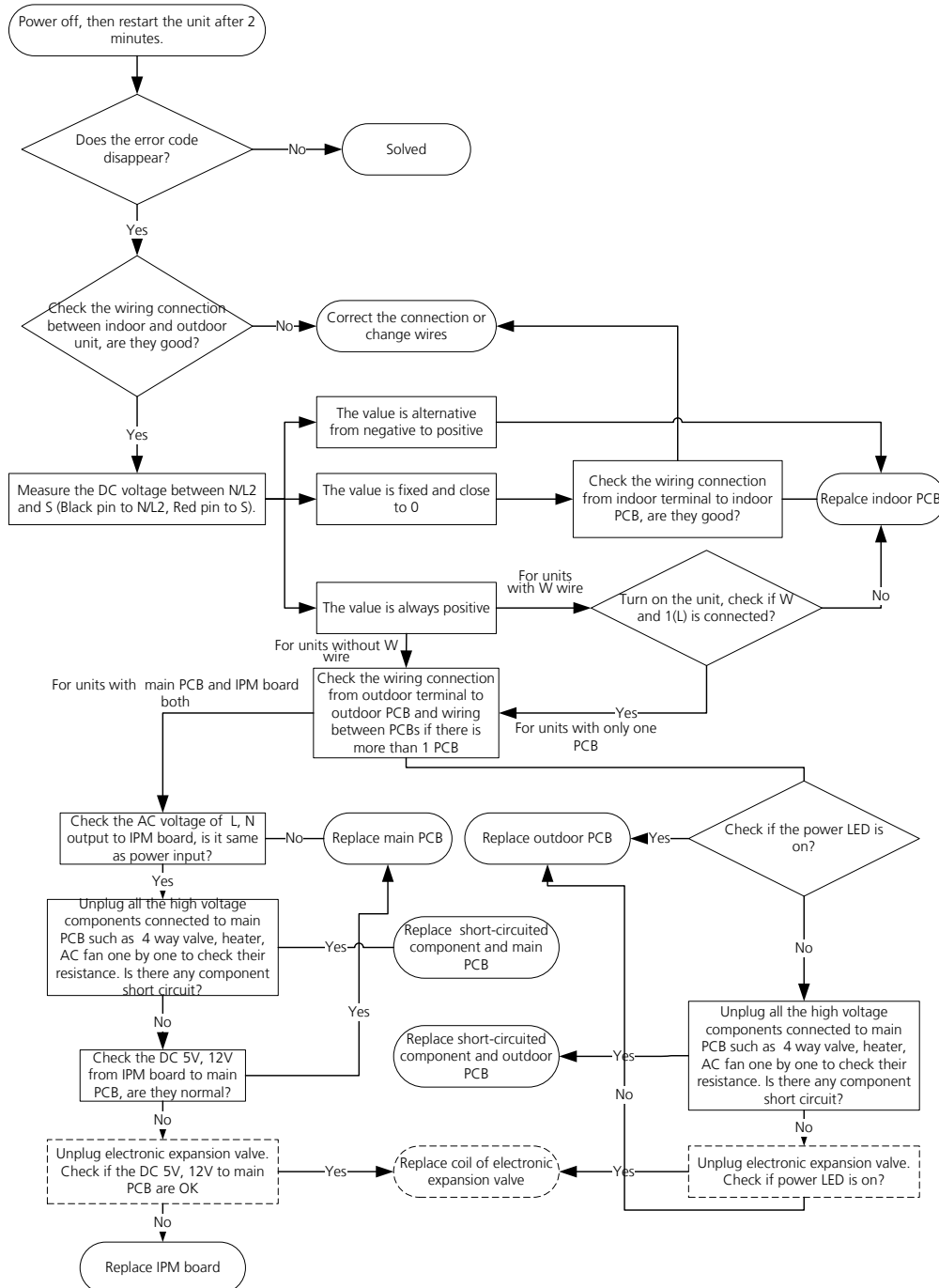

Remarks:

- Use a multimeter to test the DC voltage between 2 port(or S or L2 port) and 3 port(or N or S port) of outdoor unit. The red pin of multimeter connects with 2 port(or S or L2 port) while the black pin is for 3 port(or N or S port).
- When AC is operating normally, the voltage is moving alternately as positive values and negative values
- If the outdoor unit has malfunction, the voltage has always been the positive value.
- While if the indoor unit has malfunction, the voltage has always been a certain value.

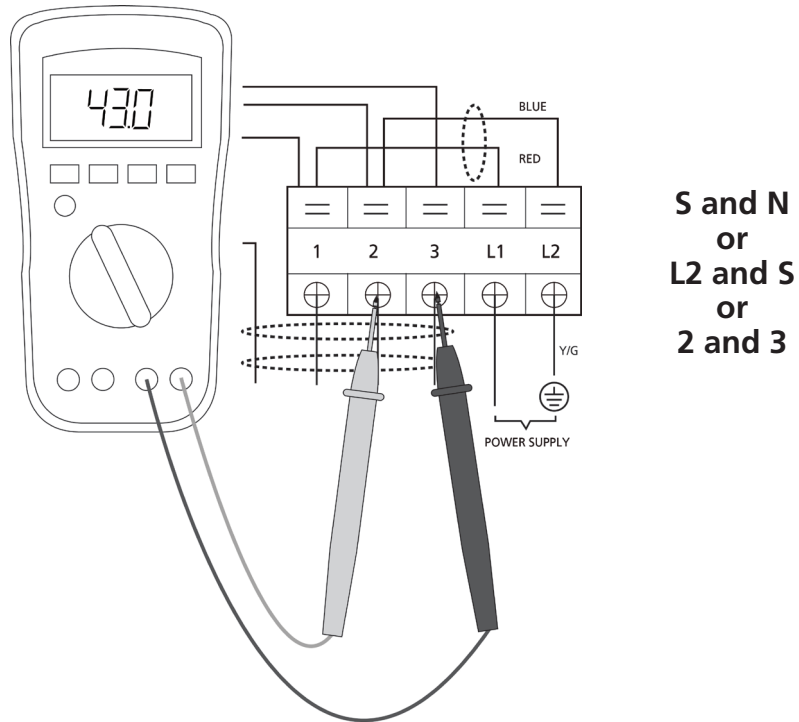

- Use a multimeter to test the resistance of the reactor which does not connect with capacitor.
- The normal value should be around zero ohm. Otherwise, the reactor must have malfunction.

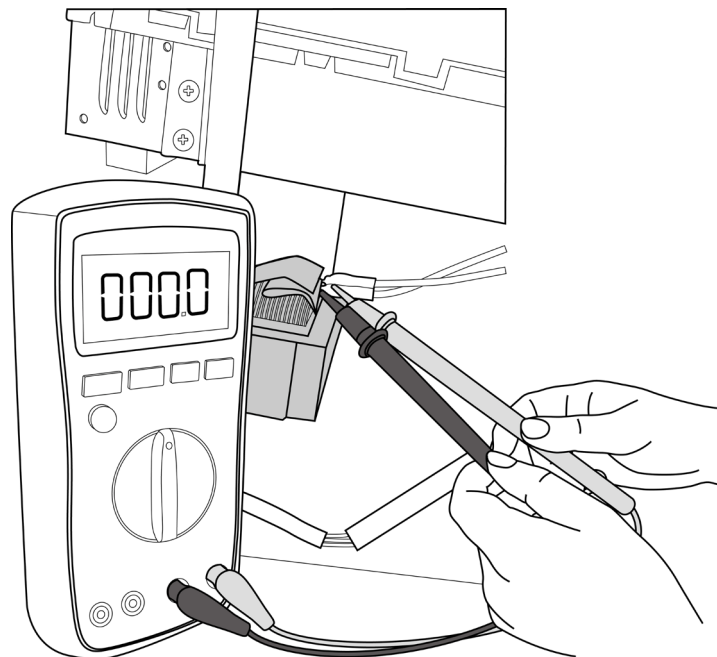

Note: The picture and the value are only for reference, actual condition and specific value may vary.

485 Communication(S1,S2 Communication):

Recommended parts to prepare:

- Signal wires
- Magnet ring
- Indoor PCB
- Outdoor PCB

Troubleshooting and repair:

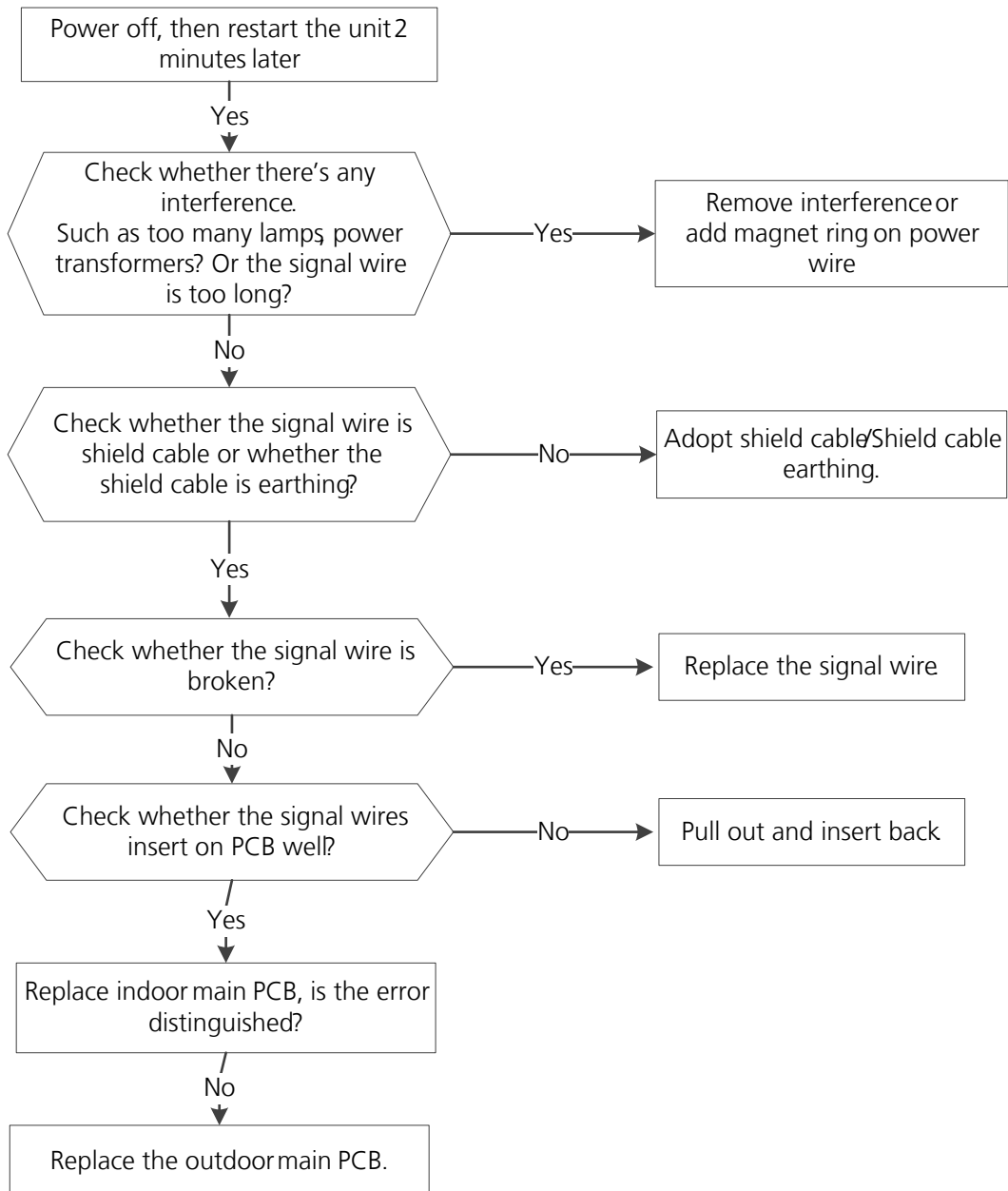

6.3 EH 03 / EC 07 (Fan Speed Is Operating Outside of Normal Range Diagnosis and Solution)

Description: When indoor / outdoor fan speed keeps too low or too high for a certain time, the unit ceases operation and the LED displays the failure.

Recommended parts to prepare:

- Connection wires
- Fan assembly
- Fan motor
- PCB

Troubleshooting and repair:

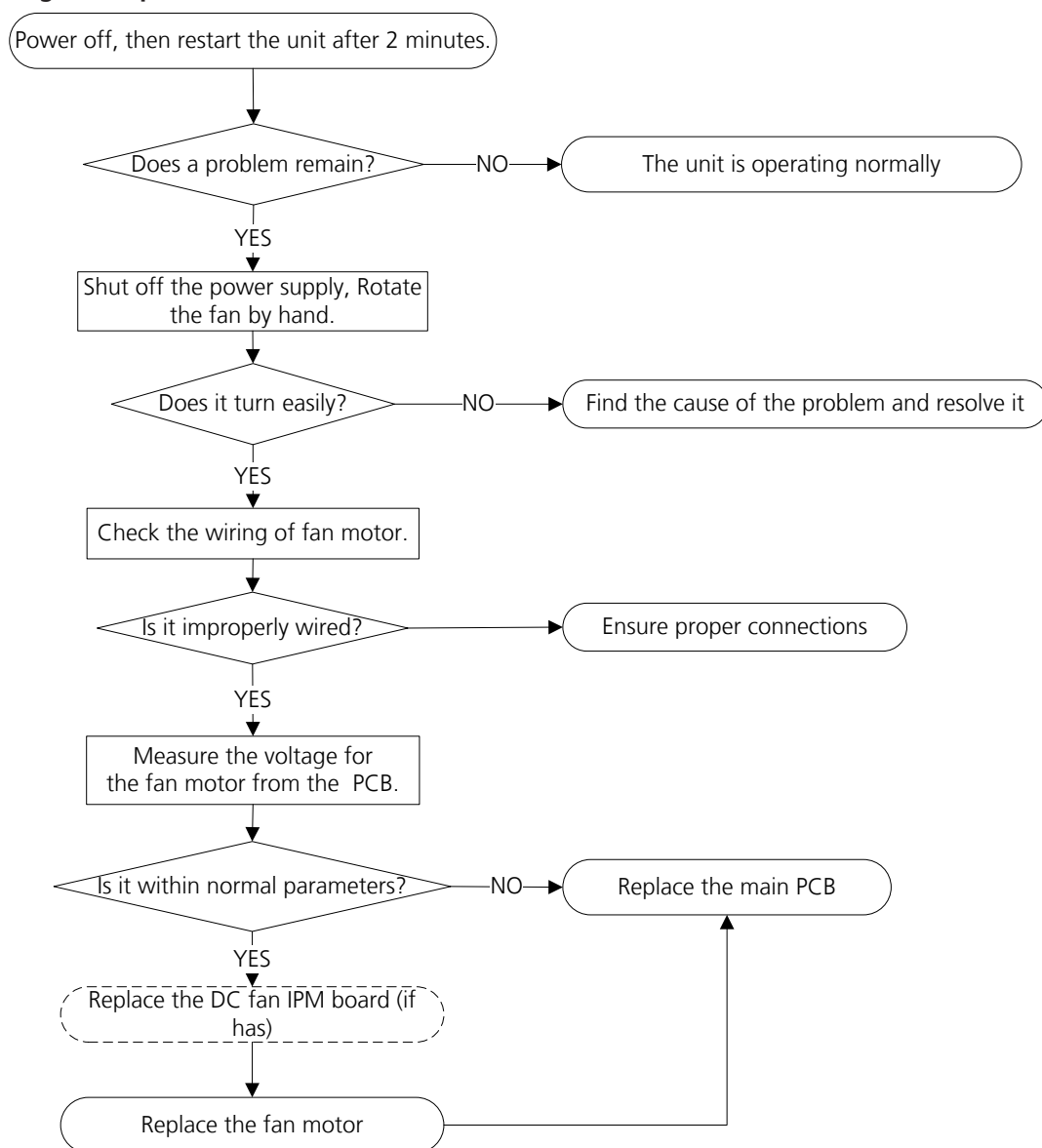

Index:

1. Indoor or Outdoor DC Fan Motor(control chip is in fan motor)

Power on and when the unit is in standby, measure the voltage of pin1-pin3, pin4-pin3 in fan motor connector. If the value of the voltage is not in the range showing in below table, the PCB must has problems and need to be replaced.

No.	Color	Signal	Voltage
1	Red	Vs/Vm	192V~380V
2	---	---	---
3	Black	GND	0V
4	White	Vcc	13.5-16.5V
5	Yellow	Vsp	0~6.5V
6	Blue	FG	13.5-16.5V

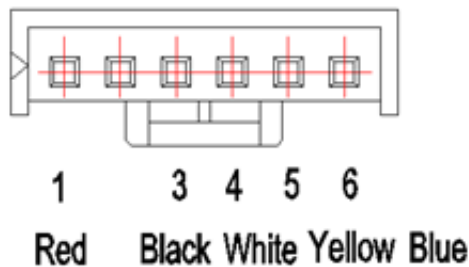

2. Outdoor DC Fan Motor (control chip is in outdoor PCB)

Release the UVW connector. Measure the resistance of U-V, U-W, V-W. If the resistance is not equal to each other, the fan motor must has problems and need to be replaced. otherwise the PCB must has problems and need to be replaced.

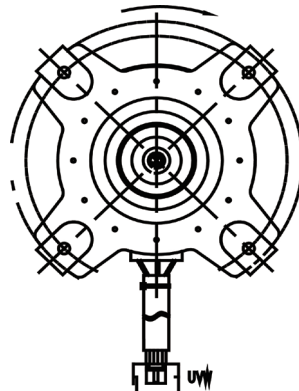

6.4 EH 60/EH 61/EH 62/EH 66/EH 65/EC 53/EC 52/EC 54/EC 56 (Open Circuit or Short Circuit of Temperature Sensor Diagnosis and Solution)

Description: If the sampling voltage is lower than 0.06V or higher than 4.94V, the LED displays the failure.

Recommended parts to prepare:

- Connection wires
- Sensors
- PCB

Troubleshooting and repair:

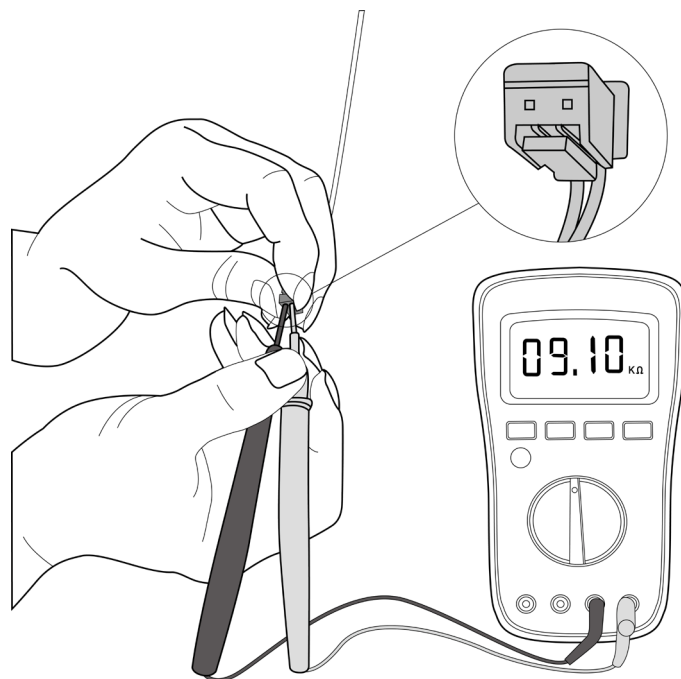
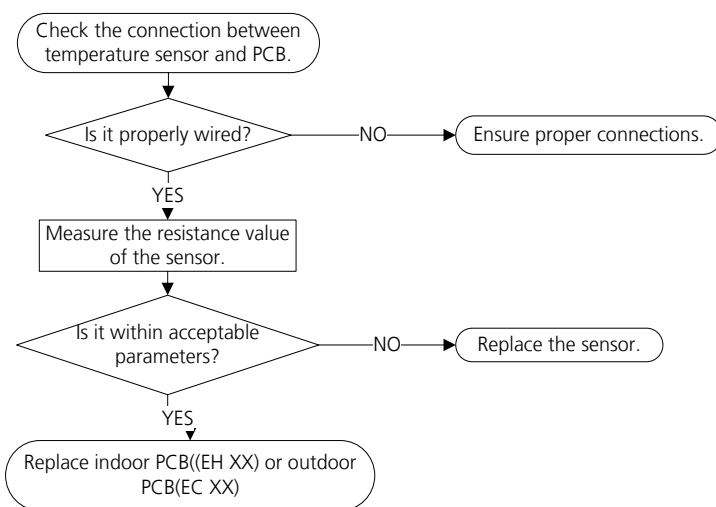

This picture and the value are only for reference, actual appearance and value may vary

6.5 EL 0C (System lacks refrigerant Diagnosis and Solution)

Description: Judging the abnormality of the refrigeration system according to the number of compressor stops and the changes in operating parameters caused by excessive exhaust temperature.

Recommended parts to prepare:

- Indoor PCB
- Additional refrigerant

Troubleshooting and repair:

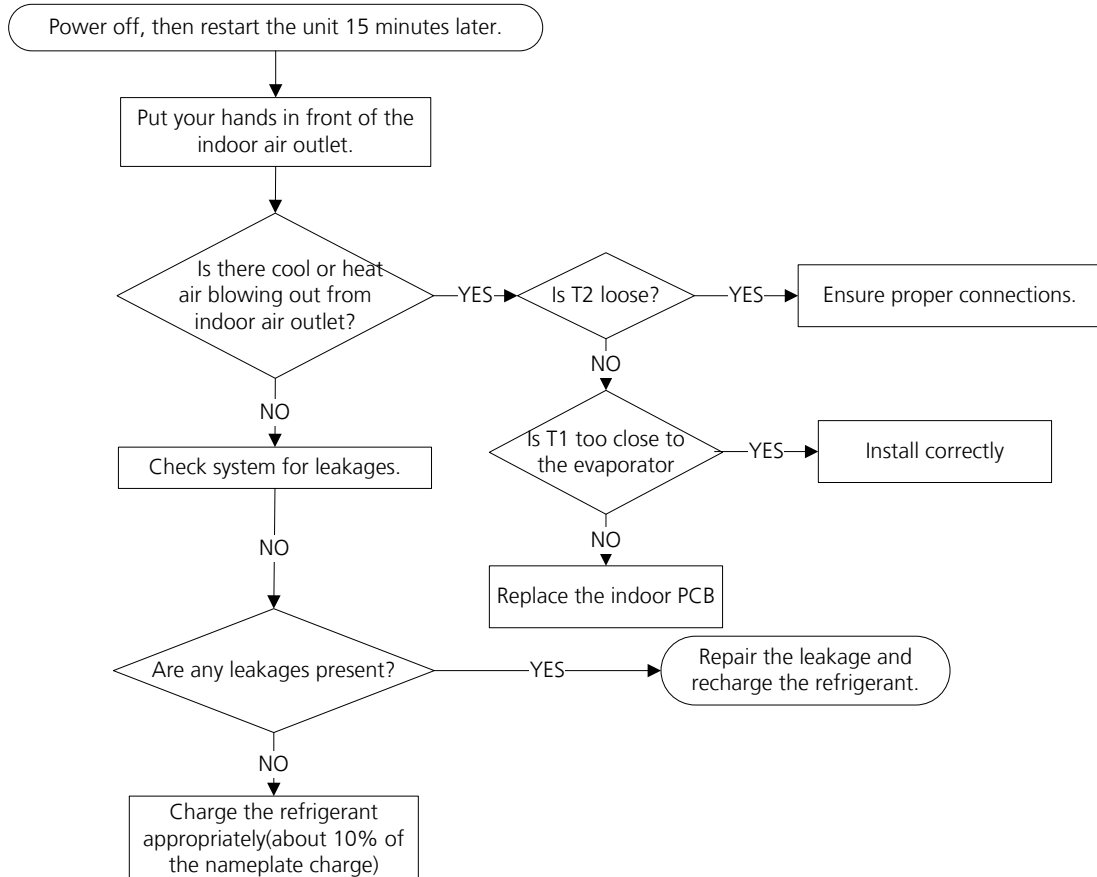

6.6 EH 0E(Water-Level Alarm Malfunction Diagnosis and Solution)

Description: If the sampling voltage is not 5V, the LED displays the failure code.

Recommended parts to prepare:

- Connection wires
- Water-level switch
- Water pump
- Indoor PCB

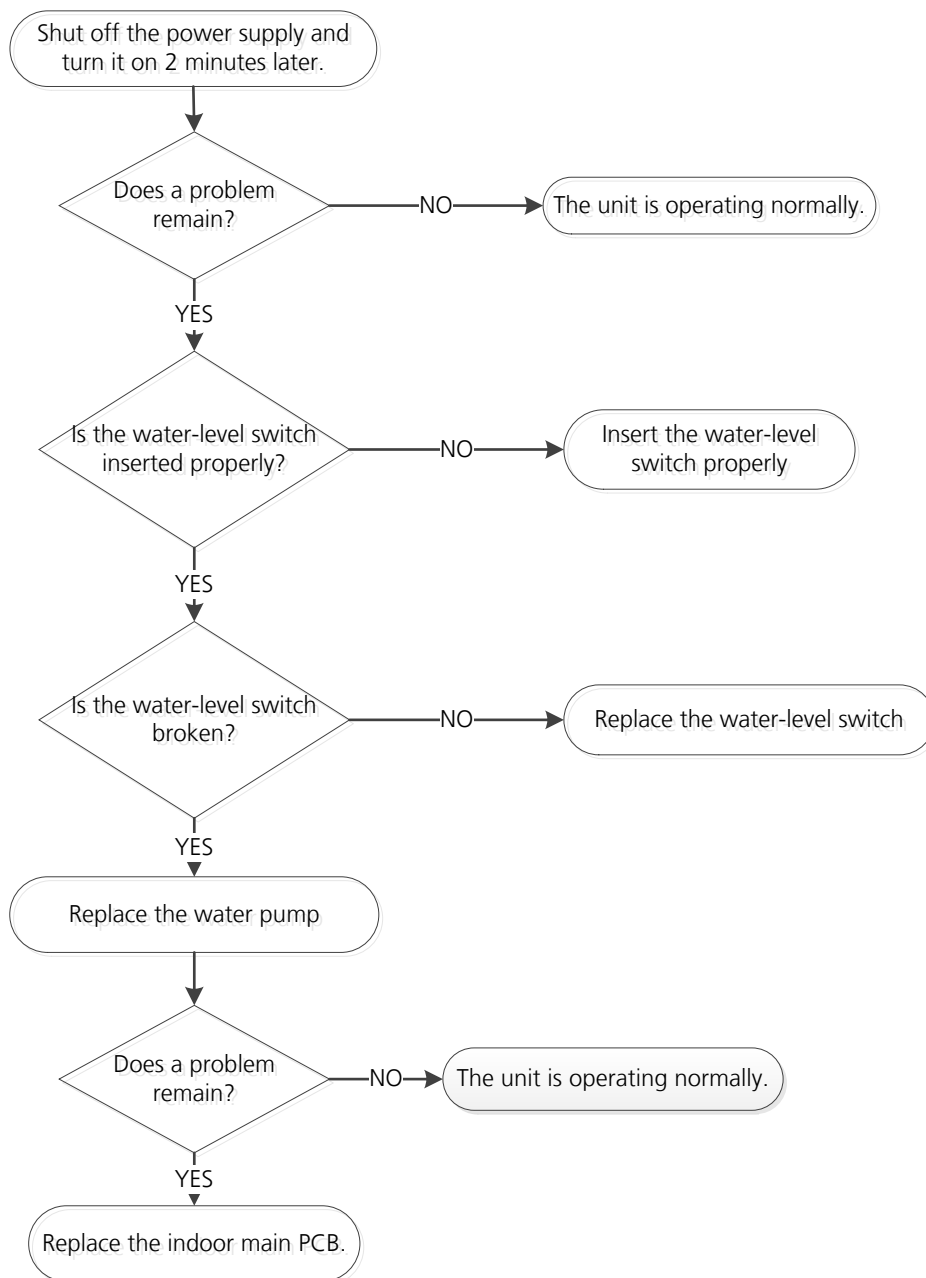

6.7 PC 00(ODU IPM module protection Diagnosis and Solution)

Description: When the voltage signal the IPM sends to the compressor drive chip is abnormal, the display LED shows “PC 00” and the AC turn off.

Recommended parts to prepare:

- Connection wires
- IPM module board
- Outdoor fan assembly
- Compressor
- Outdoor PCB

Troubleshooting and repair:

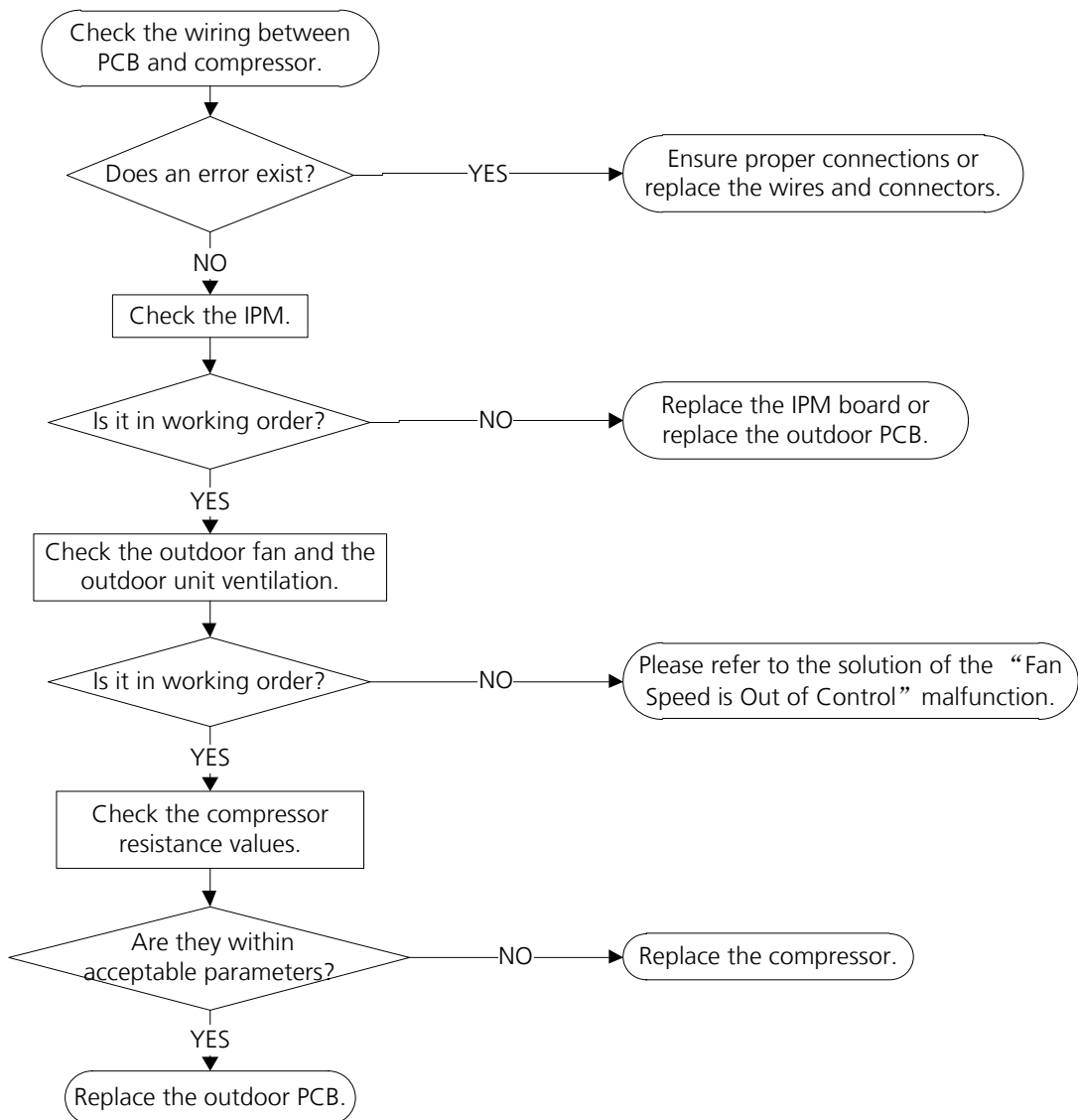

6.8 PC 01(ODU voltage protection Diagnosis and Solution)

Description: Abnormal increases or decreases in voltage are detected by checking the specified voltage detection circuit.

Recommended parts to prepare:

- Power supply wires
- IPM module board
- PCB
- Reactor

Troubleshooting and repair:

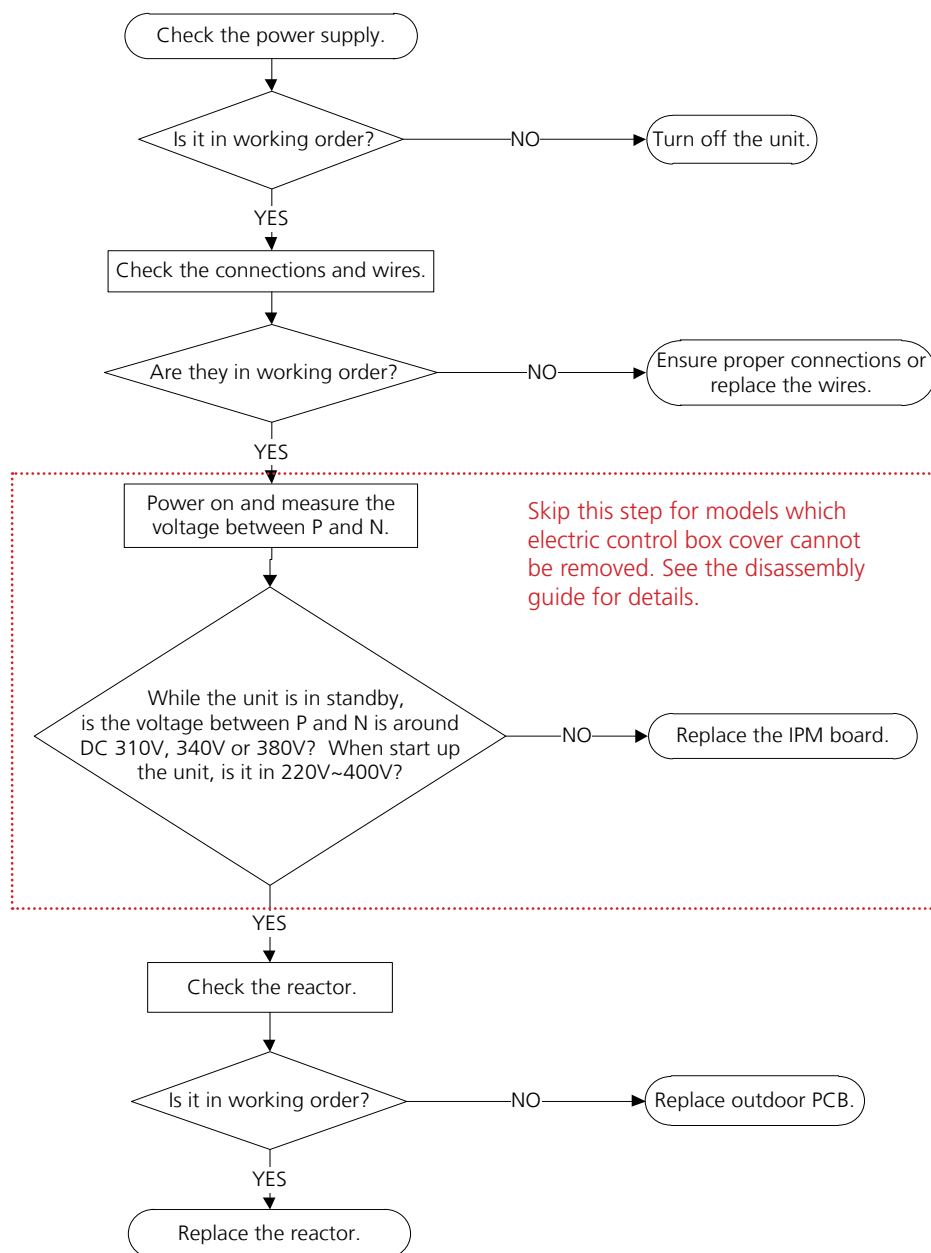

6.9 PC 04(Inverter compressor drive error Diagnosis and Solution)

Description: An abnormal inverter compressor drive is detected by a special detection circuit, including communication signal detection, voltage detection, compressor rotation speed signal detection and so on.

Recommended parts to prepare:

- Connection wires
- IPM module board
- Outdoor fan assembly
- Compressor
- Outdoor PCB

Troubleshooting and repair:

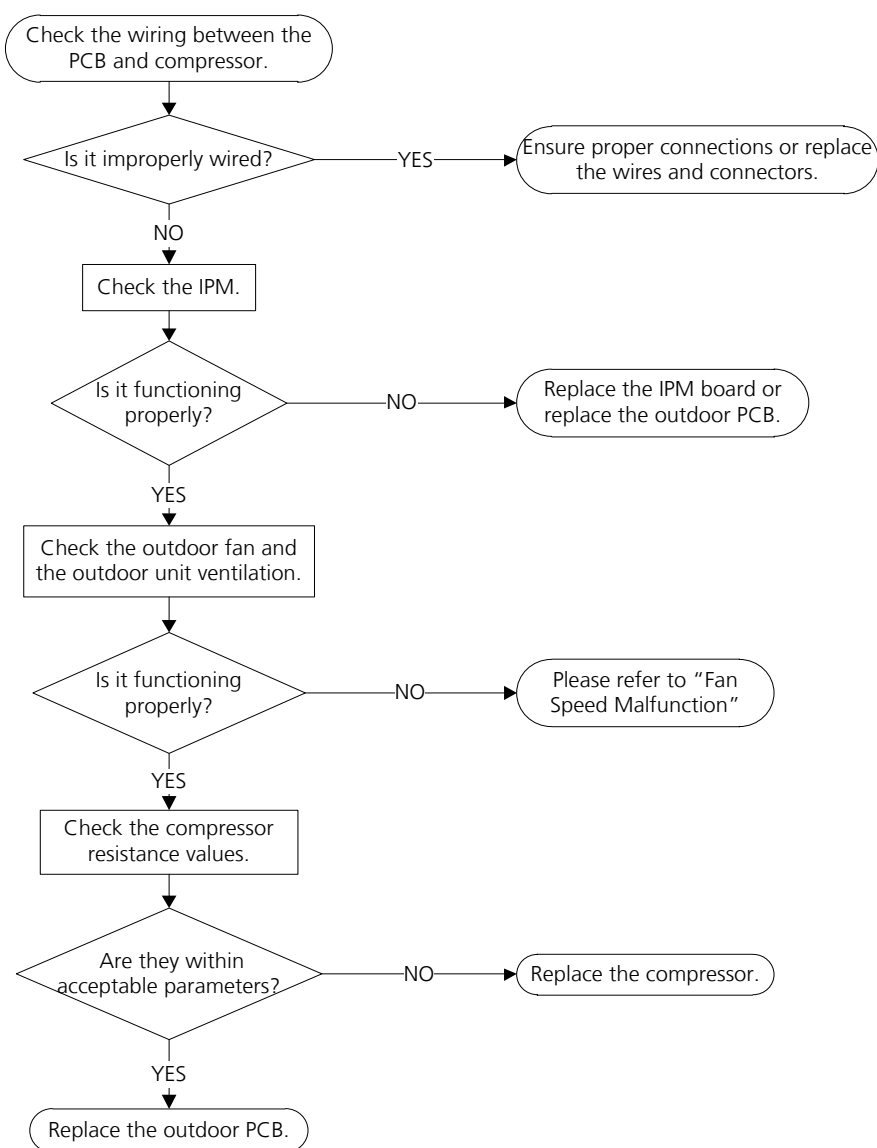

6.10 PC 03(Pressure protection(low or high pressure) Diagnosis and Solution)

Description: Outdoor pressure switch cut off the system because high pressure is higher than 4.4 MPa or outdoor pressure switch cut off the system because low pressure is lower than 0.13 MPa, the LED displays the failure code.

Recommended parts to prepare:

- Connection wires
- Pressure switch
- Outdoor fan
- Outdoor main PCB
- Refrigerant

Troubleshooting and repair:

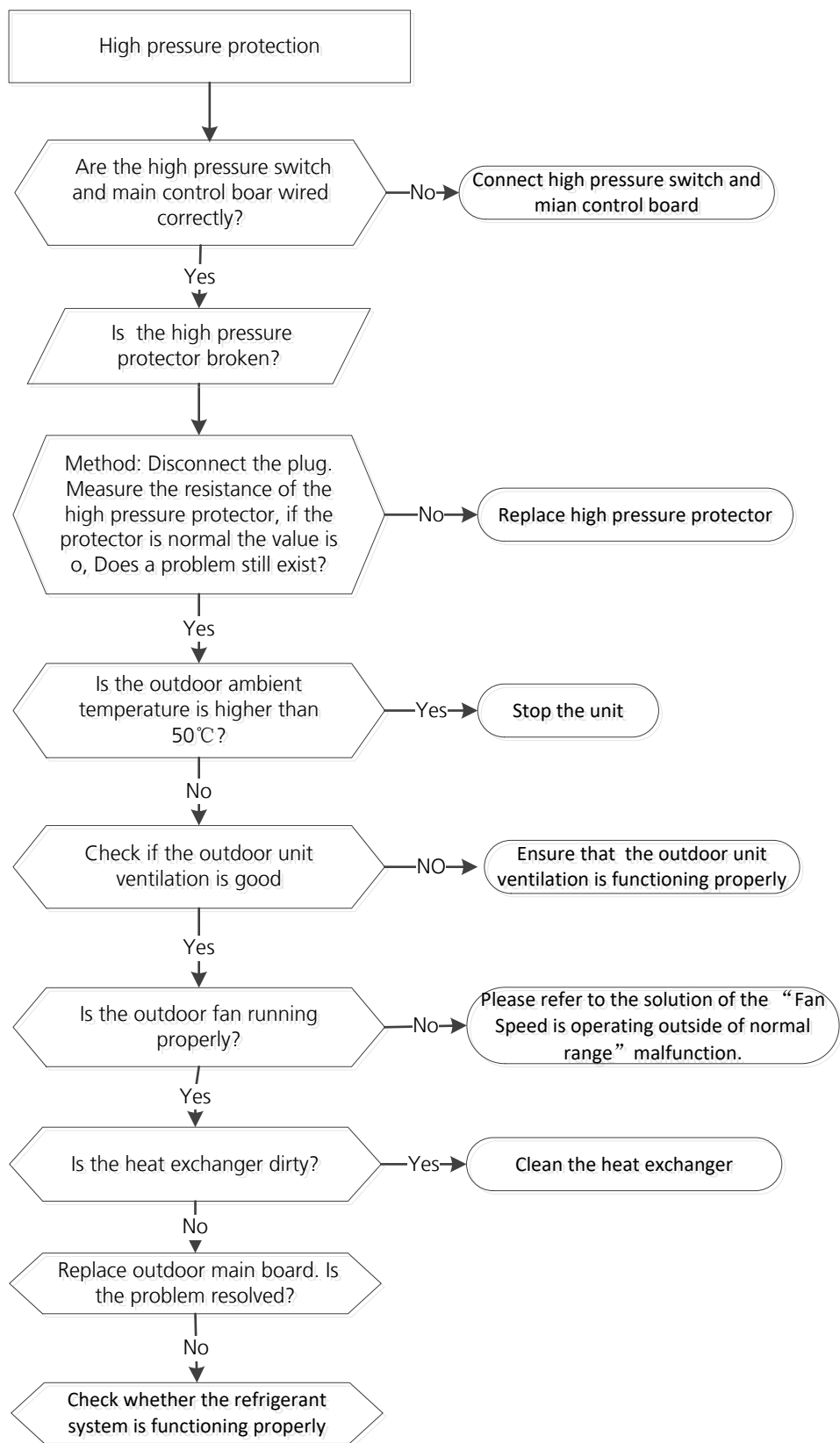

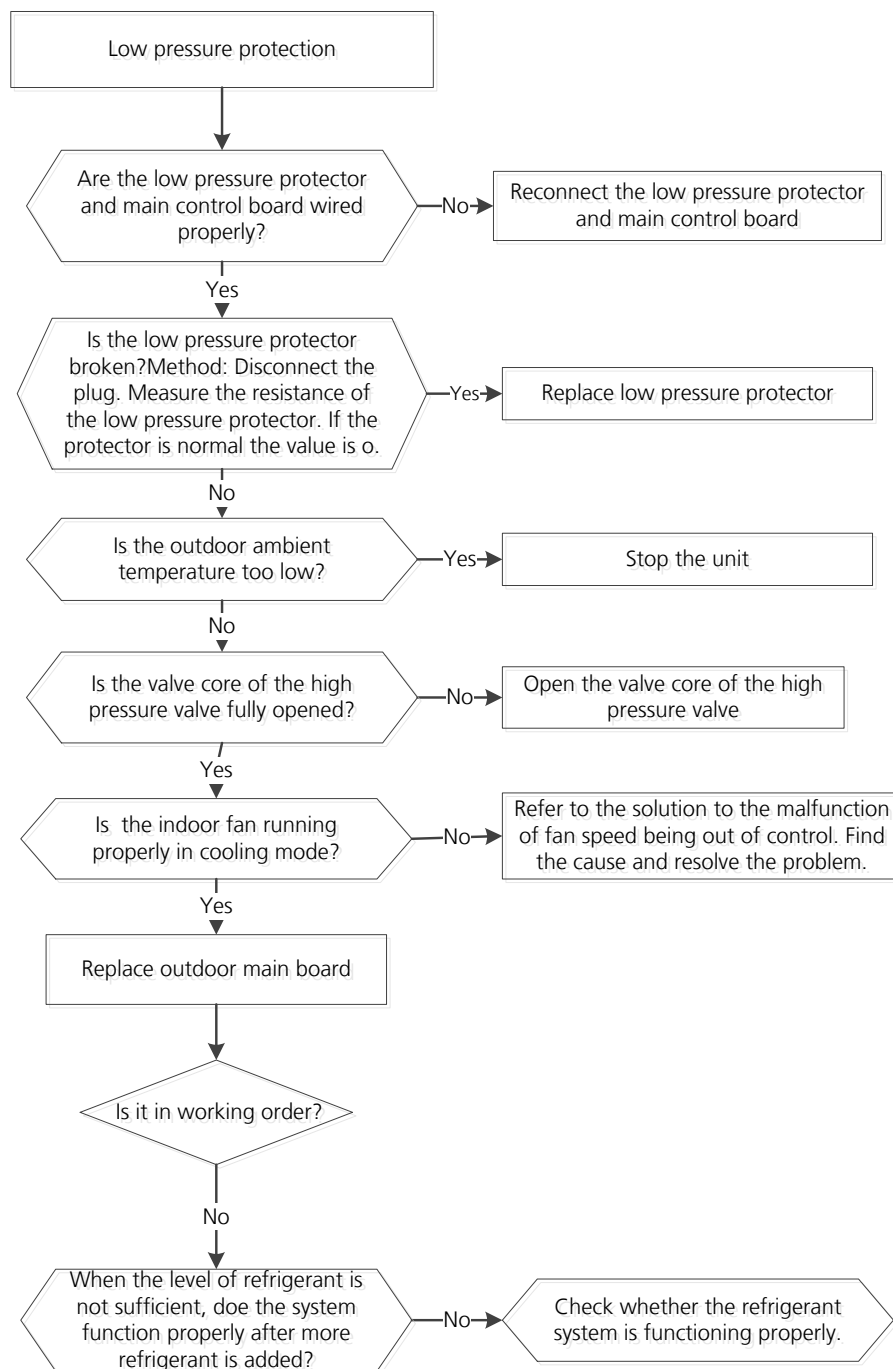

6.11 PC 02(Compressor top (or IPM) temp. protection diagnosis and solution)

Description: For some models with overload protection, If the sampling voltage is not 5V, the LED will display the failure. If the temperature of IPM module is higher than a certain value, the LED displays the failure code.

Recommended parts to prepare:

- Connection wires
- Outdoor PCB
- IPM module board
- High pressure protector
- System blockages

Troubleshooting and repair:

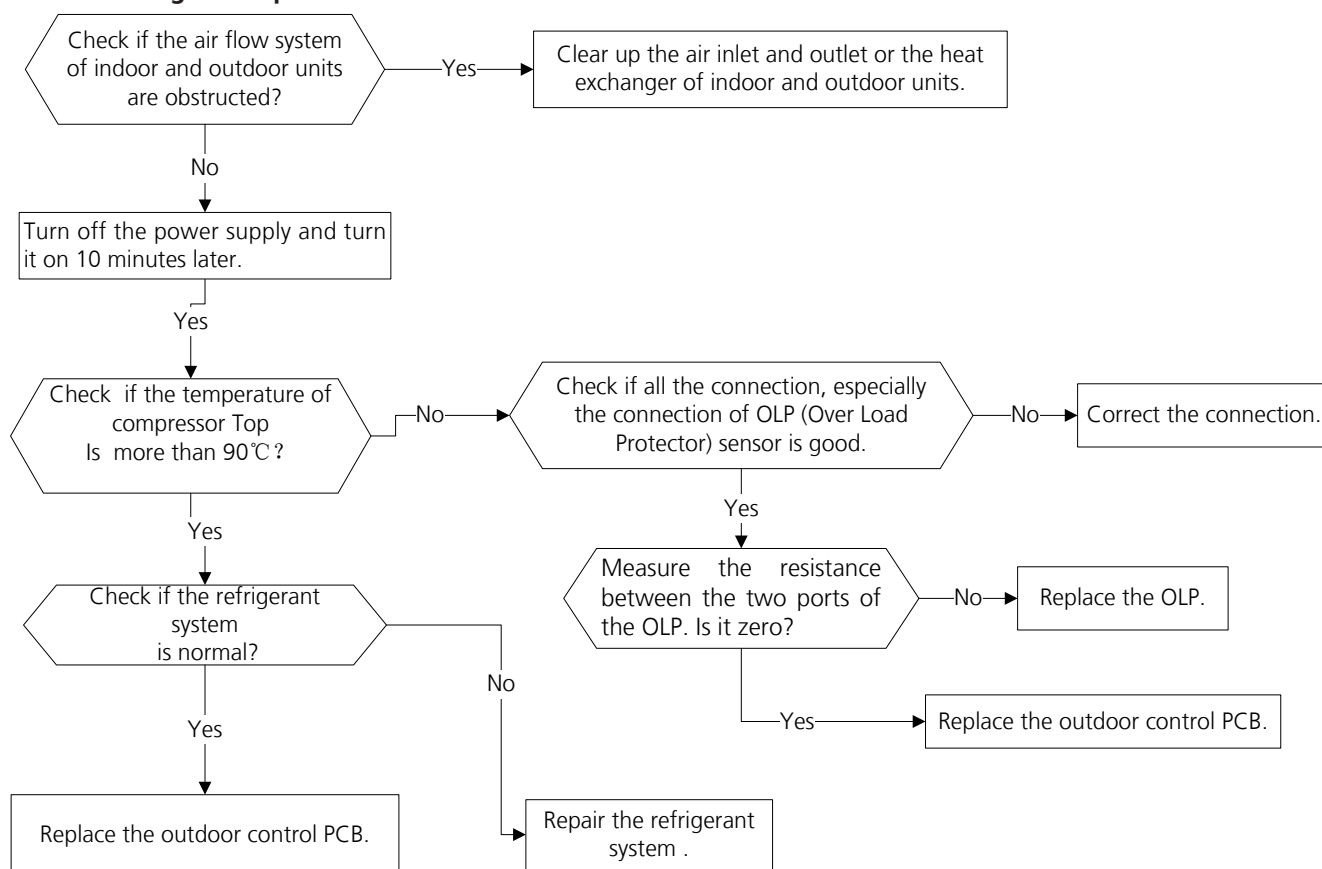

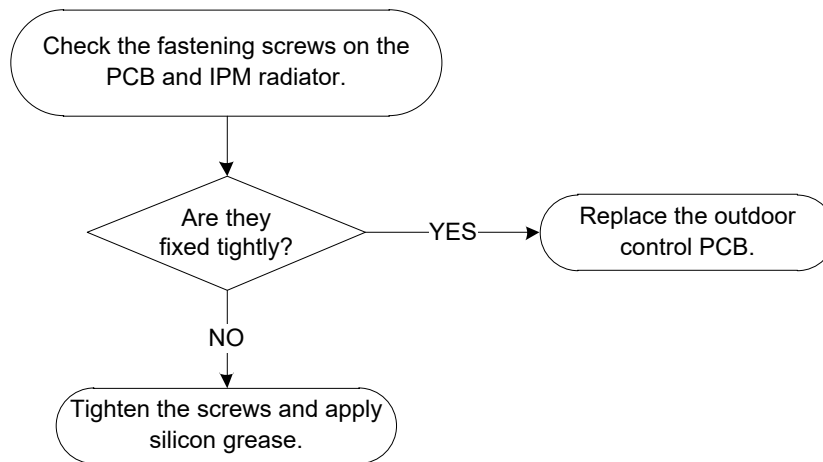

6.12 PC 0L (Low ambient temperature protection)

Description: It is a protection function. When compressor is off, outdoor ambient temperature(T4) is lower than -35°C. for 10s, the AC will stop and display the failure code.

When compressor is on, outdoor ambient temperature(T4) is lower than -40°C. for 10s, the AC will stop and display the failure code.

When outdoor ambient temperature(T4) is no lower than -32°C. for 10s, the unit will exit protection.

6.13 EH b3 (Communication malfunction between wire and master control) Diagnosis and Solution

Description: If Indoor PCB does not receive feedback from wired controller, the error displays on the wired controller

Recommended parts to prepare:

- Connection wires
- Indoor PCB
- Wired controller

Troubleshooting and repair:

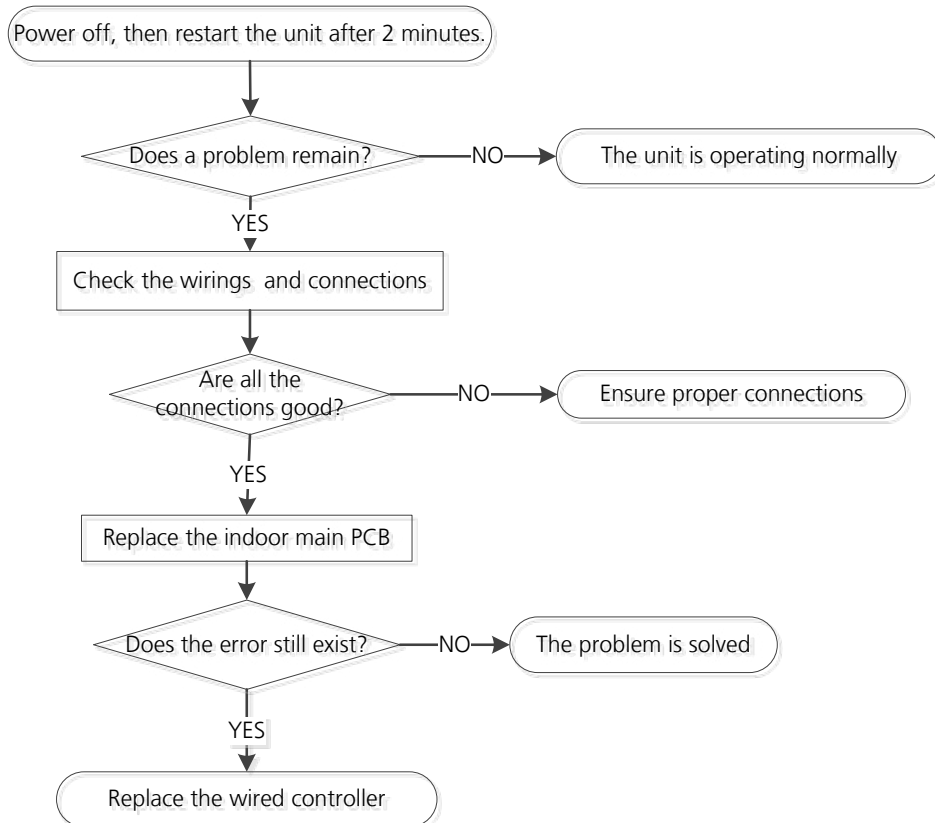

6.14 EH bA(Communication malfunction between indoor unit and external fan module)/ EH 3A(External fan DC bus voltage is too low protection)/ EH 3b(External fan DC bus voltage is too high fault) diagnosis and solution

Description: Indoor unit does not receive the feedback from external fan module during 150 seconds.
or Indoor unit receives abnormal increases or decreases in voltage from external fan module.

Recommended parts to prepare:

- Indoor main PCB

Troubleshooting and repair:

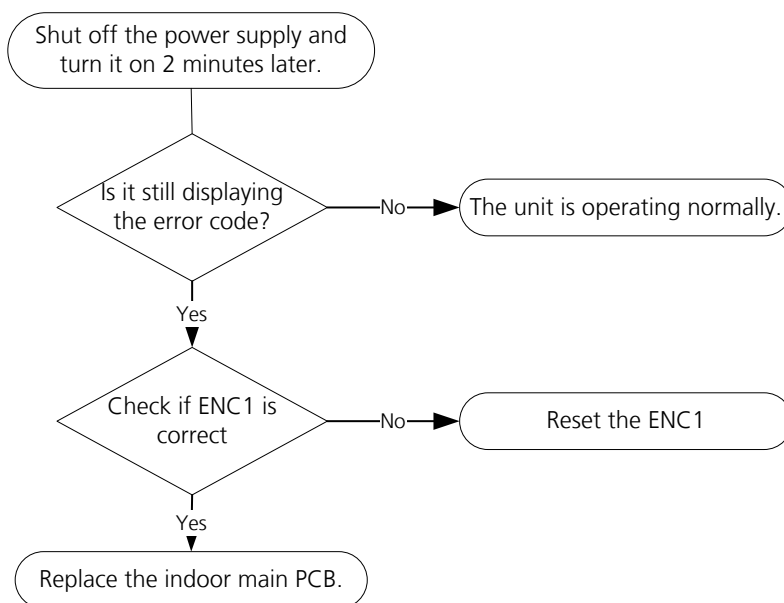

6.15 FH CC(Refrigerant sensor error) or EH C3(Refrigerant sensor is out of range) diagnosis and solution

Description: Indoor unit receives fault signal for 10s or indoor unit does not receive feedback from refrigerant sensor for 150s.

Recommended parts to prepare:

- Connection wires
- Sensors
- Indoor main PCB

Troubleshooting and repair:

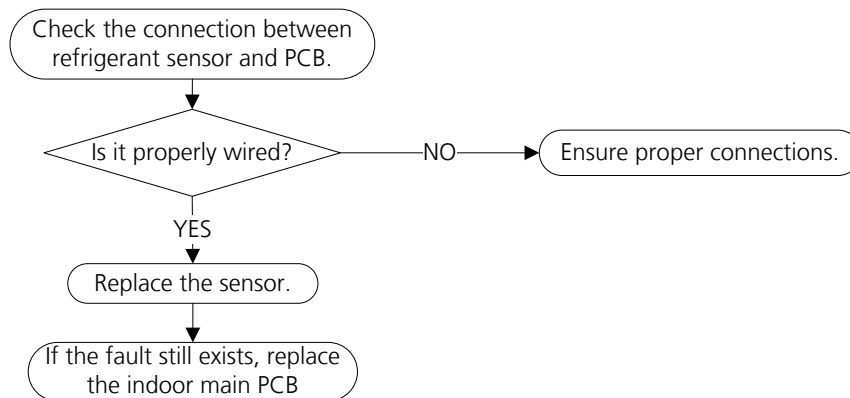

6.16 EH C1(Refrigerant sensor detects leakage) or EH C2(Refrigerant sensor is out of range and leakage is detected) diagnosis and solution

Description:

The refrigerant sensor detects a concentration higher than or equal to 10%*LFL for 10 seconds or the refrigerant sensor detects a concentration higher than or equal to 20%*LFL or the multi model receives the refrigerant leakage protection fault sent by the outdoor unit.

Multi-zone: Only the buzzer of the indoor unit that detects refrigerant leakage continues to sound the alarm, the shortest sound is 10 seconds, and the longest sound is 5 minutes (you can press any key such as remote control or wire control, APP and so on to eliminate the alarm), and the other non-refrigerant leakage fault indoor unit only displays "ECC1", but the buzzer does not sound.

Recommended parts to prepare:

- Additional refrigerant

Troubleshooting and repair:

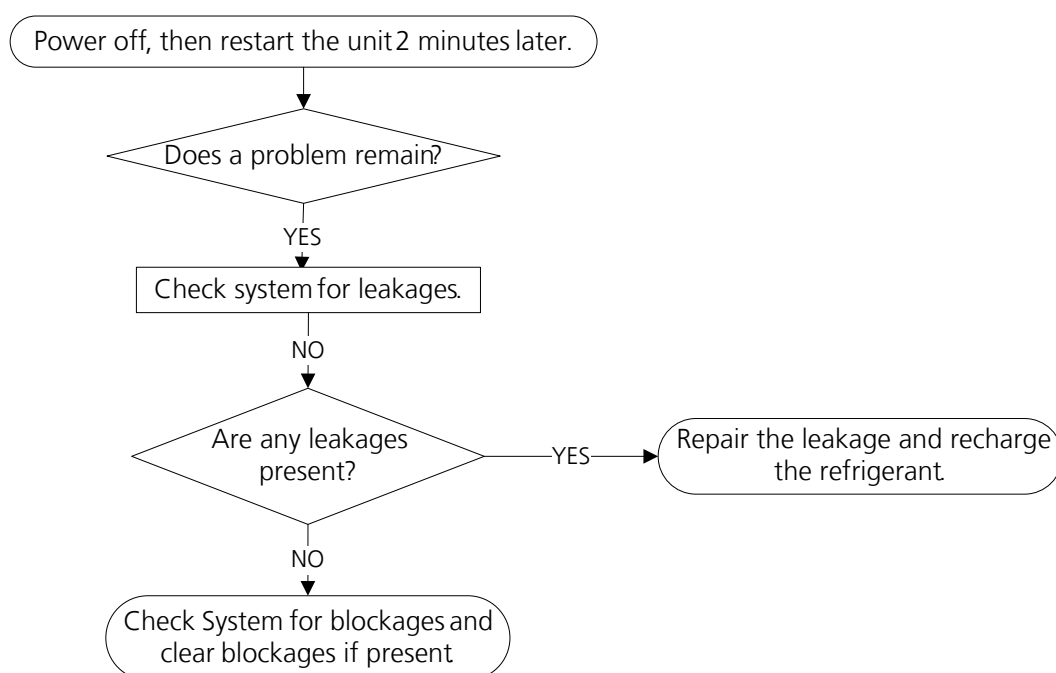

6.17 EC 0d(ODU malfunction Diagnosis and Solution)

Description: The indoor unit detect the outdoor unit is error.

Recommended parts to prepare:

- Outdoor unit

Troubleshooting and repair:

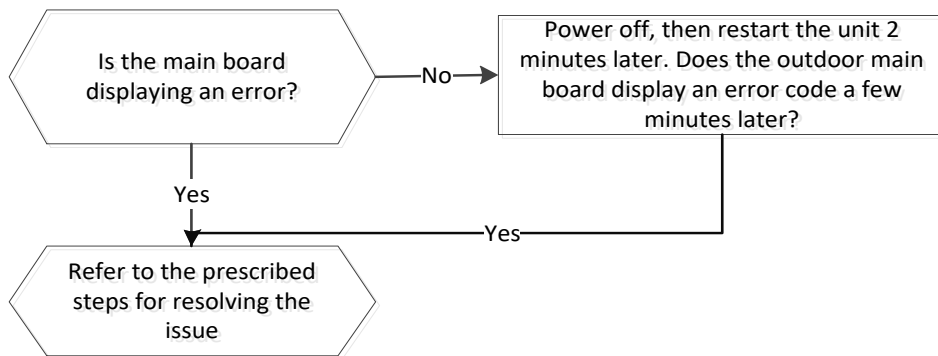

6.18 EH 0b(IDU main control board and display board communication error diagnosis and solution)

Description: Indoor PCB does not receive feedback from the display board.

Recommended parts to prepare:

- Communication wire
- Indoor PCB
- Display board

Troubleshooting and repair:

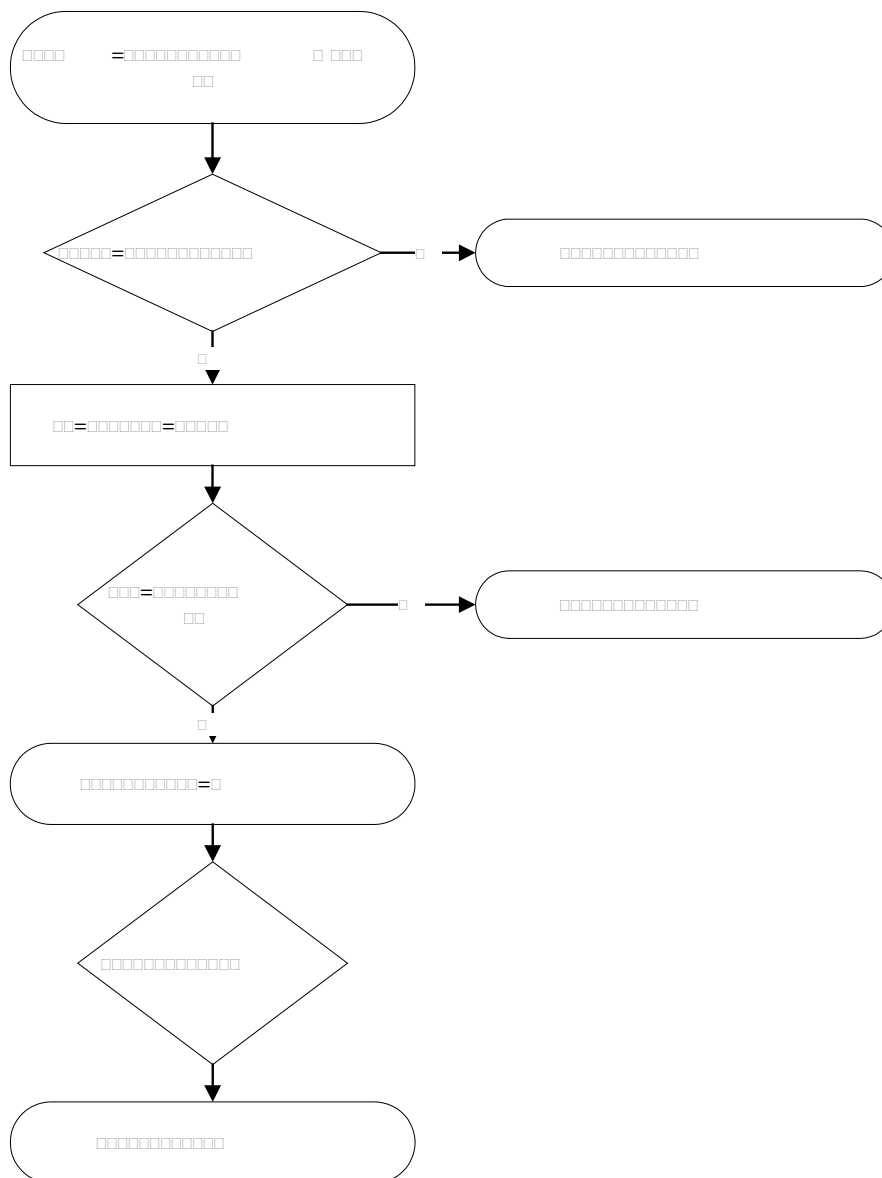

6.19 EL 16(Communication malfunction between adapter board and outdoor main board diagnosis and solution)

Description: The adapter PCB cannot detect the main control board.

Recommended parts to prepare:

- Connection wires
- Adapter board
- Outdoor main PCB

Troubleshooting and repair:

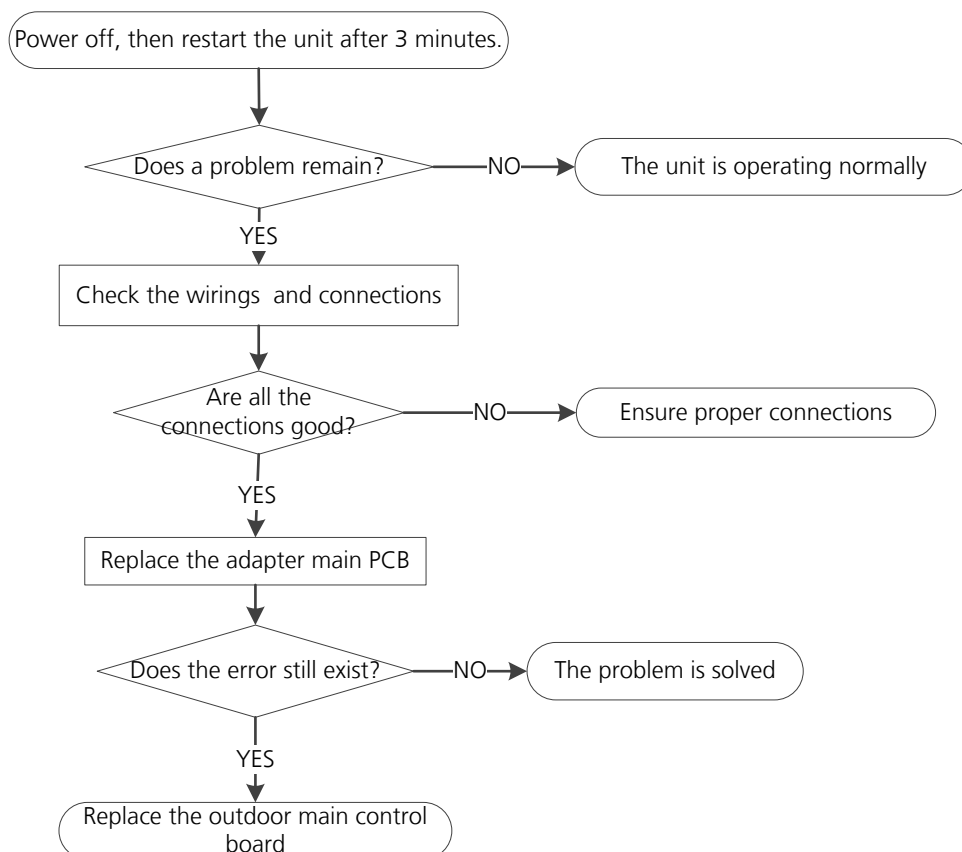

6.20 FL 09(Mismatch between the new and old platforms diagnosis and solution)

Description: Indoor and outdoor units are mismatched, the LED displays this code. Please replace the matching indoor or outdoor unit.

7. Check Procedures

7.1 Temperature Sensor Check

WARNING

Be sure to turn off all power supplies or disconnect all wires to avoid electric shock. Operate after compressor and coil have returned to normal temperature in case of injury.

1. Disconnect temperature sensor from PCB (Refer to Indoor Disassembly and Outdoor Disassembly).
2. Measure the resistance value of the sensor using a multi-meter.
3. Check corresponding temperature sensor resistance value table (Refer to Chapter 8. Appendix).

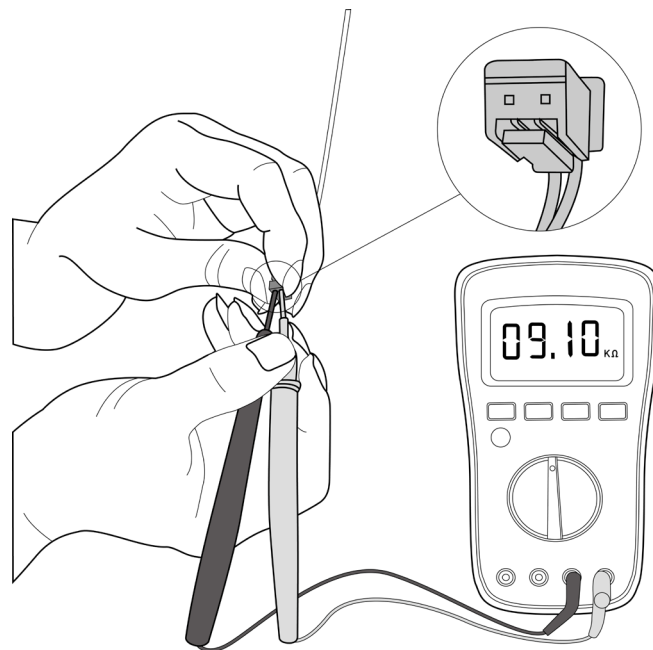

Note: The picture and the value are only for reference, actual condition and specific value may vary.

Appendix

Contents

i)	Temperature Sensor Resistance Value Table for TP (°C --K).....	2
ii)	Other Temperature Sensors Resistance Value Table (°C – K).....	3
iii)	System Pressure Table	4

i) Temperature Sensor Resistance Value Table for TP (°C --K)

°C	°F	K Ohm	°C	°F	K Ohm	°C	°F	K Ohm	°C	°F	K Ohm
°C	°F	K Ohm	°C	°F	K Ohm	°C	°F	K Ohm	°C	°F	K Ohm
-20	-4	542.7	20	68	68.66	60	140	13.59	100	212	3.702
-19	-2	511.9	21	70	65.62	61	142	13.11	101	214	3.595
-18	0	483	22	72	62.73	62	144	12.65	102	216	3.492
-17	1	455.9	23	73	59.98	63	145	12.21	103	217	3.392
-16	3	430.5	24	75	57.37	64	147	11.79	104	219	3.296
-15	5	406.7	25	77	54.89	65	149	11.38	105	221	3.203
-14	7	384.3	26	79	52.53	66	151	10.99	106	223	3.113
-13	9	363.3	27	81	50.28	67	153	10.61	107	225	3.025
-12	10	343.6	28	82	48.14	68	154	10.25	108	226	2.941
-11	12	325.1	29	84	46.11	69	156	9.902	109	228	2.86
-10	14	307.7	30	86	44.17	70	158	9.569	110	230	2.781
-9	16	291.3	31	88	42.33	71	160	9.248	111	232	2.704
-8	18	275.9	32	90	40.57	72	162	8.94	112	234	2.63
-7	19	261.4	33	91	38.89	73	163	8.643	113	235	2.559
-6	21	247.8	34	93	37.3	74	165	8.358	114	237	2.489
-5	23	234.9	35	95	35.78	75	167	8.084	115	239	2.422
-4	25	222.8	36	97	34.32	76	169	7.82	116	241	2.357
-3	27	211.4	37	99	32.94	77	171	7.566	117	243	2.294
-2	28	200.7	38	100	31.62	78	172	7.321	118	244	2.233
-1	30	190.5	39	102	30.36	79	174	7.086	119	246	2.174
0	32	180.9	40	104	29.15	80	176	6.859	120	248	2.117
1	34	171.9	41	106	28	81	178	6.641	121	250	2.061
2	36	163.3	42	108	26.9	82	180	6.43	122	252	2.007
3	37	155.2	43	109	25.86	83	181	6.228	123	253	1.955
4	39	147.6	44	111	24.85	84	183	6.033	124	255	1.905
5	41	140.4	45	113	23.89	85	185	5.844	125	257	1.856
6	43	133.5	46	115	22.89	86	187	5.663	126	259	1.808
7	45	127.1	47	117	22.1	87	189	5.488	127	261	1.762
8	46	121	48	118	21.26	88	190	5.32	128	262	1.717
9	48	115.2	49	120	20.46	89	192	5.157	129	264	1.674
10	50	109.8	50	122	19.69	90	194	5	130	266	1.632
11	52	104.6	51	124	18.96	91	196	4.849			
12	54	99.69	52	126	18.26	92	198	4.703			
13	55	95.05	53	127	17.58	93	199	4.562			
14	57	90.66	54	129	16.94	94	201	4.426			
15	59	86.49	55	131	16.32	95	203	4.294			
16	61	82.54	56	133	15.73	96	205	4.167			
17	63	78.79	57	135	15.16	97	207	4.045			
18	64	75.24	58	136	14.62	98	208	3.927			
19	66	71.86	59	138	14.09	99	210	3.812			







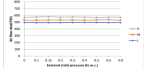
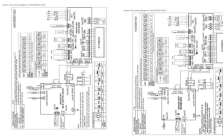

ii) Other Temperature Sensors Resistance Value Table (°C – K)

°C	°F	K Ohm	°C	°F	K Ohm	°C	°F	K Ohm	°C	°F	K Ohm
-20	-4	115.266	20	68	12.6431	60	140	2.35774	100	212	0.62973
-19	-2	108.146	21	70	12.0561	61	142	2.27249	101	214	0.61148
-18	0	101.517	22	72	11.5	62	144	2.19073	102	216	0.59386
-17	1	96.3423	23	73	10.9731	63	145	2.11241	103	217	0.57683
-16	3	89.5865	24	75	10.4736	64	147	2.03732	104	219	0.56038
-15	5	84.219	25	77	10	65	149	1.96532	105	221	0.54448
-14	7	79.311	26	79	9.55074	66	151	1.89627	106	223	0.52912
-13	9	74.536	27	81	9.12445	67	153	1.83003	107	225	0.51426
-12	10	70.1698	28	82	8.71983	68	154	1.76647	108	226	0.49989
-11	12	66.0898	29	84	8.33566	69	156	1.70547	109	228	0.486
-10	14	62.2756	30	86	7.97078	70	158	1.64691	110	230	0.47256
-9	16	58.7079	31	88	7.62411	71	160	1.59068	111	232	0.45957
-8	18	56.3694	32	90	7.29464	72	162	1.53668	112	234	0.44699
-7	19	52.2438	33	91	6.98142	73	163	1.48481	113	235	0.43482
-6	21	49.3161	34	93	6.68355	74	165	1.43498	114	237	0.42304
-5	23	46.5725	35	95	6.40021	75	167	1.38703	115	239	0.41164
-4	25	44	36	97	6.13059	76	169	1.34105	116	241	0.4006
-3	27	41.5878	37	99	5.87359	77	171	1.29078	117	243	0.38991
-2	28	39.8239	38	100	5.62961	78	172	1.25423	118	244	0.37956
-1	30	37.1988	39	102	5.39689	79	174	1.2133	119	246	0.36954
0	32	35.2024	40	104	5.17519	80	176	1.17393	120	248	0.35982
1	34	33.3269	41	106	4.96392	81	178	1.13604	121	250	0.35042
2	36	31.5635	42	108	4.76253	82	180	1.09958	122	252	0.3413
3	37	29.9058	43	109	4.5705	83	181	1.06448	123	253	0.33246
4	39	28.3459	44	111	4.38736	84	183	1.03069	124	255	0.3239
5	41	26.8778	45	113	4.21263	85	185	0.99815	125	257	0.31559
6	43	25.4954	46	115	4.04589	86	187	0.96681	126	259	0.30754
7	45	24.1932	47	117	3.88673	87	189	0.93662	127	261	0.29974
8	46	22.5662	48	118	3.73476	88	190	0.90753	128	262	0.29216
9	48	21.8094	49	120	3.58962	89	192	0.8795	129	264	0.28482
10	50	20.7184	50	122	3.45097	90	194	0.85248	130	266	0.2777
11	52	19.6891	51	124	3.31847	91	196	0.82643	131	268	0.27078
12	54	18.7177	52	126	3.19183	92	198	0.80132	132	270	0.26408
13	55	17.8005	53	127	3.07075	93	199	0.77709	133	271	0.25757
14	57	16.9341	54	129	2.95896	94	201	0.75373	134	273	0.25125
15	59	16.1156	55	131	2.84421	95	203	0.73119	135	275	0.24512
16	61	15.3418	56	133	2.73823	96	205	0.70944	136	277	0.23916
17	63	14.6181	57	135	2.63682	97	207	0.68844	137	279	0.23338
18	64	13.918	58	136	2.53973	98	208	0.66818	138	280	0.22776
19	66	13.2631	59	138	2.44677	99	210	0.64862	139	282	0.22231

iii) System Pressure Table-R454B

Pressure			Temperature		Pressure			Temperature	
Kpa	bar	PSI	°C	°F	Kpa	bar	PSI	°C	°F
58.196	0.58	8.44	-60	-76	935.23	9.35	135.64	8	46.4
61.517	0.62	8.92	-59	-74.2	963.75	9.64	139.78	9	48.2
64.988	0.65	9.43	-58	-72.4	992.93	9.93	144.01	10	50
68.615	0.69	9.95	-57	-70.6	1022.8	10.23	148.34	11	51.8
72.402	0.72	10.50	-56	-68.8	1053.3	10.53	152.76	12	53.6
76.354	0.76	11.07	-55	-67	1084.5	10.85	157.29	13	55.4
80.478	0.80	11.67	-54	-65.2	1116.4	11.16	161.91	14	57.2
84.776	0.85	12.30	-53	-63.4	1149	11.49	166.64	15	59
89.256	0.89	12.95	-52	-61.6	1182.3	11.82	171.47	16	60.8
93.923	0.94	13.62	-51	-59.8	1216.3	12.16	176.40	17	62.6
98.781	0.99	14.33	-50	-58	1251.1	12.51	181.45	18	64.4
103.84	1.04	15.06	-49	-56.2	1286.6	12.87	186.60	19	66.2
109.1	1.09	15.82	-48	-54.4	1322.8	13.23	191.85	20	68
114.56	1.15	16.61	-47	-52.6	1359.9	13.60	197.23	21	69.8
120.25	1.20	17.44	-46	-50.8	1397.7	13.98	202.71	22	71.6
126.15	1.26	18.30	-45	-49	1436.3	14.36	208.31	23	73.4
132.28	1.32	19.18	-44	-47.2	1475.7	14.76	214.02	24	75.2
138.64	1.39	20.11	-43	-45.4	1515.9	15.16	219.85	25	77
145.24	1.45	21.06	-42	-43.6	1557	15.57	225.82	26	78.8
152.09	1.52	22.06	-41	-41.8	1598.9	15.99	231.89	27	80.6
159.18	1.59	23.09	-40	-40	1641.6	16.42	238.09	28	82.4
166.54	1.67	24.15	-39	-38.2	1685.2	16.85	244.41	29	84.2
174.15	1.74	25.26	-38	-36.4	1729.7	17.30	250.86	30	86
182.04	1.82	26.40	-37	-34.6	1775	17.75	257.43	31	87.8
190.2	1.90	27.59	-36	-32.8	1821.3	18.21	264.15	32	89.6
198.65	1.99	28.81	-35	-31	1868.4	18.68	270.98	33	91.4
207.39	2.07	30.08	-34	-29.2	1916.5	19.17	277.95	34	93.2
216.42	2.16	31.39	-33	-27.4	1965.6	19.66	285.08	35	95
225.76	2.26	32.74	-32	-25.6	2015.5	20.16	292.31	36	96.8
235.41	2.35	34.14	-31	-23.8	2066.5	20.67	299.71	37	98.6
245.37	2.45	35.59	-30	-22	2118.4	21.18	307.24	38	100.4
255.67	2.56	37.08	-29	-20.2	2171.3	21.71	314.91	39	102.2
266.29	2.66	38.62	-28	-18.4	2225.2	22.25	322.73	40	104
277.25	2.77	40.21	-27	-16.6	2280.2	22.80	330.70	41	105.8
288.56	2.89	41.85	-26	-14.8	2336.1	23.36	338.81	42	107.6
300.22	3.00	43.54	-25	-13	2393.2	23.93	347.09	43	109.4
312.24	3.12	45.28	-24	-11.2	2451.3	24.51	355.52	44	111.2
324.63	3.25	47.08	-23	-9.4	2510.4	25.10	364.09	45	113
337.39	3.37	48.93	-22	-7.6	2570.7	25.71	372.84	46	114.8
350.54	3.51	50.84	-21	-5.8	2632.1	26.32	381.74	47	116.6
364.08	3.64	52.80	-20	-4	2694.7	26.95	390.82	48	118.4
378.02	3.78	54.83	-19	-2.2	2758.3	27.58	400.04	49	120.2
392.37	3.92	56.91	-18	-0.4	2823.2	28.23	409.46	50	122
407.13	4.07	59.05	-17	1.4	2889.3	28.89	419.04	51	123.8

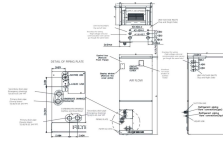
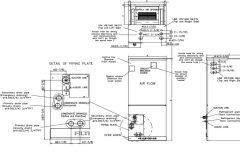
422.31	4.22	61.25	-16	3.2	2956.5	29.57	428.79	52	125.6
437.92	4.38	63.51	-15	5	3025	30.25	438.72	53	127.4
453.98	4.54	65.84	-14	6.8	3094.7	30.95	448.83	54	129.2
470.47	4.70	68.23	-13	8.6	3165.7	31.66	459.13	55	131
487.43	4.87	70.69	-12	10.4	3238.1	32.38	469.63	56	132.8
504.84	5.05	73.22	-11	12.2	3311.7	33.12	480.30	57	134.6
522.73	5.23	75.81	-10	14	3386.7	33.87	491.18	58	136.4
541.1	5.41	78.48	-9	15.8	3463	34.63	502.25	59	138.2
559.95	5.60	81.21	-8	17.6	3540.7	35.41	513.52	60	140
579.31	5.79	84.02	-7	19.4	3619.9	36.20	525.00	61	141.8
599.16	5.99	86.90	-6	21.2	3700.5	37.01	536.69	62	143.6
619.54	6.20	89.85	-5	23	3782.7	37.83	548.61	63	145.4
640.43	6.40	92.88	-4	24.8	3866.3	38.66	560.74	64	147.2
661.86	6.62	95.99	-3	26.6	3951.5	39.52	573.10	65	149
683.82	6.84	99.18	-2	28.4	4038.3	40.38	585.69	66	150.8
706.34	7.06	102.44	-1	30.2	4126.8	41.27	598.52	67	152.6
729.41	7.29	105.79	0	32	4217	42.17	611.60	68	154.4
753.06	7.53	109.22	1	33.8	4309	43.09	624.95	69	156.2
777.28	7.77	112.73	2	35.6	4402.9	44.03	638.56	70	158
802.08	8.02	116.33	3	37.4	4498.7	44.99	652.46	71	159.8
827.48	8.27	120.01	4	39.2	4596.5	45.97	666.64	72	161.6
853.49	8.53	123.78	5	41	4696.5	46.97	681.15	73	163.4
880.11	8.80	127.64	6	42.8	4798.9	47.99	696.00	74	165.2
907.35	9.07	131.60	7	44.6	4904.1	49.04	711.25	75	167

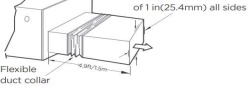
No.	Before	After	Page No.	Note	Date																																																												
1			Page 19-28	Update Fan Performance of 18k-60k(Horizontal scale alignment)	2024.5.31																																																												
2			Page 35-36	Update wiring diagram	2024.5.31																																																												
3	<table border="1" data-bbox="231 448 359 526"> <thead> <tr> <th>Dial code selection</th> <th>Website address</th> </tr> </thead> <tbody> <tr> <td>25</td> <td>5995-05</td> </tr> <tr> <td>26</td> <td>5995-12</td> </tr> <tr> <td>27</td> <td>5995-16</td> </tr> <tr> <td>28</td> <td>5995</td> </tr> </tbody> </table>	Dial code selection	Website address	25	5995-05	26	5995-12	27	5995-16	28	5995	<table border="1" data-bbox="502 448 638 526"> <thead> <tr> <th>Dial code selection</th> <th>Net address</th> </tr> </thead> <tbody> <tr> <td>25</td> <td>1928-05</td> </tr> <tr> <td>26</td> <td>1928-12</td> </tr> <tr> <td>27</td> <td>1928-16</td> </tr> <tr> <td>28</td> <td>1928</td> </tr> </tbody> </table>	Dial code selection	Net address	25	1928-05	26	1928-12	27	1928-16	28	1928	Page 39	Change Website address to Net address	2024.5.31																																								
Dial code selection	Website address																																																																
25	5995-05																																																																
26	5995-12																																																																
27	5995-16																																																																
28	5995																																																																
Dial code selection	Net address																																																																
25	1928-05																																																																
26	1928-12																																																																
27	1928-16																																																																
28	1928																																																																
4	<p>4. Refrigerant Pipe Installation</p> <p>4.1 Recommended copper pipe thickness</p> <table border="1" data-bbox="231 571 335 638"> <thead> <tr> <th>Tube diameter</th> <th>Minimum thickness</th> </tr> </thead> <tbody> <tr> <td>1/2"</td> <td>0.0315</td> </tr> <tr> <td>3/8"</td> <td>0.0248</td> </tr> <tr> <td>1/4"</td> <td>0.0191</td> </tr> <tr> <td>3/16"</td> <td>0.0154</td> </tr> <tr> <td>1/8"</td> <td>0.0118</td> </tr> </tbody> </table> <p>4.2 Maximum length and drop height</p> <table border="1" data-bbox="231 638 335 683"> <thead> <tr> <th>Tube diameter</th> <th>Max. length</th> <th>Max. drop height</th> </tr> </thead> <tbody> <tr> <td>1/2"</td> <td>2000</td> <td>2000</td> </tr> <tr> <td>3/8"</td> <td>1500</td> <td>1500</td> </tr> <tr> <td>1/4"</td> <td>1000</td> <td>1000</td> </tr> <tr> <td>3/16"</td> <td>750</td> <td>750</td> </tr> <tr> <td>1/8"</td> <td>500</td> <td>500</td> </tr> </tbody> </table>	Tube diameter	Minimum thickness	1/2"	0.0315	3/8"	0.0248	1/4"	0.0191	3/16"	0.0154	1/8"	0.0118	Tube diameter	Max. length	Max. drop height	1/2"	2000	2000	3/8"	1500	1500	1/4"	1000	1000	3/16"	750	750	1/8"	500	500	<p>4. Refrigerant Pipe Installation</p> <p>4.1 Recommended copper pipe thickness</p> <table border="1" data-bbox="518 571 622 638"> <thead> <tr> <th>Tube diameter</th> <th>Minimum thickness</th> </tr> </thead> <tbody> <tr> <td>1/2"</td> <td>0.0315</td> </tr> <tr> <td>3/8"</td> <td>0.0248</td> </tr> <tr> <td>1/4"</td> <td>0.0191</td> </tr> <tr> <td>3/16"</td> <td>0.0154</td> </tr> <tr> <td>1/8"</td> <td>0.0118</td> </tr> </tbody> </table> <p>4.2 Maximum length and drop height</p> <table border="1" data-bbox="518 638 622 683"> <thead> <tr> <th>Tube diameter</th> <th>Max. length</th> <th>Max. drop height</th> </tr> </thead> <tbody> <tr> <td>1/2"</td> <td>246</td> <td>246</td> </tr> <tr> <td>3/8"</td> <td>184</td> <td>184</td> </tr> <tr> <td>1/4"</td> <td>133</td> <td>133</td> </tr> <tr> <td>3/16"</td> <td>100</td> <td>100</td> </tr> <tr> <td>1/8"</td> <td>67</td> <td>67</td> </tr> </tbody> </table>	Tube diameter	Minimum thickness	1/2"	0.0315	3/8"	0.0248	1/4"	0.0191	3/16"	0.0154	1/8"	0.0118	Tube diameter	Max. length	Max. drop height	1/2"	246	246	3/8"	184	184	1/4"	133	133	3/16"	100	100	1/8"	67	67	Page 50	1. Change 65/213.3 to 246/75 2. Delete 7/8" (22)	2024.5.31
Tube diameter	Minimum thickness																																																																
1/2"	0.0315																																																																
3/8"	0.0248																																																																
1/4"	0.0191																																																																
3/16"	0.0154																																																																
1/8"	0.0118																																																																
Tube diameter	Max. length	Max. drop height																																																															
1/2"	2000	2000																																																															
3/8"	1500	1500																																																															
1/4"	1000	1000																																																															
3/16"	750	750																																																															
1/8"	500	500																																																															
Tube diameter	Minimum thickness																																																																
1/2"	0.0315																																																																
3/8"	0.0248																																																																
1/4"	0.0191																																																																
3/16"	0.0154																																																																
1/8"	0.0118																																																																
Tube diameter	Max. length	Max. drop height																																																															
1/2"	246	246																																																															
3/8"	184	184																																																															
1/4"	133	133																																																															
3/16"	100	100																																																															
1/8"	67	67																																																															
5			Page 51	Delete 7/8" (22)	2024.5.31																																																												
6	<p>Table: Minimum Cross-Sectional Area of Power and Signal Cables</p> <table border="1" data-bbox="207 996 359 1064"> <thead> <tr> <th>Rated Current of Appliance (A)</th> <th>AWG</th> </tr> </thead> <tbody> <tr> <td>1-5</td> <td>18</td> </tr> <tr> <td>6-10</td> <td>16</td> </tr> <tr> <td>11-15</td> <td>14</td> </tr> <tr> <td>16-25</td> <td>12</td> </tr> <tr> <td>26-32</td> <td>10</td> </tr> </tbody> </table>	Rated Current of Appliance (A)	AWG	1-5	18	6-10	16	11-15	14	16-25	12	26-32	10		Page 55	Delete Table	2024.5.31																																																
Rated Current of Appliance (A)	AWG																																																																
1-5	18																																																																
6-10	16																																																																
11-15	14																																																																
16-25	12																																																																
26-32	10																																																																
7	<p>3.4 Dehumidification control wiring</p>  <p>HUMIDISTAT</p>		Page 56	Delete Dehumidification control wiring	2024.5.31																																																												
8	<p>1. Safety Cautions</p> <p>CAUTION: The power supply of the inverter is connected to the main power supply. If the power supply is not disconnected, the inverter may be damaged. Always disconnect the power supply before working on the inverter.</p> 		Page 64	Delete using the inverter test tool maintenance	2024.5.31																																																												
9			Page 17	Convert decimal to fraction	2024.9.																																																												
10	 <p>Minimum clearance of 1 in(25.4mm) all sides</p>	 <p>Minimum clearance of 1 in(25.4mm) all sides</p>	Page 19	Change 59ft/1.5m to 4.9ft/1.5m	2024.9.																																																												

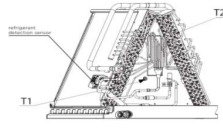
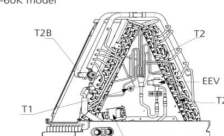
11	<p>10. Electrical Wiring Diagrams</p> <table border="1"> <thead> <tr> <th>SW1 Model</th> <th>SW1 Wiring Diagram</th> </tr> </thead> <tbody> <tr> <td>MASC-30A0V01S-0401</td> <td></td> </tr> <tr> <td>MASC-30A0V01S-0401</td> <td>16023000014232</td> </tr> <tr> <td>MASC-30A0V01S-0401</td> <td></td> </tr> <tr> <td>MASC-30A0V01S-0402</td> <td>16023000015052</td> </tr> <tr> <td>MASC-30A0V01S-0402</td> <td></td> </tr> </tbody> </table>	SW1 Model	SW1 Wiring Diagram	MASC-30A0V01S-0401		MASC-30A0V01S-0401	16023000014232	MASC-30A0V01S-0401		MASC-30A0V01S-0402	16023000015052	MASC-30A0V01S-0402		<p>10. Electrical Wiring Diagrams</p> <table border="1"> <thead> <tr> <th>SW1 Model</th> <th>SW1 Wiring Diagram</th> </tr> </thead> <tbody> <tr> <td>MASC-30A0V01S-0401</td> <td></td> </tr> <tr> <td>MASC-30A0V01S-0401</td> <td>16023000014232</td> </tr> <tr> <td>MASC-30A0V01S-0401</td> <td></td> </tr> <tr> <td>MASC-30A0V01S-0402</td> <td>16023000015052</td> </tr> <tr> <td>MASC-30A0V01S-0402</td> <td></td> </tr> </tbody> </table>	SW1 Model	SW1 Wiring Diagram	MASC-30A0V01S-0401		MASC-30A0V01S-0401	16023000014232	MASC-30A0V01S-0401		MASC-30A0V01S-0402	16023000015052	MASC-30A0V01S-0402		Page 36	Change wire diagram of 30k~60k	2024.9.																																																								
SW1 Model	SW1 Wiring Diagram																																																																																				
MASC-30A0V01S-0401																																																																																					
MASC-30A0V01S-0401	16023000014232																																																																																				
MASC-30A0V01S-0401																																																																																					
MASC-30A0V01S-0402	16023000015052																																																																																				
MASC-30A0V01S-0402																																																																																					
SW1 Model	SW1 Wiring Diagram																																																																																				
MASC-30A0V01S-0401																																																																																					
MASC-30A0V01S-0401	16023000014232																																																																																				
MASC-30A0V01S-0401																																																																																					
MASC-30A0V01S-0402	16023000015052																																																																																				
MASC-30A0V01S-0402																																																																																					
12	<p>Function combination table of SW1-1 and SW1-4</p> <table border="1"> <thead> <tr> <th>SW1</th> <th>Control type</th> <th>Stand alone or full system</th> </tr> </thead> <tbody> <tr> <td>SW1-1</td> <td>Free match</td> <td>Free match</td> </tr> <tr> <td>SW1-4</td> <td>Wired controller</td> <td>Full system</td> </tr> <tr> <td>SW1-4</td> <td>24V Thermostat</td> <td>Full system</td> </tr> <tr> <td>SW1-4</td> <td>24V Thermostat</td> <td>Stand alone</td> </tr> </tbody> </table> <p>Note: SW1-1 and SW1-4 are not applicable to the wiring method.</p>	SW1	Control type	Stand alone or full system	SW1-1	Free match	Free match	SW1-4	Wired controller	Full system	SW1-4	24V Thermostat	Full system	SW1-4	24V Thermostat	Stand alone	<p>Function combination table of SW1-1 and SW1-4</p> <table border="1"> <thead> <tr> <th>SW1</th> <th>Control type</th> <th>SW1 and ODU Connection</th> <th>Note</th> </tr> </thead> <tbody> <tr> <td>SW1-1</td> <td>Wired controller / 24V Thermostat</td> <td>G1+G2 / 24V connection</td> <td>Auto Discovery</td> </tr> <tr> <td>SW1-4</td> <td>Wired controller</td> <td>S1+S2</td> <td>Scenario 2</td> </tr> <tr> <td>SW1-4</td> <td>24V Thermostat</td> <td>S1+S2</td> <td>Scenario 1</td> </tr> <tr> <td>SW1-4</td> <td>24V Thermostat</td> <td>24V Thermostat</td> <td>Scenario 3</td> </tr> </tbody> </table>	SW1	Control type	SW1 and ODU Connection	Note	SW1-1	Wired controller / 24V Thermostat	G1+G2 / 24V connection	Auto Discovery	SW1-4	Wired controller	S1+S2	Scenario 2	SW1-4	24V Thermostat	S1+S2	Scenario 1	SW1-4	24V Thermostat	24V Thermostat	Scenario 3	Page 46	update Function combination table of SW1-1 and SW1-4	2024.9.																																													
SW1	Control type	Stand alone or full system																																																																																			
SW1-1	Free match	Free match																																																																																			
SW1-4	Wired controller	Full system																																																																																			
SW1-4	24V Thermostat	Full system																																																																																			
SW1-4	24V Thermostat	Stand alone																																																																																			
SW1	Control type	SW1 and ODU Connection	Note																																																																																		
SW1-1	Wired controller / 24V Thermostat	G1+G2 / 24V connection	Auto Discovery																																																																																		
SW1-4	Wired controller	S1+S2	Scenario 2																																																																																		
SW1-4	24V Thermostat	S1+S2	Scenario 1																																																																																		
SW1-4	24V Thermostat	24V Thermostat	Scenario 3																																																																																		
13		<p>48-60K model</p> 	Page 51	Change drawing	2024.9.																																																																																
14	<p>Model size selection</p> <p>For installations requiring supplemental heating, the optional Electric Auxiliary Heat Module is available in sizes from 3kW to 25kW to accommodate appropriate string given the specific heat load and electrical requirements of each installation. Please refer to the table below for selection of available sizes of each model, being sure to avoid improper matching.</p> <table border="1"> <thead> <tr> <th>MODEL (SW1-1)</th> <th>3kW</th> <th>5kW</th> <th>8kW</th> <th>10kW</th> <th>15kW</th> <th>20kW</th> <th>25kW</th> </tr> </thead> <tbody> <tr> <td>18K</td> <td>Y</td> <td>Y</td> <td>Y</td> <td>Y</td> <td>-</td> <td>-</td> <td>-</td> </tr> <tr> <td>20K</td> <td>-</td> <td>Y</td> <td>Y</td> <td>Y</td> <td>Y</td> <td>-</td> <td>-</td> </tr> <tr> <td>25K</td> <td>-</td> <td>-</td> <td>Y</td> <td>Y</td> <td>Y</td> <td>Y</td> <td>-</td> </tr> <tr> <td>30K</td> <td>-</td> <td>-</td> <td>-</td> <td>Y</td> <td>Y</td> <td>Y</td> <td>Y</td> </tr> </tbody> </table>	MODEL (SW1-1)	3kW	5kW	8kW	10kW	15kW	20kW	25kW	18K	Y	Y	Y	Y	-	-	-	20K	-	Y	Y	Y	Y	-	-	25K	-	-	Y	Y	Y	Y	-	30K	-	-	-	Y	Y	Y	Y	<p>Model size selection</p> <p>For installations requiring supplemental heating, the optional Electric Auxiliary Heat Module is available in sizes from 3kW to 25kW to accommodate appropriate string given the specific heat load and electrical requirements of each installation. Please refer to the table below for selection of available sizes of each model, being sure to avoid improper matching.</p> <table border="1"> <thead> <tr> <th>MODEL (SW1-1)</th> <th>3kW</th> <th>5kW</th> <th>8kW</th> <th>10kW</th> <th>15kW</th> <th>20kW</th> <th>25kW</th> </tr> </thead> <tbody> <tr> <td>18K</td> <td>Y</td> <td>Y</td> <td>Y</td> <td>Y</td> <td>-</td> <td>-</td> <td>-</td> </tr> <tr> <td>20K</td> <td>-</td> <td>Y</td> <td>Y</td> <td>Y</td> <td>Y</td> <td>-</td> <td>-</td> </tr> <tr> <td>25K</td> <td>-</td> <td>-</td> <td>Y</td> <td>Y</td> <td>Y</td> <td>Y</td> <td>-</td> </tr> <tr> <td>30K</td> <td>-</td> <td>-</td> <td>-</td> <td>Y</td> <td>Y</td> <td>Y</td> <td>Y</td> </tr> </tbody> </table>	MODEL (SW1-1)	3kW	5kW	8kW	10kW	15kW	20kW	25kW	18K	Y	Y	Y	Y	-	-	-	20K	-	Y	Y	Y	Y	-	-	25K	-	-	Y	Y	Y	Y	-	30K	-	-	-	Y	Y	Y	Y	Page 57	Add outdoor unit	2024.9.
MODEL (SW1-1)	3kW	5kW	8kW	10kW	15kW	20kW	25kW																																																																														
18K	Y	Y	Y	Y	-	-	-																																																																														
20K	-	Y	Y	Y	Y	-	-																																																																														
25K	-	-	Y	Y	Y	Y	-																																																																														
30K	-	-	-	Y	Y	Y	Y																																																																														
MODEL (SW1-1)	3kW	5kW	8kW	10kW	15kW	20kW	25kW																																																																														
18K	Y	Y	Y	Y	-	-	-																																																																														
20K	-	Y	Y	Y	Y	-	-																																																																														
25K	-	-	Y	Y	Y	Y	-																																																																														
30K	-	-	-	Y	Y	Y	Y																																																																														
15	<p>7. Engineering of Electrical Wiring</p> <p>1. Highlights of electrical wiring installation</p> <p>1.1. Before installation, please refer to the following items:</p> <ul style="list-style-type: none"> Check the power supply voltage and phase. Check the power supply capacity and wiring method. Check the power supply cable size and wiring method. Check the power supply cable length and wiring method. Check the power supply cable connection and wiring method. Check the power supply cable protection and wiring method. Check the power supply cable grounding and wiring method. Check the power supply cable labeling and wiring method. Check the power supply cable documentation and wiring method. <p>1.2. Before installation, please refer to the following items:</p> <ul style="list-style-type: none"> Check the power supply voltage and phase. Check the power supply capacity and wiring method. Check the power supply cable size and wiring method. Check the power supply cable length and wiring method. Check the power supply cable connection and wiring method. Check the power supply cable protection and wiring method. Check the power supply cable grounding and wiring method. Check the power supply cable labeling and wiring method. Check the power supply cable documentation and wiring method. <p>2. Specific wiring method</p> <p>2.1. Before installation, please refer to the following items:</p> <ul style="list-style-type: none"> Check the power supply voltage and phase. Check the power supply capacity and wiring method. Check the power supply cable size and wiring method. Check the power supply cable length and wiring method. Check the power supply cable connection and wiring method. Check the power supply cable protection and wiring method. Check the power supply cable grounding and wiring method. Check the power supply cable labeling and wiring method. Check the power supply cable documentation and wiring method. <p>3. Optional function wiring</p> <p>3.1. Before installation, please refer to the following items:</p> <ul style="list-style-type: none"> Check the power supply voltage and phase. Check the power supply capacity and wiring method. Check the power supply cable size and wiring method. Check the power supply cable length and wiring method. Check the power supply cable connection and wiring method. Check the power supply cable protection and wiring method. Check the power supply cable grounding and wiring method. Check the power supply cable labeling and wiring method. Check the power supply cable documentation and wiring method. 	<p>7. Engineering of Electrical Wiring</p> <p>1. Highlights of electrical wiring installation</p> <p>1.1. Before installation, please refer to the following items:</p> <ul style="list-style-type: none"> Check the power supply voltage and phase. Check the power supply capacity and wiring method. Check the power supply cable size and wiring method. Check the power supply cable length and wiring method. Check the power supply cable connection and wiring method. Check the power supply cable protection and wiring method. Check the power supply cable grounding and wiring method. Check the power supply cable labeling and wiring method. Check the power supply cable documentation and wiring method. <p>1.2. Before installation, please refer to the following items:</p> <ul style="list-style-type: none"> Check the power supply voltage and phase. Check the power supply capacity and wiring method. Check the power supply cable size and wiring method. Check the power supply cable length and wiring method. Check the power supply cable connection and wiring method. Check the power supply cable protection and wiring method. Check the power supply cable grounding and wiring method. Check the power supply cable labeling and wiring method. Check the power supply cable documentation and wiring method. <p>2. Specific wiring method</p> <p>2.1. Before installation, please refer to the following items:</p> <ul style="list-style-type: none"> Check the power supply voltage and phase. Check the power supply capacity and wiring method. Check the power supply cable size and wiring method. Check the power supply cable length and wiring method. Check the power supply cable connection and wiring method. Check the power supply cable protection and wiring method. Check the power supply cable grounding and wiring method. Check the power supply cable labeling and wiring method. Check the power supply cable documentation and wiring method. <p>3. Optional function wiring</p> <p>3.1. Before installation, please refer to the following items:</p> <ul style="list-style-type: none"> Check the power supply voltage and phase. Check the power supply capacity and wiring method. Check the power supply cable size and wiring method. Check the power supply cable length and wiring method. Check the power supply cable connection and wiring method. Check the power supply cable protection and wiring method. Check the power supply cable grounding and wiring method. Check the power supply cable labeling and wiring method. Check the power supply cable documentation and wiring method. 	Page 59	Change drawings	2024.9.																																																																																