



# ***Owner's Manual***

## **Original Instructions**

Wired Controller XE72-44/E

Thank you for choosing our product.  
Please read this Owner's Manual carefully before operation and  
retain it for future reference.

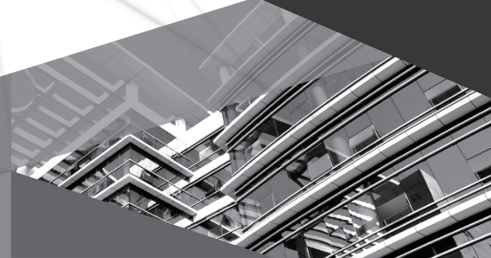

## User Notice

- ◆ Never install the wired controller in the moist circumstance or expose it directly under the sunlight.
- ◆ Never beat, throw, and frequently disassemble the wired controller and the wireless remote controller.
- ◆ Never operate the wired controller and the wireless remote controller with wet hands.
- ◆ Do not remove or install the wired controller by yourself. If there is any question, please contact our after-sales service center.
- ◆ The wired controller is a general model, applicable for several kinds of units. Some functions of the wired controller are not available for certain kinds of units, more details please refer to the owner's manual of unit. The setting of such unavailable function will not affect unit's operation.
- ◆ The wired controller is universal. The remote receiver is either in the indoor unit or in the wired controller. Please refer to the specific models.
- ◆ As for some indoor units connected with the wired controller, if use the remote controller whose set temperature is adjustable under auto mode, the wired controller will receive the mode signal of remote controller, rather than its set temperature under the auto mode.
- ◆ The wired controller is the universal component. When indoor unit has connected with the wired controller, display status of indoor unit is decided by the indoor unit. Valid status and invalid status are all belong to normal status.



**Please read the manual carefully before using and installing this product.**

# Contents

Wired Controller XE72-44/E .....	1
1 Symbols on LCD .....	1
1.1 Outside View of the Wired Controller .....	1
1.2 LCD of the Wired Controller .....	1
2 Buttons .....	2
2.1 Buttons on the Wired Controller .....	2
2.2 Function of the Buttons .....	3
3 Operation Instructions .....	4
3.1 ON/OFF .....	4
3.2 Mode Setting .....	4
3.3 Temperature Setting .....	4
3.4 Fan Setting .....	5
3.5 Timer Setting .....	5
3.6 Up & Down Swing Setting .....	6
3.7 Left & Right Swing Setting .....	7
3.8 Fresh Air Function Setting .....	8
3.9 Sleep Setting .....	9
3.10 Turbo Setting .....	10
3.11 Energy Saving Function Setting .....	11
3.12 E-heater Setting .....	12
3.13 X-fan Setting .....	13
3.14 Quiet Function Setting .....	14
3.15 Health Setting .....	15
3.16 Absent Setting .....	16
3.17 I-Demand Setting .....	16
3.18 WiFi Function Setting .....	17
3.19 Dred Function Setting .....	17
3.20 Two-way Ventilation Function Setting .....	18
3.21 Other Functions .....	19
4 Installation and Dismantlement .....	20
4.1 Connection of the Signal Line of the Wired Controller .....	20
4.2 Installation of the Wired Controller .....	20
4.3 Dismantlement of the Wired Controller .....	24
5 Errors Display .....	24

## Wired Controller XE72-44/E

### 1 Symbols on LCD

#### 1.1 Outside View of the Wired Controller

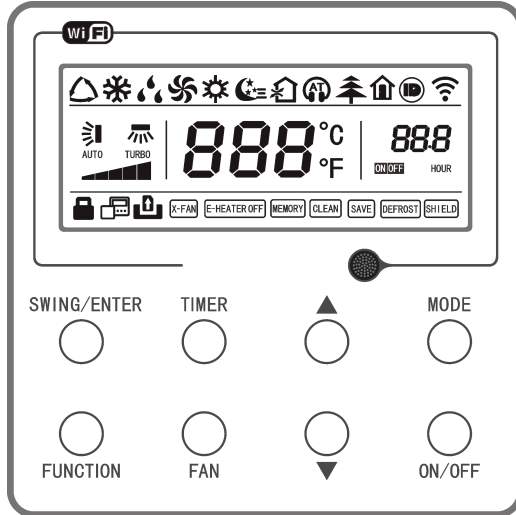

Fig.1 Outside View of the Wired Controller

#### 1.2 LCD of the Wired Controller

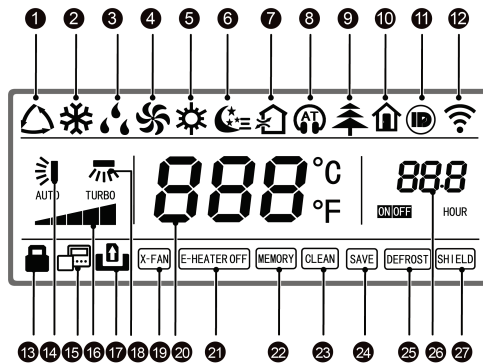

Fig.2 LCD of the Wired Controller

Table 1

No.	Display	Instruction of Display
1	Auto	Automatic mode (under auto mode, the indoor unit will select its operating mode according to the variation of room temperature)
2	Cool	Cooling mode
3	Dry	Dry mode
4	Fan	Fan mode
5	Heat	Heating mode
6	Sleep	Display when sleep function is set
7	Fresh air	Display when fresh air function is set
8	Quiet	Display when quiet function is set
9	Health	Display when health function is set
10	Absent	Display when absent function is set
11	I-DEMAND	Display when I-DEMAND function is set
12	WiFi	Display when WiFi function is set
13	Child-lock	Child-lock status, display when child-lock function is set
14	Up & down swing	Display when up and down swing function is set
15	Slave wired controller	Icon of slave wired controller, it will display when slave wired controller is set (this function is unavailable for this unit)
16	Fan speed	The fan speed set currently (including auto, low, medium low, medium, medium high, high, and turbo)
17	No card	No card in gate control system
18	Left & right swing	Display when left and right swing function is set
19	X-fan	Display when X-fan function is set
20	Temperature	It will display the setting temperature
21	E-heater	On/off switch of auxiliary heating
22	Memory	Memory status (After power failure and re-energizing the unit, it will resume to ON/OFF status of unit before the power failure)
23	Clean	Filter washing reminder (this function is unavailable for this unit)
24	Save	Display when energy-saving function is set
25	Defrost	Defrosting status
26	Timer	Display when timer status is set
27	Shield	Shielding status

## 2 Buttons

### 2.1 Buttons on the Wired Controller

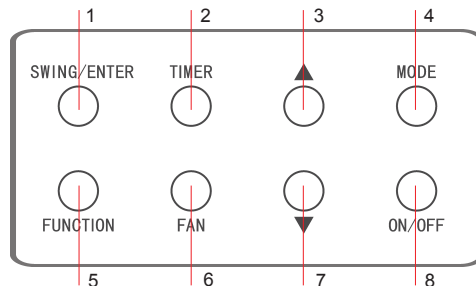

Fig. 3 Buttons on the Wired Controller

## 2.2 Function of the Buttons

Table 2

No.	Name	Function
1	SWING/ENTER	① Function selection and cancellation. ② Setting of the up and down swing function.
3	▲	① Running temperature setting of the indoor unit, range:61~86°F(16~30 ℃). ② Timer setting, range:0.5-24 hr.
7	▼	
6	FAN	Setting of the auto/low/medium low/medium/medium high/ high fan speed.
4	MODE	Setting of the Cooling/Heating/Fan/Dry/Auto mode of the indoor unit.
5	FUNCTION	Switchover among the functions of Turbo/WiFi/E-heater/X-fan etc..
2	TIMER	Timer setting.
8	ON/OFF	Turn on/off the indoor unit.
3+4	▲+MODE	Press them for 5s under off state of the unit to Enter/Cancel the Memory function(If memory is set, indoor unit after power failure and then power recovery will resume the original setting state. If not, the indoor unit is defaulted to be off after power recovery. Memory off is default before delivery.).
6+7	FAN+▼	By pressing them at the same time under off state of the unit, ☒ will be displayed on the wired controller for the cooling only unit, while ☓ will be displayed on the wired controller for the cooling and heating unit.
3+7	▲+▼	Upon startup of the unit without malfunction or under off state of the unit,press them at the same time for 5s to enter the lock state, in which case, any other buttons won't respond the press. Repress them for 5s to quit this state.
4+7	MODE+▼	Under OFF state, the Celsius and Fahrenheit scales can be switched by pressing "MODE" and "▼" for 5s.
2+5	TIMER+FUNCTION	Under OFF state, it is available to go to the commissioning status by pressing "FUNCTION" and "TIMER" for five seconds, and let "00" displayed on the temperature display area by pressing "MODE", then adjust the options which is shown on the timer area by pressing "▲" and "▼". There are totally four options, as follows: ① Indoor ambient temperature is sensed by the return air temperature sensor ( 01 displayed on the timer area). ② Indoor ambient temperature is sensed by the wired controller (02 displayed on the timer area). ③ The return air temperature sensor is selected under the cooling, dry, or fan mode; while the wired controller temperature sensor is selected under the heating or auto mode. (03 is displayed on the timer area). ④ The wired controller temperature sensor is selected under the cooling, dry, or fan mode; while the return air temperature sensor is selected under the heating mode. (04 is displayed on the timer display area).
2+5	TIMER+FUNCTION	Under OFF state, it is available to go to the commissioning status by pressing "FUNCTION" and "TIMER" for five seconds. Press "MODE" button until "01" icon is shown at the temperature display area. The setting status will be shown at timer area. Press "▲" and "▼" button to adjust and two options are available: ① Three low levels (01); ② Three high levels (02).
5+6	FUNCTION + FAN	Reset the WiFi function: Under off status, press "FUNCTION" + "FAN" combination buttons on its wired controller for 5s. Once "oC" is displayed, this indicates that reset was successful.

### 3 Operation Instructions

#### 3.1 ON/OFF

Press ON/OFF to turn on the unit and turn it off by another press.

Note: The state shown in Fig.4 indicates the “OFF” state of the unit after power on. The state shown in Fig.5 indicates the “ON” state of the unit after power on.

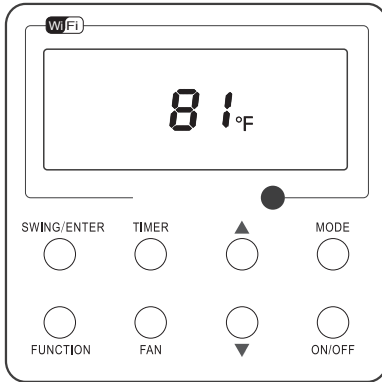

Fig. 4 “OFF” State

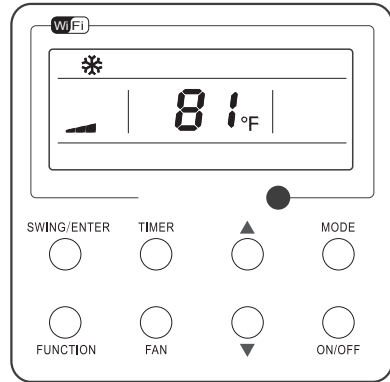
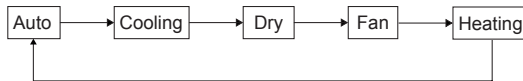

Fig. 5 “ON” State

#### 3.2 Mode Setting

Under the “ON” state of the unit, press MODE to switch the operation modes as the following sequence:Auto-Cooling-Dry-Fan-Heating.



#### 3.3 Temperature Setting

Press ▲ or ▼ to increase/decrease the preset temperature. If press either of them continuously, the temperature will be increased or decreased by 1°F(1℃) every 0.5s, as shown in Fig.6.

In the Cooling, Dry, Fan or Heating mode, the temperature setting range is 61°F~86°F(16℃~30℃).

In the Auto mode, the setting temperature is unadjustable.

Note:

If the wired controller receives the signals of remote controller, the wired controller can analyze the set temperature adjustment function of automatic mode of the remote controller, but it needs to be used with an indoor unit with the set temperature adjustment function of automatic mode.

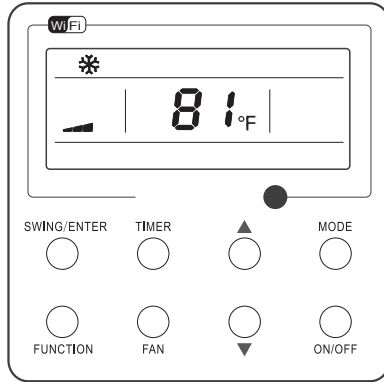

Fig.6

### 3.4 Fan Setting

Under the “ON” State of the unit, press Fan and then fan speed of the indoor unit will change circularly as shown in Fig.7.

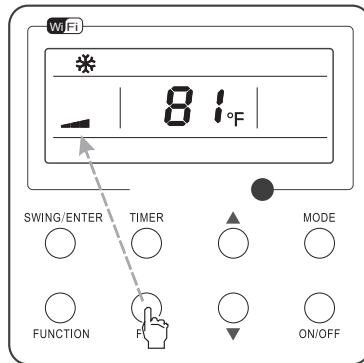
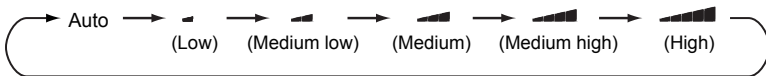

Fig.7

### 3.5 Timer Setting

Under the “ON”/“OFF” state of the unit, press Timer to set timer off/on.

Timer on setting: press Timer, and then LCD will display “xx.x hour”, with “hour” blinking. In this case, press ▲ or ▼ to adjust the timing value. Then press SWING/ENTER to confirm the setting.

Timer off setting: press Timer, if LCD won't display xx.x hour, and then it means the timer setting is canceled.

Timer off setting under the “ON” state of the unit is shown as Fig.8.



### 3.7 Left & Right Swing Setting

Swing On: Press FUNCTION under on state of the unit to activate the swing function. In this case,  will blink. After that, press SWING/ENTER to make a confirmation.

Swing Off: When the Swing function is on, press FUNCTION to enter the Swing setting interface, with  blinking. After that, press SWING/ENTER to cancel this function.

Swing setting is shown as Fig.9.

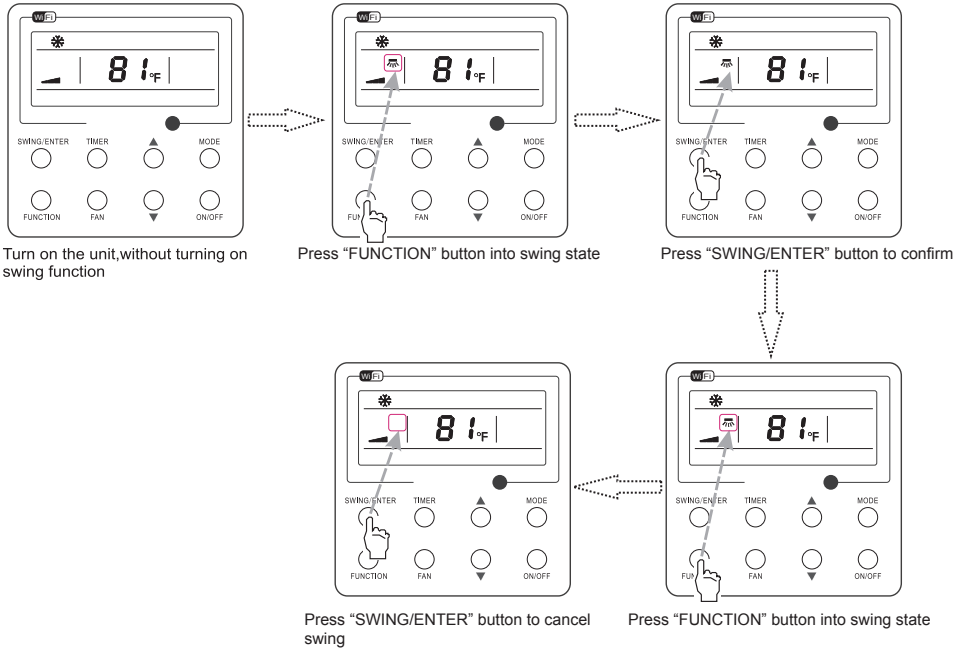



Fig. 9 Swing Setting

Note:

- ① . Sleep, Turbo or X-fan setting is the same as the Swing setting.
- ② . After the setting has been done, it has to press the key "SWING/ENTER" to back to the setting status or quit automatically five seconds later.

### 3.8 Fresh Air Valve Function Setting

Turn on fresh air valve function:

Under unit on status, press FUNCTION button on the panel to select “Fresh air valve” function option. When  icon flashes, it enters fresh air valve setting mode. Previous temperature display position will display the level of fresh air valve. Press ▲ or ▼ button to adjust the level of fresh air valve within the range from 1 to 10. Then press SWING/ENTER button to activate this function.

Turn off fresh air valve function:

If fresh air valve function has been set, press FUNCTION button on the panel to select “Fresh air valve” function option. When  icon flashes, if you press SWING/ENTER button without pressing ▲ or ▼ button, fresh air valve function will be canceled; if you press SWING/ENTER button after pressing ▲ or ▼ button, fresh air valve function will be activated.

Note:

1. if you press panel button to set fresh air valve function on, ventilation (ventilation 1) function will be activated too; if you press panel button to set fresh air valve function off, ventilation function will be canceled too.
2. This function is invalid when working with the model with two-way ventilation system.

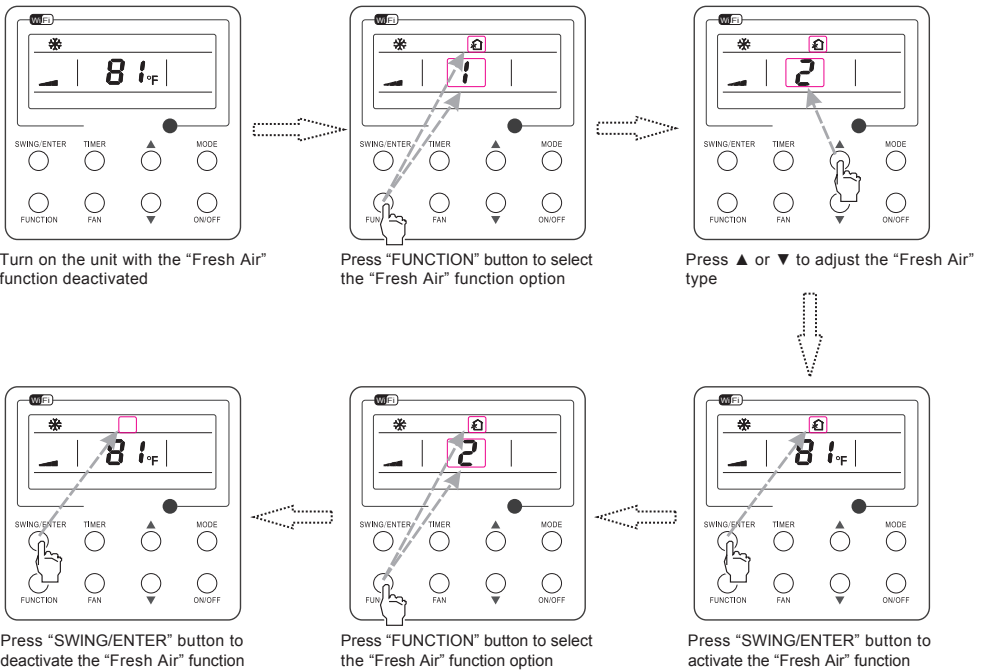

Fig. 10 Fresh Air Valve Function Setting

### 3.9 Sleep Setting

Sleep on: Press FUNCTION under ON state of the unit till the unit enters the Sleep setting interface. Press SWING/ENTER to confirm the setting.

Sleep off: When the Sleep function is activated, press FUNCTION to enter the Sleep setting interface. After that, press SWING/ENTER to can this function.

Sleep setting is shown as Fig.11.

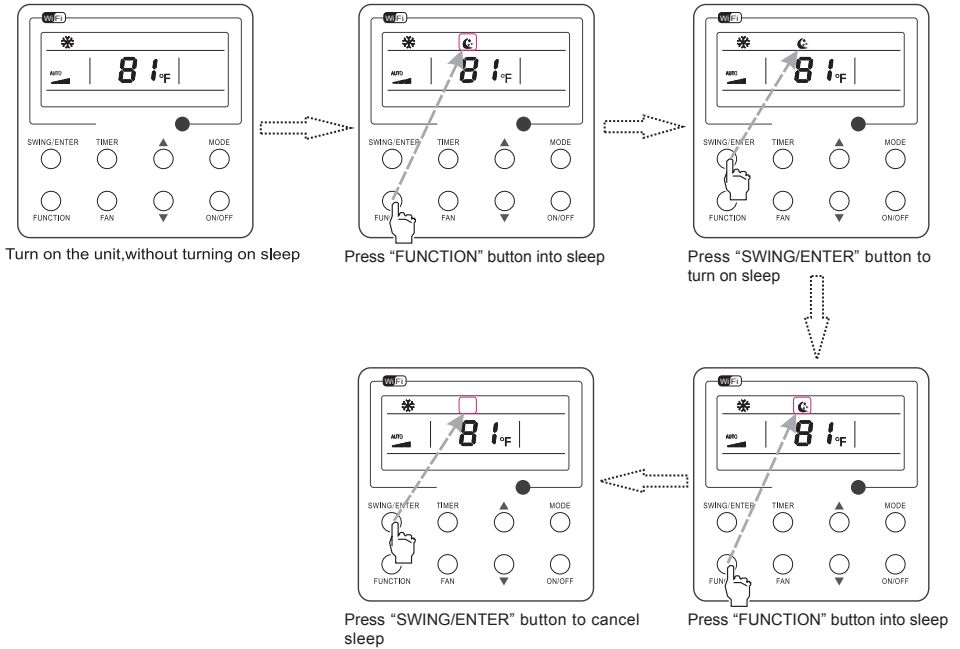

Fig. 11 Sleep Setting

### 3.10 Turbo Setting

Turbo function: The unit at the high fan speed can realize quick cooling or heating so that the room temperature can quickly approach the setting value.

In the Cooling or Heating mode, press FUNCTION till the unit enters the Turbo setting interface and then press SWING/ENTER to confirm the setting.

When the Turbo function is activated, press FUNCTION to enter the Turbo setting interface and then press SWING/ENTER to cancel this function.

Turbo function setting is as shown in Fig.12.

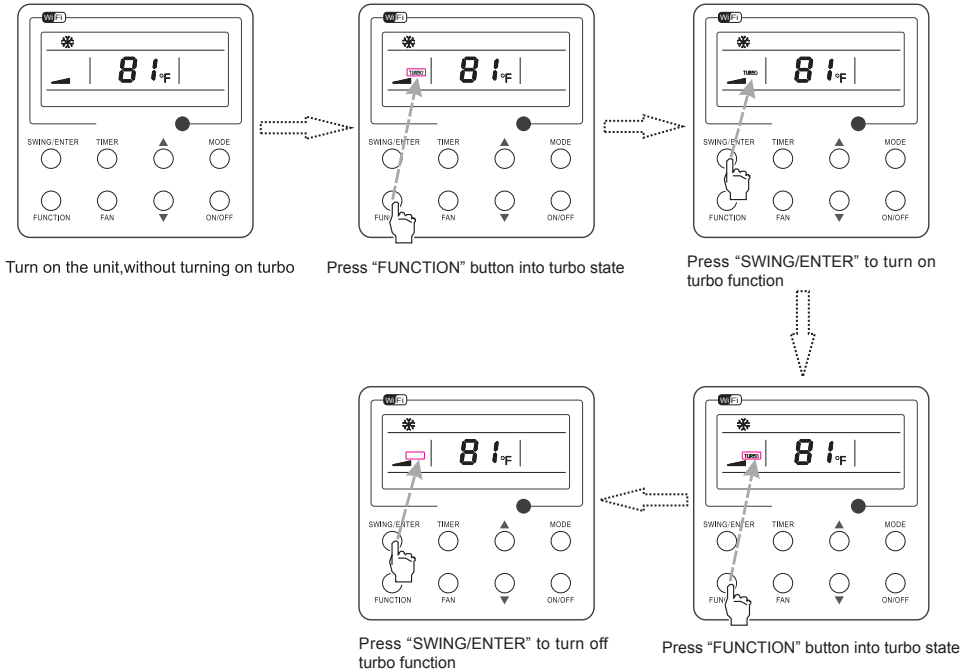

Fig.12 Turbo Setting

### 3.11 Energy Saving Function Setting

Turn on energy saving function:

1) Energy Saving Setting for Cooling

When the unit runs under the COOL or DRY mode, press FUNCTION button to select "SAVE" function option, with "SAVE" flashing, and then press ▲ or ▼ to adjust the lower limit, after that, press the SWING/ENTER button to activate this function.

2) Energy Saving Setting for Heating

When the unit runs under the HEAT mode, press FUNCTION button to select "SAVE" function option, with "SAVE" flashing, and then press ▲ or ▼ to adjust the upper limit, after that, press SWING/ENTER button to activate this function.

Note:

under energy saving setting mode, press "MODE" button to switch the energy saving setting for COOL or HEAT mode.

Cancel energy saving function:

If energy saving function has been set, press FUNCTION button on the panel to select "SAVE" function option. When **SAVE** icon flashes, if you press SWING/ENTER button without pressing ▲ or ▼ button, energy saving function will be canceled; if you press SWING/ENTER button after pressing ▲ or ▼ button, energy saving function will be activated.

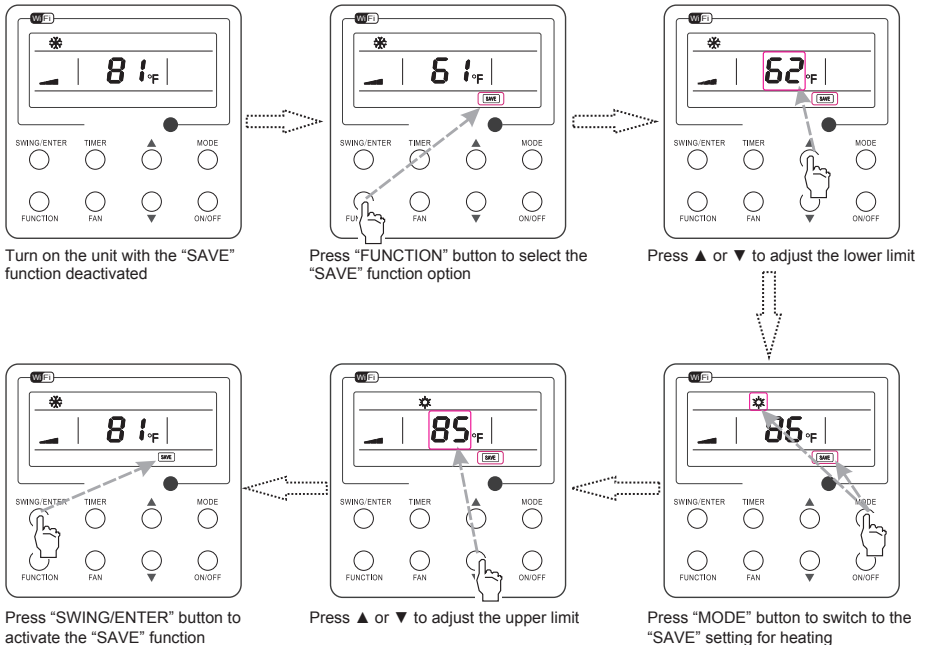

Fig. 13 Energy Saving Function Setting

### 3.12 E-heater Setting

E-heater (auxiliary electric heating function): In the Heating mode, E-heater is allowed to be turned on for improvement of efficiency.

Once the wired controller or the remote controller enters the Heating mode, this function will be turned on automatically.

Press FUNCTION in the Heating mode to enter the E-heater setting interface and then press SWING/ENTER to cancel this function.

Press FUNCTION to enter the E-heater setting interface, if the E-heater function is not activated, and then press SWING/ENTER to turn it on.

The setting of this function is shown as Fig.14 below:

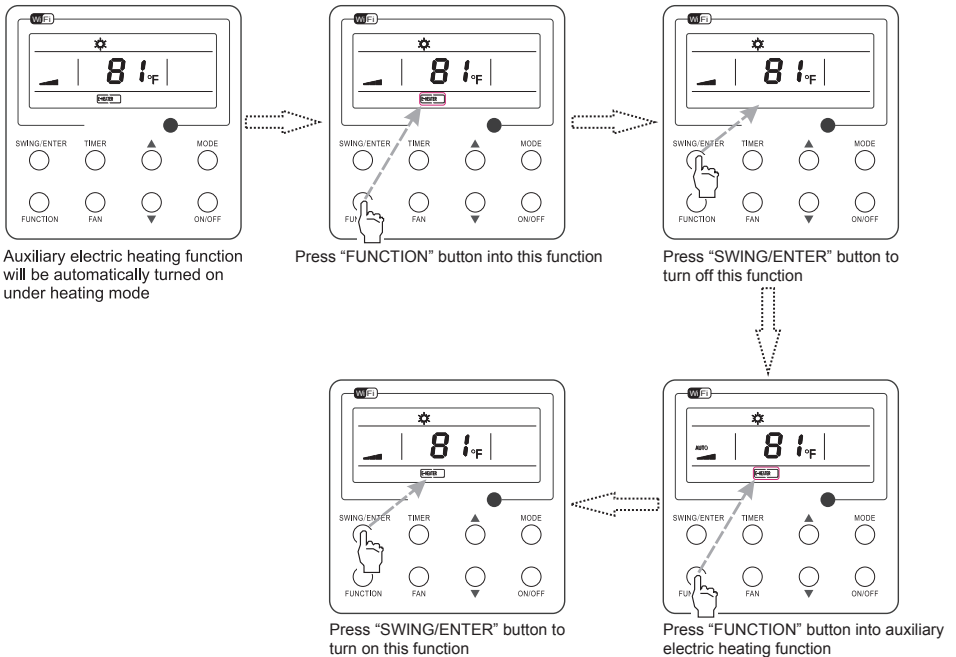

Fig.14 E-heater Setting

### 3.13 X-fan Setting

X-fan function: After the unit is turned off, the water in evaporator of indoor unit will be automatically evaporated to avoid mildew.

In the Cooling or Dry mode, press FUNCTION till the unit enters the X-fan setting interface and then press SWING/ENTER to activate this function.

When the X-fan function is activated, press FUNCTION to the X-fan setting interface and then press SWING/ENTER to cancel this function.

X-fan function setting is as shown in Fig.15

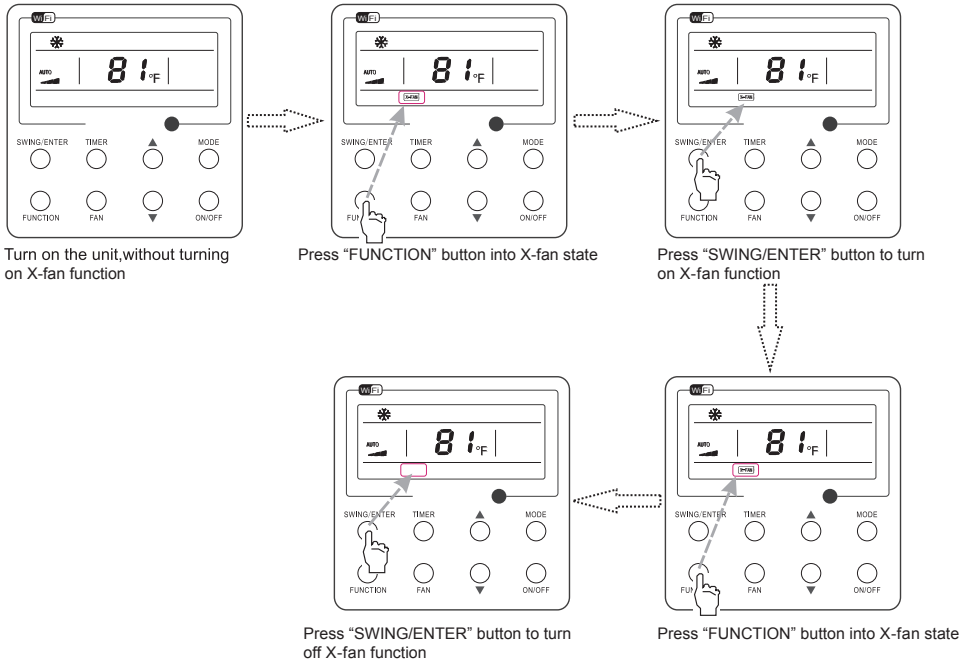

Fig.15 X-fan Setting

**Notes:**

① . When the X-fan function is activated, if turning off the unit by pressing ON/OFF or by the remote controller, the indoor fan will run at the low fan speed for 2 min, with "X-FAN" displayed on the LCD. While, if the X-fan function is deactivated, the indoor fan will be turned off directly.

② . X-fan function is unavailable in the Fan or Heating mode.

### 3.14 Quiet Function Setting

Turn on quiet function:

Under unit on status, press FUNCTION button on the panel to select “Quiet” function option. When “Quiet” or “Auto quiet” flashes, it enters quiet function setting mode. Press ▲ or ▼ button to switch between “Quiet” and “Auto quiet” function. Then press SWING/ENTER button to activate this function.

Cancel quiet function:

If quiet function has been set, press FUNCTION button on the panel to select “Quiet” function option. When “Quiet” or “Auto quiet” flashes, if you press SWING/ENTER button without pressing ▲ or ▼ button, quiet function will be canceled; if you press SWING/ENTER button after pressing ▲ or ▼ button, quiet function will be activated.

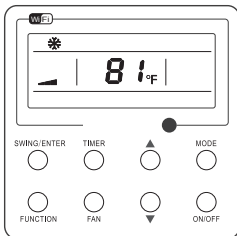

Turn on the unit with the “Quiet” function deactivated

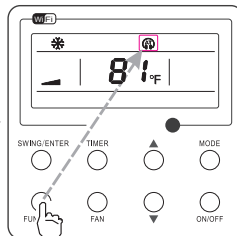

Press “FUNCTION” button to select the “Quiet” function option

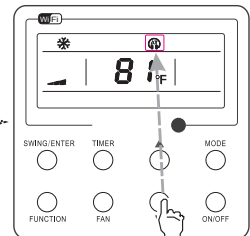

Press ▲ or ▼ to select the desired type, “QUIET” or “AUTO QUIET”.

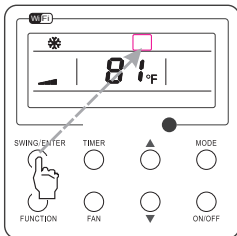

Press “SWING/ENTER” button to deactivate this function

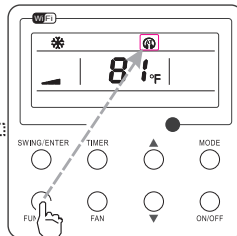

Press the Function button to select the “Quiet” function option

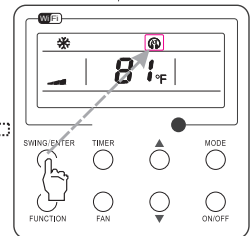

Press “SWING/ENTER” button to activate this function

Fig. 16 Setting of Quiet Function

### 3.15 Health Setting

Health on: Press FUNCTION under on state of the unit till the unit enters the Health setting interface. Press SWING/ENTER to confirm the setting.

Health off: When the Health function is activated, press FUNCTION to enter the Health setting interface. After that, press SWING/ENTER to cancel this function.

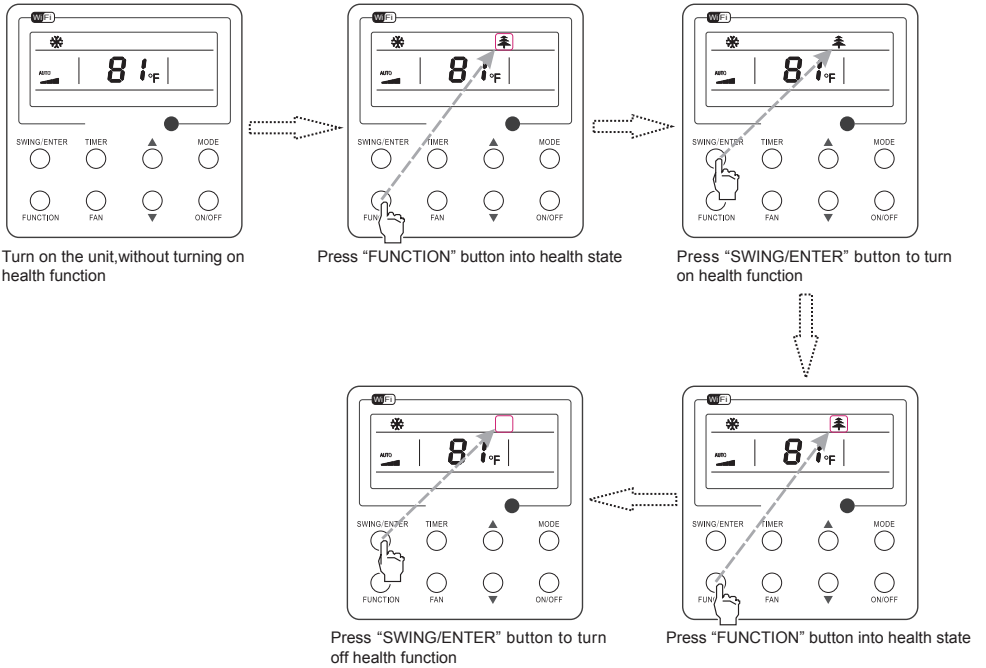

Fig. 17 Health Setting

### 3.16 Absent Setting

Absent on: Press FUNCTION under on state of the unit till the unit enters the Absent setting interface. Press SWING/ENTER to confirm the setting.

Absent off: When the Absent function is activated, press FUNCTION to enter the Absent setting interface. After that, press SWING/ENTER to cancel this function.

Note:

- 1.This function is only available in heating mode.
- 2.When this function has been set, set temperature is displayed in 46°F(8°C). In this case, temperature setting and fan speed setting are shielded.
- 3.This function will be cancelled when switching modes.
4. This function and sleep function cannot be on simultaneously. If Absent function is set firstly and then sleep/quiet function is set, Absent function will be cancelled while sleep function will be valid, and vice versa.

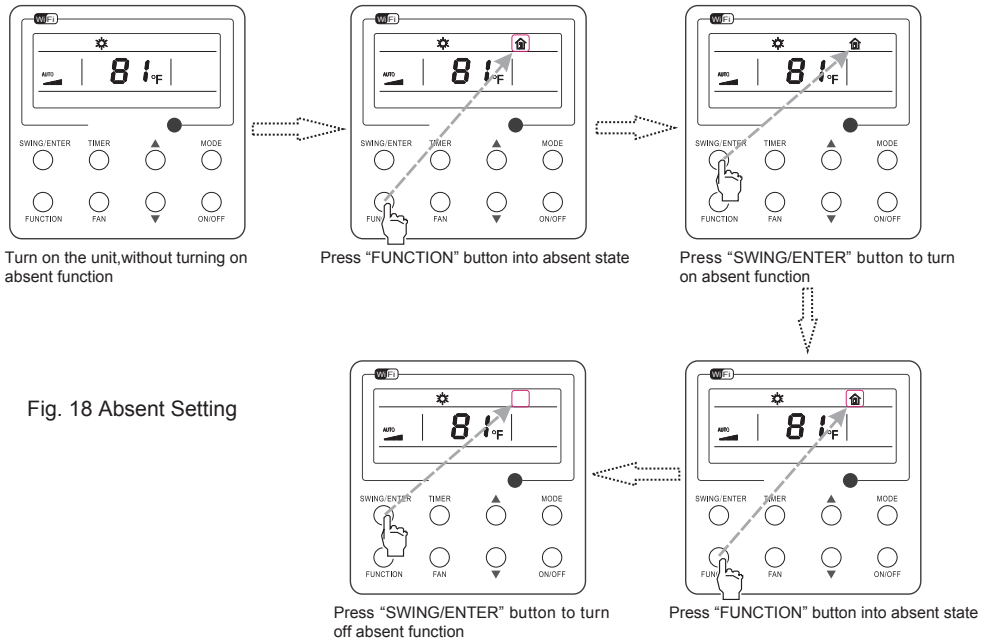

Fig. 18 Absent Setting

### 3.17 I-Demand Setting

I-Demand on: Press FUNCTION under on state of the unit till the unit enters the I-Demand setting interface. Press SWING/ENTER to confirm the setting.

I-Demand off: When the I-Demand function is activated, press FUNCTION to enter the I-Demand setting interface. After that, press SWING/ENTER to cancel this function.

Note:

- 1.This function is only available in cooling mode.
- 2.When this function has been set, set temperature is displayed in SE. In this case, temperature setting and fan speed setting are shielded.
- 3.This function will be cancelled when switching modes.
4. This function and sleep function cannot be on simultaneously. If I-demand function is set firstly and then sleep/quiet function is set, I-demand function will be cancelled while sleep function will be valid, and vice versa.

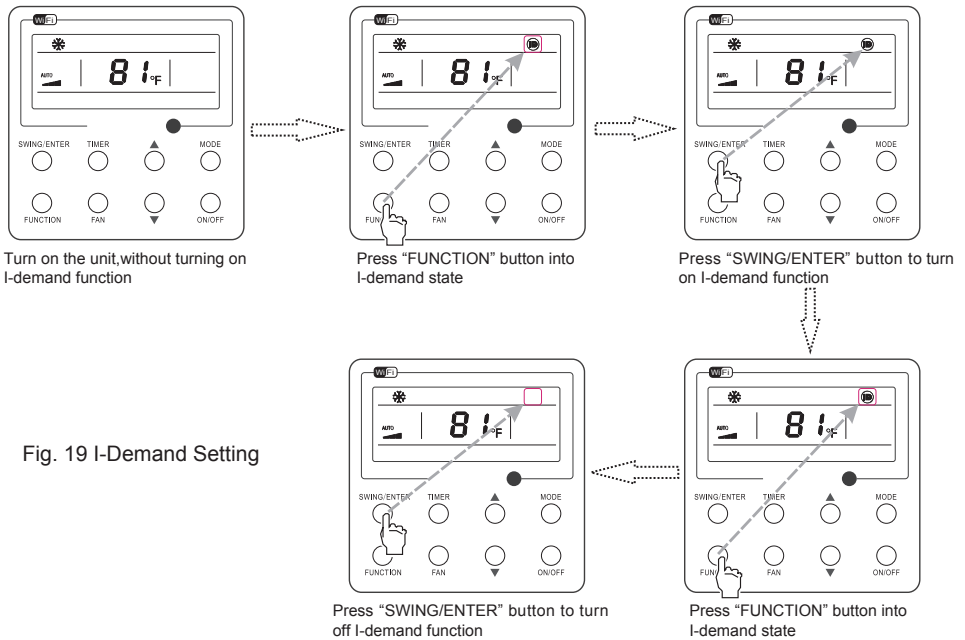

Fig. 19 I-Demand Setting

### 3.18 WiFi Function Setting

APP can be used to control it. Please scan the QR code to download it.

APP can only set some common functions of WiFi wired controller: ON/OFF, mode, set temperature, FAN speed, etc.

When using the APP for the first time, please reset the WiFi function of wired controller (reset WiFi to ex-factory setting): Under off status, press "FUNCTION" + "FAN" combination buttons on its wired controller for 5s. Once "oC" is displayed, this indicates that reset was successful.

If there is a communication failure for WiFi, after resetting WiFi, the temperature display area of wired controller displays "JF" for 5 seconds, which indicates that the current reset is invalid.

Press FUNCTION under on state of the unit till the unit enters the WiFi setting interface, the temperature area will display the WiFi status. Press "▲" or "▼" button to turn on WiFi ("ON" is displayed) or turn off WiFi ("OFF" is displayed), and then press "SWING/ENTER" button to confirm it.

**Note:**

WiFi can be only be reset or turned off by the buttons on the wired controller rather than the remote controller.

WiFi networking performance is related to the distance between the wired controller and the router and the obstacles between them. During the installation process, the distance between the wired controller and the router should be as close as possible, and the obstacles should be as little as possible.

If the WiFi signal is not good, use the WiFi signal enhanced router.

The specific situation depends on the actual installation.

### 3.19 Dred Function Setting

When outdoor unit enters DRED mode: when it detects DRED signal, the whole unit executes DRED mode. When it enters DRED mode, the outdoor unit does timekeeping and feeds back the signal to indoor unit. Under power-on state, the set temperature area displays corresponding code, DRED1, DRED2, DRED3 correspond to "d1", "d2", "d3". The panel cannot be used to set the DRED mode.

When indoor unit enters DRED mode: under power-on state, use "Function" button on the panel to switch to "DRED" function. The set temperature area will display DRED state and flicker. Through "▲" and "▼" buttons can select DRED2 (set temperature area displays d2), DRED3 (set temperature area displays d3), or turn off DRED (set temperature area displays "--"); press "SWING/ENTER" button to confirm the selection, it will display the set state for 3 seconds. After entering the setting, if there is no button operation for 5 seconds, it will quit the interface without saving the setting.

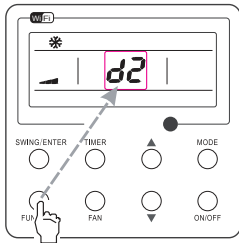

Press "FUNCTION" button to select the "DRED" function option

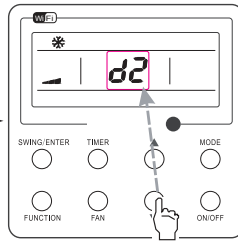

Press ▲ or ▼ to select the desired type, "DRED2" or "DRED3" or "turn off DRED"

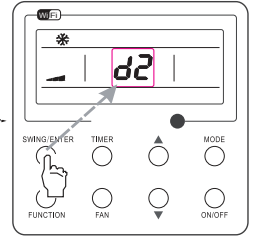

Press "SWING/ENTER" button to activate this function

Setting of DRED Function

**Note:**

- DRED mode startup method is set by indoor units.
- When outdoor unit enters DRED mode: it does not receive the DRED control of remote control, the whole unit will run the DRED mode, and the wired controller displays the state only.
- When indoor unit enters DRED mode:
  - (1). When the wired controller receives the DRED command sent from remote control, the set temperature area displays d2 or d3, and it will display for 3 seconds.
  - (2). Under power-off or air supply mode, the DRED mode is turned off.

3.20 Two-way Ventilation Function Setting

Under the "On"/ "Off" state of the unit, press Function button on the panel to select "Two-way Ventilation"function option.Then press SWING/ENTER button to start up or turn off two-way ventilation function.When two-way ventilation function is started up,  will be shown on wired controller.

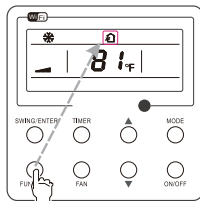

Press "FUNCTION" button to select the "Two-way Ventilation" function option

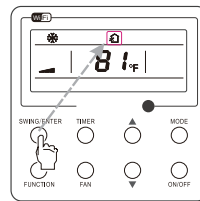

Press "SWING/ENTER" button to activate the "Two-way Ventilation" function

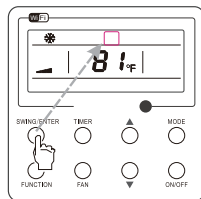

Press "SWING/ENTER" button to deactivate the "Two-way Ventilation" function

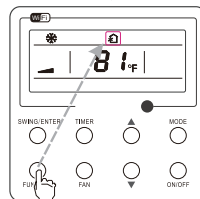

Press "FUNCTION" button to select the "Two-way Ventilation" function option

Two-way Ventilation Function Setting

**Note:**

- Switch to power-off status, two-way ventilation function is turned off.
- In power-off status, if the two-way ventilation function is activated, fan speed can be adjusted by fan speed button, and quiet or turbo function can be set.
- This function is invalid when working with the model without two-way ventilation system.

### 3.21 Other Functions

#### (1). Lock

Upon startup of the unit without malfunction or under the "OFF" state of the unit, press ▲ and ▼ at the same time for 5s till the wired controller enters the Lock function. In this case, LCD displays

. After that, repress these two buttons at the same time for 5s to quit this function.

Under the Lock state, any other button press won't get any response.

#### (2). Memory

Memory switchover: Under the "OFF" state of the unit, press Mode and ▲ at the same time for 5s to switch memory states between memory on and memory off. When this function is activated, Memory will be displayed. If this function is not set, the unit will be under the "OFF" state after power failure and then power recovery.

Memory recovery: If this function has been set for the wired controller, the wired controller after power failure will resume its original running state upon power recovery. Memory contents: ON/OFF, Mode, set temperature, set fan speed and Lock function.

#### (3). Selection of the Temperature Sensor

Under OFF state of the unit, press both "FUNCTION" and "TIMER" for five seconds to go the commissioning status. Under this status, adjust the display in the temperature display area to "00" through the button "MODE", and then adjust the option of the temperature sensor in the timer display area through the button ▲ or ▼.

- ① . Indoor ambient temperature is sensed at the return air inlet(01 in the timer display area).
- ② . Indoor ambient temperature is the sensed at the wired controller(02 in the timer display area).
- ③ . Select the temperature sensor at the return air inlet under the cooling, dry and fan modes, while select the temperature sensor at the wired controller under the heating and auto modes.(03 in the timer display area).
- ④ . Select the temperature sensor at the wired controller under the cooling, dry and fan modes, and select the temperature sensor at the return air inlet under the heating mode and auto modes (04 displayed in the timer display area).

After the setting, press "SWING/ENTER" to make a confirmation and quit this setting status.

Pressing the button "ON/OFF" also can quit this commissioning status but the set data won't be memorized.

Under the commissioning status, if there is no any operation in 20 seconds after the last button press, it will back to the previous state without memorizing the current data.

**Note:**

After connected with indoor unit, if the type of ambient temperature sensor has not been manually set, the wired controller will select the ambient temperature sensor according to the model of connected IDU; if it connects to cassette type IDU, duct type IDU, floor ceiling type IDU, ceiling type IDU, it will adopt ③, otherwise it will adopt ①. If the type of ambient temperature sensor is set manually, the wired controller will subject to the manual setting, and will not set according to automatic IDU model selection.

#### (4). Selection of the Fan Speed

Under OFF state of the unit, press both the buttons "FUNCTION" and "TIMER" for five seconds to go to the commissioning status, and then adjust the display in the temperature display area to 01 through the button "MODE" and adjust the setting of the fan speed, which comes to two options.

01: Three low fan speeds; 02: Three high fan speeds

After the setting, press "SWING/ENTER" to make a confirmation and quit this setting status.

Pressing the button "ON/OFF" also can quit this commissioning status but the set data won't be memorized.

Under the commissioning status, if there is no any operation in 20 seconds after the last button press, it will back to the previous state without memorizing the current data.

(5) Inquiry of Ambient Temperature

Under off or on status, press and hold "SWING/ENTER" button for 5 seconds to enter into ambient temperature inquiry interface, then timer area displays the ambient temperature type 01 or 02, and ambient temperature area displays the corresponding ambient temperature of corresponding type. In which, 01 refers to outdoor ambient temperature, 02 refers to indoor ambient temperature. Press "MODE" button can switch between type 01 and 02. Press buttons other than "MODE" or when the unit receives remote control signal, it will quit the inquiry status. If there is no any operation for 5 seconds, it will quit automatically.

## 4 Installation and Dismantlement

### 4.1 Connection of the Signal Line of the Wired Controller

- Open the cover of the electric control box of the indoor unit.
- Let the single line of the wired controller through the soleplate of wired controller.
- Connect the signal line of the wired controller to the 4-pin socket of the indoor unit .
- The communication distance between the main board and the wired controller can be up to 20 meters ( the standard distance is 8 meters)

### 4.2 Installation of the Wired Controller

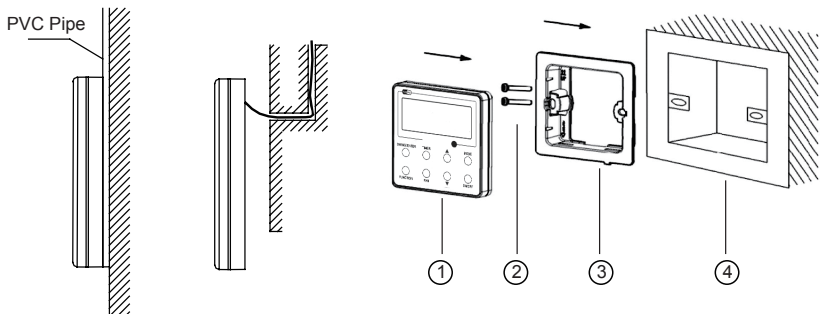

Fig. 20 Accessories for the Installation of the Wired Controller

Table 3

No.	1	2	3	4
Name	Front Panel of the Wired Controller	Screw M4X25	Soleplate of the Wired Controller	Socket box embedded in the wall

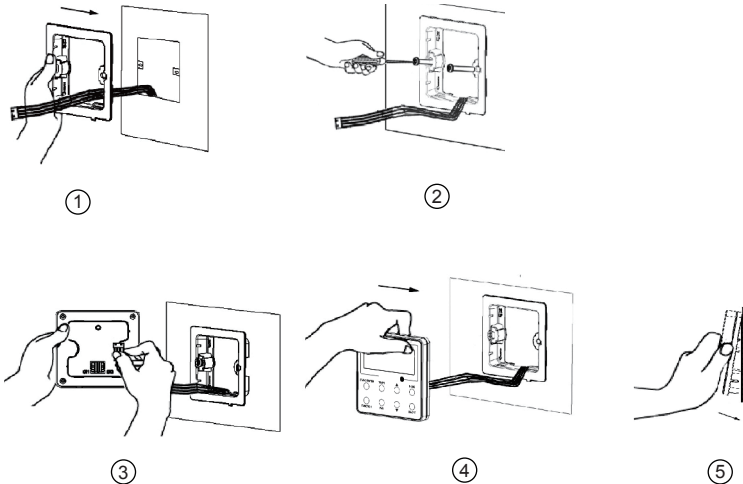

Fig. 21

**Note:**

CN1 is 485 communication interface and it used Wired Controller XE72-44/E for connecting the 4-core communication wire. These two needle stands(CN2、 CN3) are used for connecting the smart zone controller. There is no sequence for these two needle stands. You can connect one or two needle stand(s) basing on the requirement.

Fig. 21 shows the installation steps of the wired controller, but there are some issues that need your attention.

- (1). Prior to the installation, please firstly cut off the power supply of the wire buried in the installation hole, that is, no operation is allowed with electricity during the whole installation.
- (2). Pull out the four-core twisted pair line from the installation holes and then let it go through the rectangular hole behind the soleplate of the wired controller.
- (3). Stick the soleplate of wired controller on the wall and then use screw M4×25 to fix soleplate and installation hole on wall together.
- (4). Insert the four-core twisted pair line into the slot of the wired controller and then buckle the front panel and the soleplate of the wired controller together.

For matching with different models, the patch cord and the connection wire are provided in the packaging box of wired controller. As shown in fig. 22.

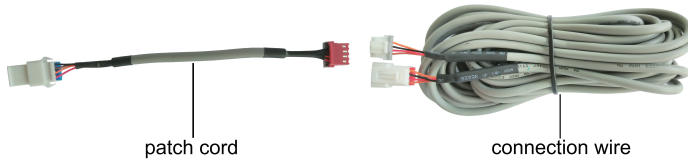

Fig. 22: Schematic diagram of patch cord and connection wire

- If the air conditioner has been installed with the patch cord (fig. 24) used for connecting the wired controller.

Only use the connection wire (fig. 23) in the packing box of wired controller. Connect the terminal ② to the terminal ④ of patch cord which has been installed on the air conditioner; insert terminal ① to needle stand CN1 of wired controller. If there's protection terminal ③, pull out the protection terminal at first and then install it.



Fig. 23: Schematic diagram of connection wire: Connect terminal① with wired controller CN1; connect terminal ② with the terminal ④ of patch cord

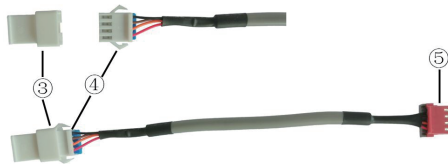

Fig. 24: Schematic diagram of patch cord: Terminal③ is the protection terminal; connect terminal ④ to the terminal ② of connection wire ; connect terminal ⑤ to the terminal of wired controller of air conditioner

- If the air conditioner hasn't been installed with the patch cord used for connecting the wired controller.
- Use the connection wire and patch cord in the packing box of wired controller. Pull out the protection terminal of patch cord at first, connect the connection wire with the patch cord according to fig. 25, and then insert the terminal ① of connection wire into the needle stand CN1 of wired controller and insert the terminal ⑤ of patch cord into the terminal of wired controller of air conditioner as well.

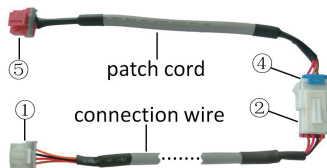

Fig. 25: Schematic diagram after the connection wire and the patch cord have been connected: connect the terminal ② of connection wire and the terminal ④ of patch cord

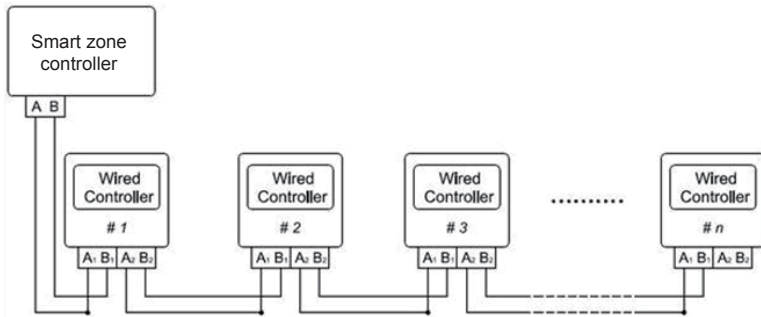

Fig. 26

Fig. 26 shows the schematic diagram of control system connection. XE72-44/E can connect the smart zone controller (integrated control system). “n” indicates the number of communication node address (programmable wired controller XE72-44/E). The complete system is composed of the smart zone controller, wired controller XE72-44/E and communication cable. The wired controller XE72-44/E can support 16 communication node addresses at the most ( $n \leq 16$ ). Terminal A and terminal B of the smart zone controller are respectively connected to the corresponding communication needle stand terminal of the #1 wired controller by the communication cable; the other needle stand of #1 wired controller is connected to the #2 wired controller through the telecommunication cable and so forth until connect to the #n wired controller. Except the last wired controller in the control system (only use CN2 or CN3, and the other one will not be connected), there’s no the sequence and the importance for the wired controller. The series number in the figure is only for the sake of clarity.

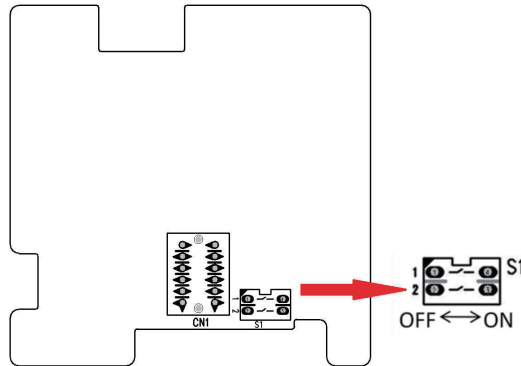

Fig. 27

Fig. 27 shows schematic diagram of DIP switch. There is a 2-bit DIP switch on the main board of wired controller XE72-44/E. As for the last #n wired controller in the control system, the 1-bit and the 2-bit of the DIP switch should be manually pulled to position “on” and position “off” respectively. The DIP switches of other wired controllers should be kept at the initial ex-factory status (1-bit and 2-bit are set at position “off”).

**⚠ CAUTION!**

Please pay special attention to the followings during the connection to avoid the malfunction of the air conditioning unit due to electromagnetic interference.

- ① . Separate the signal and communication lines of the wired controller from the power

cord and connection lines between the indoor and outdoor unit, with a minimum interval of 20cm, otherwise the communication of the unit will probably work abnormally.

② . If the air conditioning unit is installed where is vulnerable to electromagnetic interference, then the signal and communication lines of the wired controller must be the shielding twisted pair lines.

### 4.3 Dismantlement of the Wired Controller

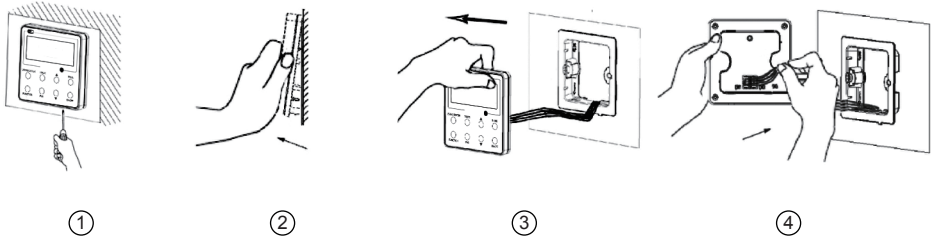

## 5 Errors Display

If there is an error occurring during the operation of the system, the error code will be displayed on the LCD, as show in Fig. 28. If multi errors occur at the same time, their codes will be displayed circularly.

**Note:** In event of any error, please turn off the unit and contact the professionally skilled personnel.

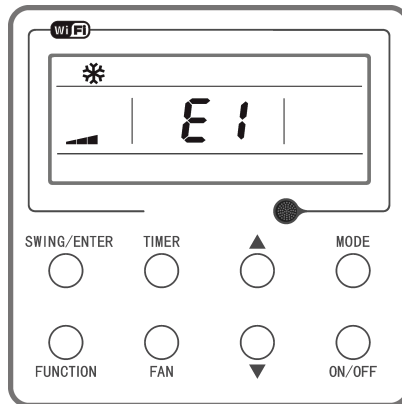

Fig.28

Table 4 Meaning of Each Error

Error	Error Code	Error	Error Code
Return air temperature sensor open/short circuited	F1	Drive board communication error	P6
evaporator temperature sensor open/short circuited	F2	Compressor overheating protection	H3
Indoor unit liquid valve temperature sensor open/short circuited	b5	Indoor and outdoor units unmatched	LP
Indoor gas valve temperature sensor open/short circuited	b7	Communication line misconnected or expansion valve error	dn
IPM temperature sensor open/short circuited	P7	Running mode conflict	E7
Outdoor ambient temperature sensor open/short circuited	F3	Pump-down	Fo
Outdoor unit condenser mid-tube temperature sensor open/short circuited	F4	Defrost or oil return	
Discharge temperature sensor open/short circuited	F5	Forced defrosting	H1
Indoor and outdoor communication error	E6	Compressor startup failure	Lc
DC bus under-voltage protection	PL	High discharge temperature protection	E4
DC bus over-voltage protection	PH	Overload protection	E8
Compressor phase current sensing circuit error	U1	Whole unit over-current protection	E5
Compressor demagnetization protection	HE	Over phase current protection	P5
PFC protection	Hc	Compressor desynchronizing	H7
IPM Temperature Protection	P8	IPM Current protection	H5
Over-power protection	L9	Compressor phase loss/reversal protection	Ld
System charge shortage or blockage protection	F0	Frequency restricted/reduced with whole unit current protection	F8
Capacitor charging error	PU	Frequency restricted/reduced with IPM current protection	En
High pressure protection	E1	Frequency restricted/reduced with high discharge temperature	F9
Low pressure protection	E3	Frequency restricted/reduced with anti-freezing protection	FH
Compressor stalling	LE	Frequency restricted/reduced with overload protection	F6
Over-speeding	LF	Frequency restricted/reduced with IPM temperature protection	EU
Drive board temperature sensor error	PF	Indoor unit full water error	E9
AC contactor protection	P9	Anti-freezing protection	E2
Temperature drift protection	PE	AC input voltage abnormal	PP
Sensor connection protection	Pd	Whole unit current sensing circuit error	U5
DC bus voltage drop error	U3	4-way valve reversing error	U7
Outdoor fan 1 error protection	L3	Motor stalling	H6
Outdoor fan 2 error protection	LA	PG motor zero-crossing protection	U8
compressor inhalation temperature sensor error	dc	Indoor fan tripping error	U0

Table 4 Meaning of Each Error

<b>Error</b>	<b>Error Code</b>	<b>Error</b>	<b>Error Code</b>
Communication error between IDU and grid connection	Ln	IDU network address error	y3
Communication error between ODU and grid connection	LM	Ip address allocation overflow	yb
Main error at grid connection side	y2		





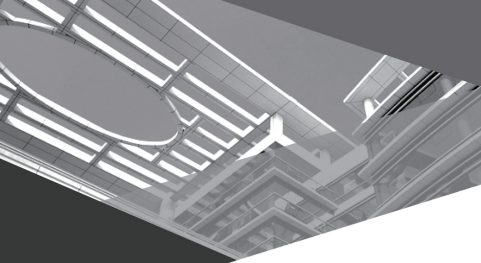

66139911825

