

LPM-30 TWO-STAGE 30KBTU EEM 96% AFUE FURNACE, NATURAL GAS TO LP GAS CONVERSION KIT INSTALLATION INSTRUCTIONS

ATTENTION INSTALLING PERSONNEL

As a professional installer, you have an obligation to know the product better than the customer. This includes all safety precautions and related items.

Prior to actual installation, thoroughly familiarize yourself with this Instruction Manual. Pay special attention to all safety warnings. Often during installation or repair, it is possible to place yourself in a position which is more hazardous than when the unit is in operation.

Remember, it is your responsibility to install the product safely and to know it well enough to be able to instruct a customer in its safe use.

Safety is a matter of common sense...a matter of thinking before acting. Most dealers have a list of specific good safety practices...follow them.

The precautions listed in this Installation Manual are intended as supplemental to existing practices. However, if there is a direct conflict between existing practices and the content of this manual, the precautions listed here take precedence.



RECOGNIZE THIS SYMBOL AS A SAFETY PRECAUTION

DESCRIPTION

This natural gas to L.P. (liquid petroleum) gas conversion kit allows White-Rodgers gas valve 36G54 (0151F00000P), 36J54 (0151M00027) or Honeywell VR9205Q (0151M00014 / 0151M00028) to be used on L.P. gas applications.

Use the following parts list to ensure that all parts listed below are present and in an undamaged condition. IF ANY DOUBT EXISTS ABOUT THE CONDITIONS OF ANY COMPONENT WITHIN THIS KIT, DO NOT USE THIS KIT AND CONTACT YOUR SUPPLIER FOR A NEW KIT.

PARTS LIST

Part Number	Description	Quantity
0163F00000P	White-Rodgers LP Conversion Kit F92-1008	1
0163M00139	Honeywell LP Conversion Kit 50033841	1
B14933151	Conversion Label	1
B25899-09	#57 Spud Orifice Assembly	1
IO-831	LPM-30 Installation Instructions	1
0151K00000S	36G54 Pressure Check Kit Valve	1

With the exception of the natural gas burner orifices, all of the fasteners and other components removed to perform this conversion are to be reused. Any component found to be damaged due to this conversion must be replaced with factory authorized replacement parts before this furnace can be put into operation.

This furnace is equipped for two-stage heating operation. The gas valve manifold pressure must be set with first stage operating at 6" +/-0.3" W.C. manifold pressure and the second stage must be set at 10" +/-0.3" W.C. manifold pressure. The accuracy of these pressures must be checked as shown in steps 25 and 26 of these instructions.

The gas valve is equipped with a 3-pin polarized plug which prevents this wiring from being installed incorrectly.



CAUTION

LABEL ALL WIRES PRIOR TO DISCONNECTION WHEN SERVICING CONTROLS. WIRING ERRORS CAN CAUSE IMPROPER AND DANGEROUS OPERATION. VERIFY PROPER OPERATION AFTER SERVICING.

NOTE: Do not use power tools for any adjustments on gas valves.



CONTENTS

Important Information	2
Conversion Instructions - WR 36G54 or 36J54 Valves	3
Conversion Instructions - HW VR9205Q Valve	5

The following tools and supplies are required:

- 2 – Pipe wrenches, properly sized to accommodate the gas piping and connectors
- 1 – 7/16" box wrench or socket wrench
- 1 - 1/4" nut driver
- 1 – 3/16" flat blade screwdriver
- 1 – 1/4" flat blade screwdriver
- 1 – 3/16" allen wrench
- 1 – manometer to read inlet and outlet pressure of the gas valve (Minimum range: 0"-20" W.C.)
- Pipe joint compound or pipe thread tape that is approved for use with L.P. gas
- Gas leak detection solution like a soap and water solution. Always wipe the solution from the joints when testing is completed.

 <b style="font-size: 1.2em;">WARNING
NEVER USE AN OPEN FLAME TO CHECK FOR GAS LEAKS.

Prior to performing this conversion, refer to the National Fuel Gas Code (NFPA 54-02) or in Canada, CAN/CSA-B149.2-05 to ensure that the installation is in compliance with those and all local codes.

IMPORTANT INFORMATION

 <b style="font-size: 1.2em;">WARNING	
HIGH VOLTAGE! DISCONNECT ALL POWER BEFORE SERVICING. MULTIPLE POWER SOURCES MAY BE PRESENT. FAILURE TO DO SO MAY CAUSE PROPERTY DAMAGE, PERSONAL INJURY OR DEATH.	

 <b style="font-size: 1.2em;">WARNING
CARBON MONOXIDE (CO) CAN CAUSE SEVER PERSONAL INJURY OR DEATH.

 <b style="font-size: 1.2em;">WARNING
THIS L.P. (LIQUID PETROLEUM) CONVERSION KIT MUST BE INSTALLED BY A QUALIFIED SERVICE PERSON OR AGENCY IN ACCORDANCE WITH THE MANUFACTURER'S INSTRUCTIONS AND ALL APPLICATION CODES AND REQUIREMENTS OF THE AUTHORITY HAVING JURISDICTION. FAILURE TO FOLLOW THESE INSTRUCTIONS EXPLICITLY MAY CAUSE A FIRE, EXPLOSION OR THE PRODUCTION OF CARBON MONOXIDE (CO), WHICH CAN CAUSE PROPERTY DAMAGE, PERSONAL INJURY OR DEATH. THE QUALIFIED PERSON PERFORMING THIS CONVERSION ASSUMES THE RESPONSIBILITY FOR THE PROPER CONVERSION OF THE APPLIANCE.

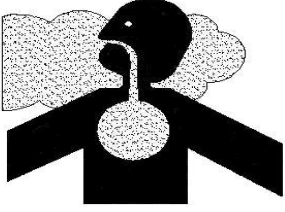
 <b style="font-size: 1.5em;">DANGER <b style="font-size: 1.2em;">PELIGRO

CARBON MONOXIDE POISONING HAZARD
Special Warning for Installation of Furnace or Air Handling Units in Enclosed Areas such as Garages, Utility Rooms or Parking Areas
<p>Carbon monoxide producing devices (such as an automobile, space heater, gas water heater, etc.) should not be operated in enclosed areas such as unventilated garages, utility rooms or parking areas because of the danger of carbon monoxide (CO) poisoning resulting from the exhaust emissions. If a furnace or air handler is installed in an enclosed area such as a garage, utility room or parking area and a carbon monoxide producing device is operated therein, there must be adequate, direct outside ventilation.</p> <p>This ventilation is necessary to avoid the danger of CO poisoning which can occur if a carbon monoxide producing device continues to operate in the enclosed area. Carbon monoxide emissions can be (re)circulated throughout the structure if the furnace or air handler is operating in any mode.</p>
<p>CO can cause serious illness including permanent brain damage or death.</p> <p style="text-align: right;">B10259-216</p>
RIESGO DE INTOXICACIÓN POR MONÓXIDO DE CARBONO
<p>Advertencia especial para la instalación de calentadores ó manejadoras de aire en áreas cerradas como estacionamientos ó cuartos de servicio.</p> <p>Los equipos ó aparatos que producen monóxido de carbono (tal como automóvil, calentador de gas, calentador de agua por medio de gas, etc) no deben ser operados en áreas cerradas debido al riesgo de envenenamiento por monóxido de carbono (CO) que resulta de las emisiones de gases de combustión. Si el equipo ó aparato se opera en dichas áreas, debe existir una adecuada ventilación directa al exterior. Esta ventilación es necesaria para evitar el peligro de envenenamiento por CO, que puede ocurrir si un dispositivo que produce monóxido de carbono sigue operando en el lugar cerrado.</p> <p>Las emisiones de monóxido de carbono pueden circular a través del aparato cuando se opera en cualquier modo.</p>
<p>El monóxido de carbono puede causar enfermedades severas como daño cerebral permanente ó muerte.</p> <p style="text-align: right;">B10259-216</p>
RISQUE D'EMPOISONNEMENT AU MONOXYDE DE CARBONE
<p>Avvertissement special au sujet de l'installation d'appareils de chauffage ou de traitement d'air dans des endroits clos, tels les garages, les locaux d'entretien et les stationnements.</p> <p>Evitez de mettre en marche les appareils produisant du monoxyde de carbone (tels que les automobile, les appareils de chauffage autonome, etc.) dans des endroits non ventilés tels que les d'emponnement au monoxyde de carbone. Si vous devez faire fonctionner ces appareils dans un endroit clos, assurez-vous qu'il y ait une ventilation directe provenant de l'exterieur.</p> <p>Cette ventilation est nécessaire pour éviter le danger d'intoxication au CO pouvant survenir si un appareil produisant du monoxyde de carbone continue de fonctionner au sein de la zone confinée.</p> <p>Les émissions de monoxyde de carbone peuvent être recirculés dans les endroits clos, si l'appareil de chauffage ou de traitement d'air sont en marche.</p>
<p>Le monoxyde de carbone peut causer des maladies graves telles que des dommages permanents au cerveau et même la mort.</p> <p style="text-align: right;">B10259-216</p>

WHITE-RODGERS 36G54 OR 36J54

CONVERSION INSTRUCTIONS



WARNING



HIGH VOLTAGE!

DISCONNECT ALL POWER BEFORE SERVICING.
MULTIPLE POWER SOURCES MAY BE PRESENT. FAILURE TO DO SO MAY CAUSE PROPERTY DAMAGE, PERSONAL INJURY OR DEATH.



CAUTION

TO PREVENT UNSATISFACTORY FURNACE OPERATION, THE PROPER GAS CONVERSION KIT MUST BE USED FOR THE GAS VALVE. USE THE WHITE-RODGERS SPRING KIT ONLY WITH THE WHITE-RODGERS GAS VALVE.

1. Turn off the gas supply to the furnace.
2. Turn off the electrical power to the furnace.
3. Remove the furnace control access panel.
4. Separate the gas supply union and remove associated downstream piping.
5. Always use a backup wrench when removing or replacing piping to avoid any undue strains or rotation of controls.
6. Remove the wires from the gas valve.
7. Remove the 4 sheet metal screws that fasten the manifold/gas valve assembly to the burner box.
8. Visually inspect orifices for damage and drill size (marked on face with #57) before installation. Using the 7/16" wrench, remove all existing natural gas orifices and replace with the appropriate #57 L.P. gas orifices contained in this kit. Tighten the orifices to prevent gas leaks, but do not overtighten. Retain the natural gas orifices for future reconversion.
9. Install water manometer using Valve Pressure Check Kit P/N 0151K00000S included with this kit. Using the included 3/32" hex wrench, rotate outlet pressure tap screw one revolution counterclockwise. Attach the included 5/16" hose to the inlet and outlet pressure boss of the valve. Hose should overlap boss 3/8". Connect 5/16" side of included connector to the hose on the outlet boss. Connect 1/4" side of the connector to the manometer hose. The manometer must have a scale range of at least 0" to 20" of water column.
10. Remove both regulator cover screws.
11. Using a 1/4" flat blade screwdriver, remove both regulator adjustment screws (beneath the cover screws).
12. Remove both Natural Gas regulator springs (color-coded silver/plain) from regulator sleeves and retain with the Natural Gas orifices for future reconversion.
13. Insert the L.P. regulator springs (provided in the conversion kit and color-coded white) into the regulator sleeves.
14. Replace the High regulator adjustment screw and adjust approximately 12 turns to the bottom stop.
15. Replace the Low regulator adjustment screw and adjust approximately 8 turns.

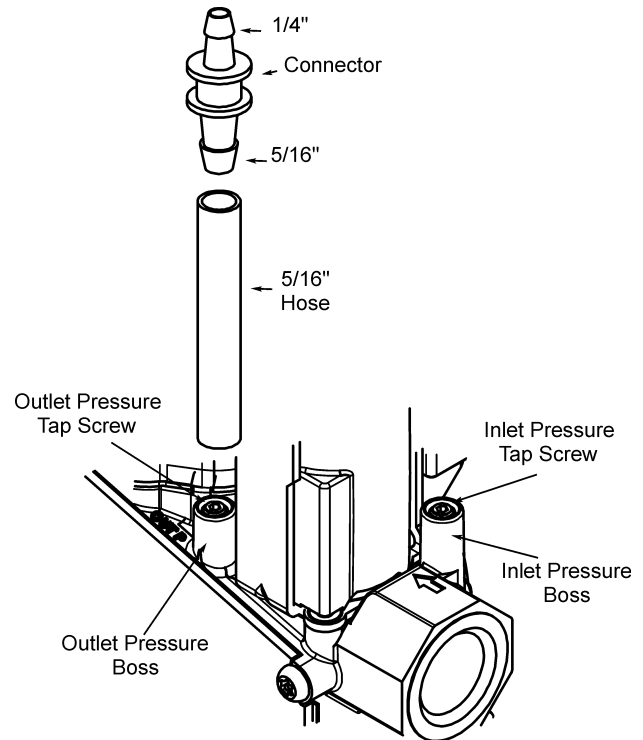

16. Reinstall the manifold/gas valve assembly into the appliance. Rewire the gas valve.
17. Apply a liberal amount of pipe joint compound or pipe thread tape to the threads and reassemble the piping previously removed.



WARNING

TO PREVENT THE POSSIBILITY OF GAS LEAKS, THE PIPE JOINT COMPOUND OR PIPE THREAD TAPE **MUST** BE RESISTANT TO L.P. GAS.

18. Turn on the gas supply.
19. Using a soap and water solution, check for leaks around the gas valve/manifold connection.
20. Turn on the electrical supply.
21. Adjust the room thermostat to obtain a first stage (W1 only) burner operation.



WARNING

NEVER USE AN OPEN FLAME TO CHECK FOR GAS LEAKS.

22. Using a soap and water solution, check for leaks around the gas valve/manifold connection and the burner orifices. Repair any leaks before continuing.
23. **NOTE:** Any other gas-fired equipment should be ON before any adjustments are made.
After the furnace has been in operation for 15 minutes, adjust the gas supply pressure (not manifold pressure) to obtain a range between 11" and 13" W.C. If the gas inlet pressure falls outside of this range, then make necessary L.P. service regulator(s) adjustments; check piping size, etc., and /or consult with L.P. provider.
24. With the furnace operating in its low-fire (W1) condition, the manifold pressure should be 6" W.C. \pm 0.30". If necessary, this pressure can be adjusted using the gas valve low regulator adjustment screw. Turn clockwise to increase

pressure and counterclockwise to decrease manifold pressure.

25. Readjust the room thermostat to obtain a second stage call for heat (W2). The manifold pressure for the W2 condition should be 10" W.C. ± 0.30" W.C. Adjustments to this pressure can be made using the high regulator adjustment screw.
26. Using the room thermostat to cycle the unit, observe a minimum of three (3) smooth ignition cycles.
27. Turn off gas and electrical supply to the furnace, remove the manometer hose from the pressure tap bosses, and tighten the inlet and outlet pressure tap screws using the 3/32" Allen wrench.
28. Replace both regulator cover screws on the regulator sleeve.

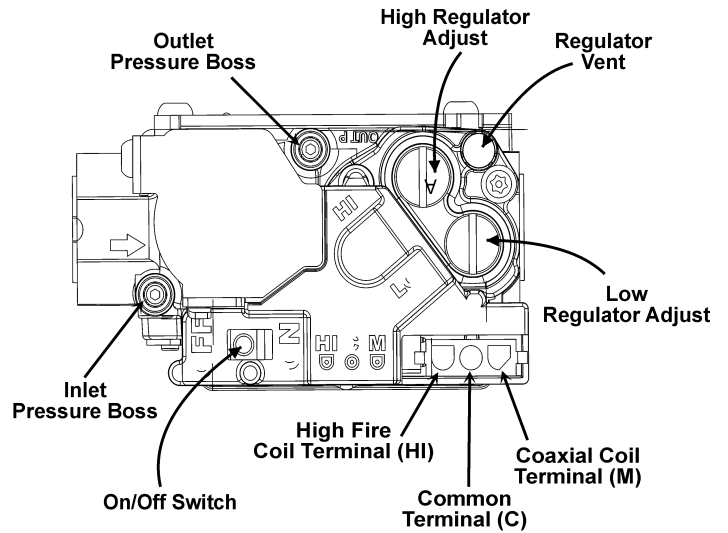

White-Rodgers 36G54 or 36J54

 WARNING
<p>ATTACH THE WARNING LABEL PROVIDED IN THE KIT TO THE GAS VALVE WHERE IT CAN BE READILY SEEN.</p> <p>ATTACH THE SMALL, ROUND L.P. LABELS TO THE TOP OF THE REGULATOR COVER SCREWS.</p>

29. **IMPORTANT NOTE:** Apply the conversion label (B14933-151) provided with the conversion kit. This label must be attached adjacent to the rating plate.
30. Reinstall the access panels.
31. Turn on the gas and electrical supply.
32. Reset all other appliances so they function normally.

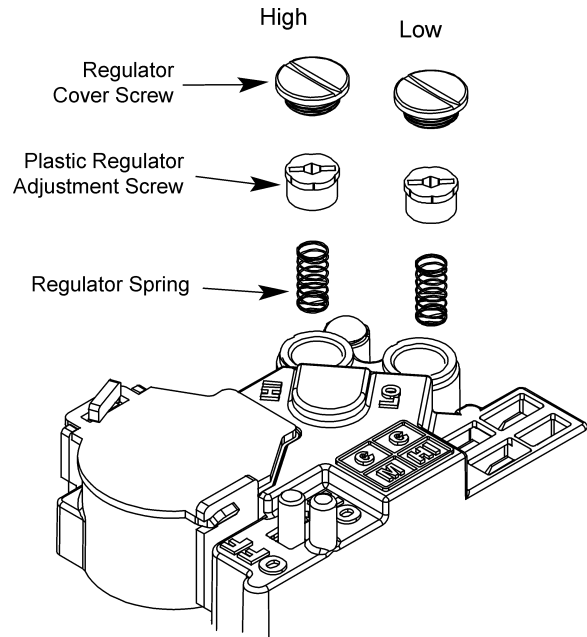

White-Rodgers 36G54 or 36J54 Springs and Regulator Screws

HONEYWELL VR9205Q

CONVERSION INSTRUCTIONS

 WARNING	
HIGH VOLTAGE! DISCONNECT ALL POWER BEFORE SERVICING. MULTIPLE POWER SOURCES MAY BE PRESENT. FAILURE TO DO SO MAY CAUSE PROPERTY DAMAGE, PERSONAL INJURY OR DEATH.	

 CAUTION
TO PREVENT UNSATISFACTORY FURNACE OPERATION, THE PROPER GAS CONVERSION KIT MUST BE USED FOR THE GAS VALVE. USE THE HONEYWELL SPRING KIT ONLY WITH THE HONEYWELL GAS VALVE.

1. Turn off the gas supply to the furnace.
2. Turn off the electrical power to the furnace.
3. Remove the furnace control access panel.
4. Separate the gas supply union and remove associated downstream piping.
5. Always use a backup wrench when removing or replacing piping to avoid any undue strains or rotation of controls.
6. Remove the wires from the gas valve.
7. Remove the 4 sheet metal screws that fasten the manifold/gas valve assembly to the burner box.
8. Visually inspect orifices for damage and drill size (marked on face with #57) before installation. Using the 7/16" wrench, remove all existing natural gas orifices and replace with the appropriate #57 L.P. gas orifices contained in this kit. Tighten the orifices to prevent gas leaks, but do not overtighten. Retain the natural gas orifices for future reconversion.
9. Remove both the inlet and outlet plugs on the gas valve, using the 3/16" allen wrench. Install the fittings, which accompany the manometers, into the 1/8" NPT holes of the gas valve. Connect the manometers to the barbed fittings.
10. Remove both regulator cover screws and retain with the Natural Gas orifices for future reconversion.
11. Using a T-25 Torx driver (L Torx tool included in kit) or 3/16" flat head screwdriver, remove both regulator adjustment screws.
12. Remove both silver colored Natural Gas regulator springs from the regulator sleeves and retain with the Natural Gas orifices for future reconversion.
13. Insert the L.P. regulator springs (provided in the conversion kit and color-coded red) into the regulator sleeves.
14. Install the high regulator adjustment screw provided with the kit by threading all the way down until lightly seated and then back off 1 1/2 turns.

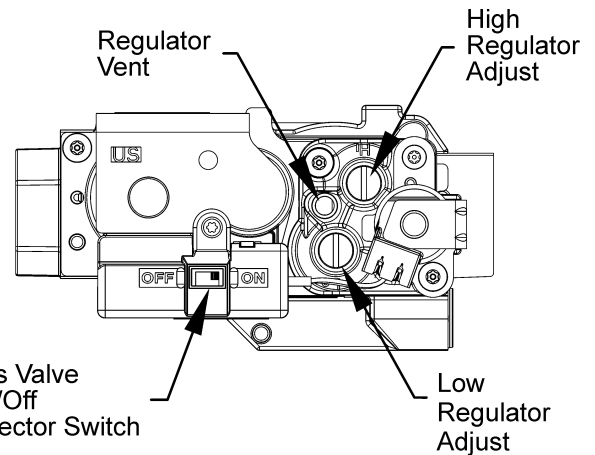

Honeywell VR9205Q

15. Install the low regulator adjustment screw provided with the kit by threading all the way down until lightly seated and then back off 1 1/2 turns.
16. Reinstall the manifold/gas valve assembly into the appliance. Rewire the gas valve.

 WARNING
TO PREVENT THE POSSIBILITY OF GAS LEAKS, THE PIPE JOINT COMPOUND OR PIPE THREAD TAPE MUST BE RESISTANT TO L.P. GAS.

17. Apply a liberal amount of pipe joint compound or pipe thread tape to the threads and reassemble the piping previously removed. **NOTE:** the pipe joint compound must be resistant to L.P. gas.
18. Turn on the gas supply.
19. Using a soap and water solution, check for leaks around the gas valve/manifold connection.
20. Turn on the electrical supply.
21. Adjust the room thermostat to obtain a first stage (W1 only) burner operation.
22. Using a soap and water solution, check for leaks around the gas valve/manifold connection and the burner orifices. Repair any leaks before continuing.

 WARNING
NEVER USE AN OPEN FLAME TO CHECK FOR GAS LEAKS.

23. **NOTE:** Any other gas-fired equipment should be ON before any adjustments are made.
 After the furnace has been in operation for 15 minutes, adjust the gas supply pressure (not manifold pressure) to obtain a range between 11" and 13" W.C. If the gas inlet pressure falls outside of this range, then make necessary L.P. service regulator(s) adjustments; check piping size, etc., and /or consult with local L.P. provider.
24. With the furnace operating in its low-fire (W1) condition, the manifold pressure should be 6" W.C. ± 0.30". If neces-

sary, this pressure can be adjusted using the low regulator adjustment screw. Turn clockwise to increase pressure and counterclockwise to decrease manifold pressure.

25. Readjust the room thermostat to obtain a second stage call for heat (W2). The manifold pressure for the W2 condition should be $10" \pm 0.30"$ W.C. Adjustments to this pressure can be made using the high regulator adjustment screw.
26. Using the room thermostat to cycle the unit, observe a minimum of three (3) smooth ignition cycles.
27. Turn off gas and electrical supply to the furnace. Remove the barbed manometer fittings from the $1/8"$ NPT holes in the gas valve. Seal inlet and outlet plugs removed earlier with pipe joint compound or pipe thread tape and reinstall.



WARNING

TO PREVENT THE POSSIBILITY OF GAS LEAKS, THE PIPE JOINT COMPOUND **MUST** BE RESISTANT TO L.P. GAS.

28. Install the regulator cover screws provided with the conversion kit.



WARNING

INSTALL THE **ATTENTION** LABEL PROVIDED WITH THE CONVERSION KIT TO THE GAS VALVE WHERE IT CAN BE READILY SEEN.

29. **IMPORTANT NOTE:** Apply the conversion label (B14933-151) provided with the conversion kit. This label must be attached adjacent to the rating plate.
30. Reinstall the access panels.
31. Turn on the gas and electrical supply.
32. Reset all other appliances so they function normally.

This page intentionally left blank.

NOTE: SPECIFICATIONS AND PERFORMANCE DATA LISTED HEREIN ARE SUBJECT TO CHANGE WITHOUT NOTICE

Quality Makes the Difference!

All of our systems are designed and manufactured with the same high quality standards regardless of size or efficiency. We have designed these units to significantly reduce the most frequent causes of product failure. They are simple to service and forgiving to operate. We use quality materials and components. Finally, every unit is run tested before it leaves the factory. That's why we know. . . **There's No Better Quality.**

Visit our website at www.daikincomfort.com, www.goodmanmfg.com or www.amana-hac.com for information on:

- Products
- Warranties
- Customer Services
- Parts
- Contractor Programs and Training
- Financing Options

5151 San Felipe, Suite 500, Houston, TX 77056

© 2014 Goodman Manufacturing Company, L.P.

Amana is a registered trademark of Maytag Corporation or its related companies and is used under license. All rights reserved.